

PRELIMINARY SPEC

Features

- SUITABLE FOR LEVEL INDICATORS.
- LOW CURRENT OPERATION.
- EXCELLENT ON/OFF CONTRAST.
- END STACKABLE.
- MECHANICALLY RUGGED.
- DIFFERENT COLORS IN ONE UNIT AVAILABLE.
- STANDARD: GRAY FACE, WHITE SEGMENT.
- RoHS COMPLIANT.

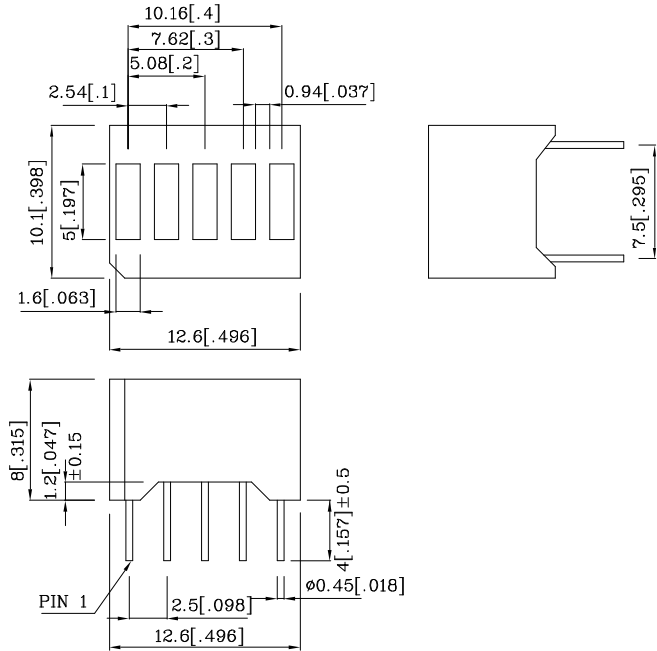
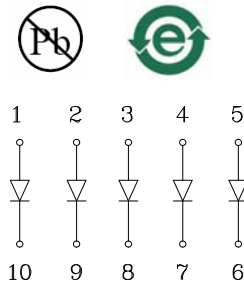

Notes:

1. All dimensions are in millimeters (inches).
2. Tolerance is $\pm 0.25(0.01")$ unless otherwise noted.
3. Specifications are subject to change without notice.

| Absolute Maximum Ratings (TA=25°C) | | UY (GaAsP/GaP) | Unit |
|--|-----------------------|-------------------|------|
| Reverse Voltage | V _R | 5 | V |
| Forward Current | I _F | 30 | mA |
| Forward Current (Peak) 1/10 Duty Cycle 0.1ms Pulse Width | i _{FS} | 140 | mA |
| Power Dissipation | P _T | 75 | mW |
| Operating Temperature | T _A | -40 ~ +85 | °C |
| Storage Temperature | T _{stg} | -40 ~ +85 | |
| Lead Solder Temperature [2mm Below Package Base] | 260°C For 3~5 Seconds | | |

| Operating Characteristics (TA=25°C) | | UY (GaAsP/GaP) | Unit |
|--|----------------|-------------------|------|
| Forward Voltage (Typ.) (I _F =10mA) | V _F | 1.95 | V |
| Forward Voltage (Max.) (I _F =10mA) | V _F | 2.5 | V |
| Reverse Current (Max.) (V _R =5V) | I _R | 10 | uA |
| Wavelength Of Peak Emission (Typ.) (I _F =10mA) | λ P | 590 | nm |
| Wavelength Of Dominant Emission (Typ.) (I _F =10mA) | λ D | 588 | nm |
| Spectral Line Full Width At Half-Maximum (Typ.) (I _F =10mA) | Δλ | 35 | nm |
| Capacitance (Typ.) (V _F =0V, f=1MHz) | C | 20 | pF |

| Part Number | Emitting Color | Emitting Material | Luminous Intensity (I _F =10mA) | | Wavelength nm λ P | Description |
|-------------|----------------|-------------------|---|------|-------------------------|-----------------------------|
| | | | min. | typ. | | |
| GUYX5D | Yellow | GaAsP/GaP | 1200 | 6105 | 590 | 5 Segments Bargraph-Display |



BAR GRAPH 5 SEGMENT

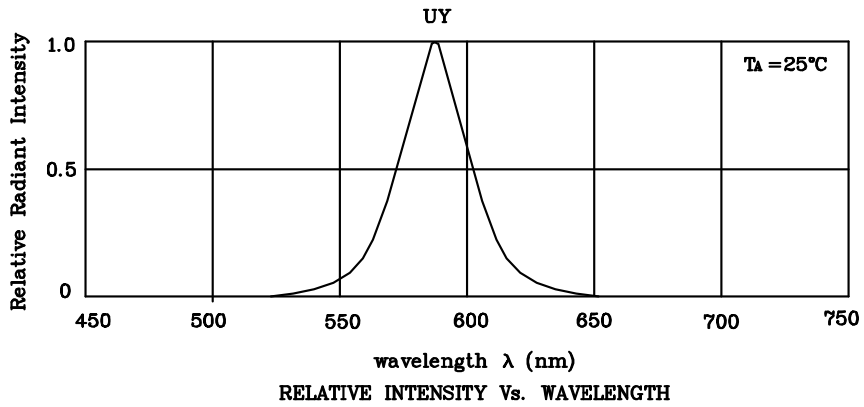

❖ UY

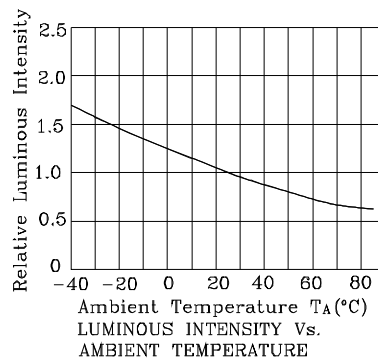
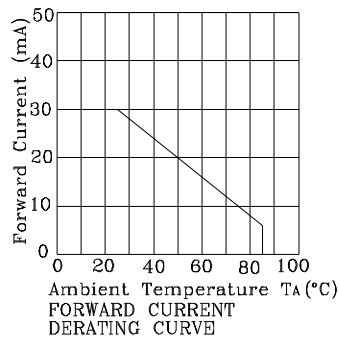
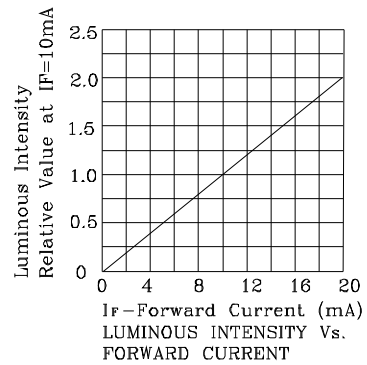
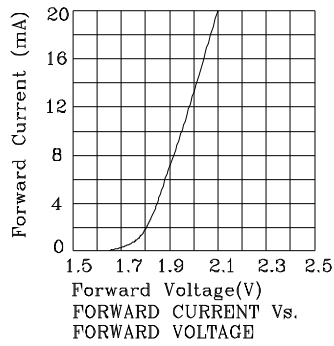

Wave Soldering Profile For Lead-free Through-hole LED.

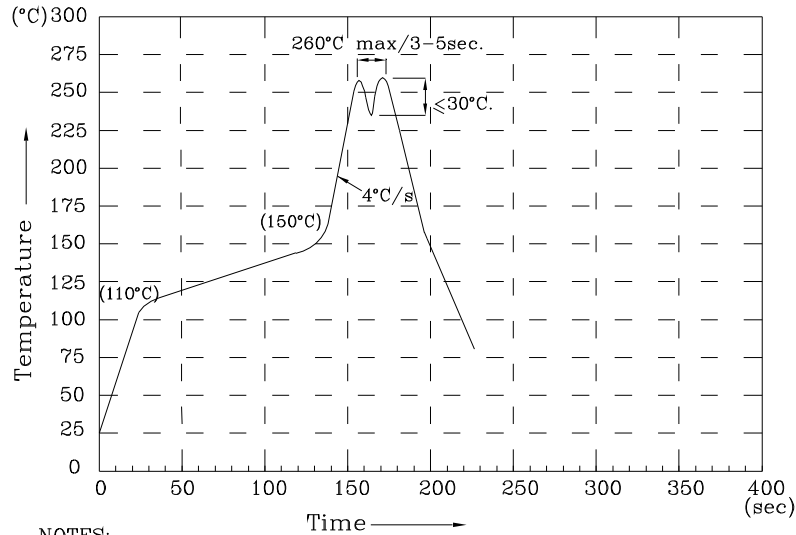

NOTES:

- 1.Recommend the wave temperature 245°C~260°C.The maximum soldering temperature should be less than 260°C.
- 2.Do not apply stress on epoxy resins when temperature is over 85 degree°C.
- 3.The soldering profile apply to the lead free soldering (Sn/Cu/Ag alloy).
- 4.No more than once.

Remarks:

If special sorting is required (e.g. binning based on forward voltage, luminous intensity / luminous flux or wavelength), the typical accuracy of the sorting process is as follows:

1. Wavelength: +/-1nm
2. Luminous Intensity / Luminous Flux: +/-15%
3. Forward Voltage: +/-0.1V

Note: Accuracy may depend on the sorting parameters.

PACKING & LABEL SPECIFICATIONS

GUYX5D

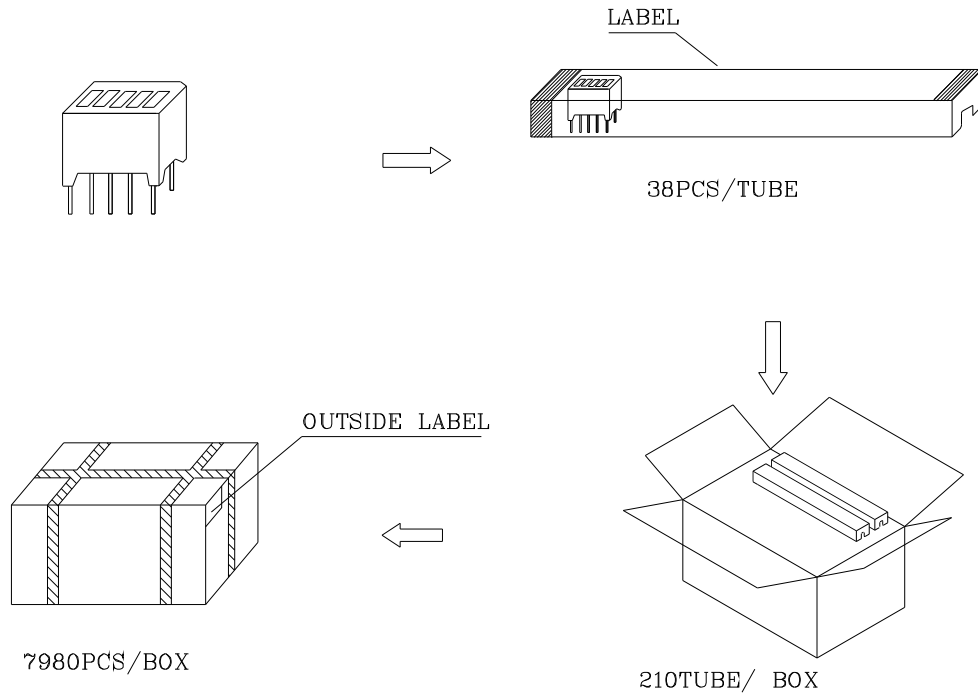

Inside LABEL Paste On The IC-tube

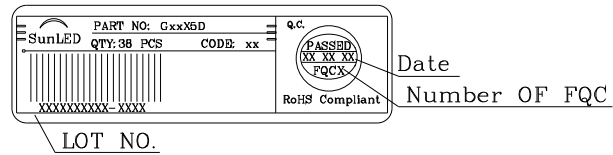

Outside LABEL Paste On The Box

