

5x7mm Surface Mount High Precision TCXO

In Stock at Digi-Key

CONNOR WINFIELD



2111 Comprehensive Drive

Aurora, Illinois 60505

Phone: 630-851-4722

Fax: 630-851-5040

www.conwin.com

US Headquarters

630-851-4722:

European Headquarters:

+353-61-472221

Description

The Connor-Winfield's D75AS is a 5x7mm Surface Mount Temperature Compensated Crystal Controlled Oscillators (TCXO) with a clipped sinewave output. Through the use of Analog Temperature Compensation, the D75AS is capable of holding sub 0.25-ppm stabilities over the 0 to 70°C temperature range.

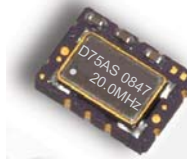

Features

Model D75AS

TCXO
3.3V Operation
Clipped Sinewave Output
Frequency Stability: ± 0.25 ppm
Temperature Range: 0 to 70°C
Low Jitter < 1ps RMS
Tri-State Enable/Disable Function
5x7mm Surface Mount Package
Tape and Reel Packaging
RoHS Compliant / Lead Free

Absolute Maximum Ratings

Parameter	Minimum	Nominal	Maximum	Units	Note
Storage Temperature	-55	-	85	°C	
Supply Voltage (Vcc)	-0.5	-	6.0	Vdc	
Input Voltage	-0.5	-	Vcc+0.5	Vdc	

Operating Specifications

Parameter	Minimum	Nominal	Maximum	Units	Note
Frequencies Available (Fo)		20.0		MHz	
Frequency Calibration @ 25 C	-1.00	-	1.00	ppm	1
Frequency Stability $[\pm(F_{max} - F_{min})/2.F_o]$	-0.25	-	0.25	ppm	2
Supply Voltage Variation (Vcc $\pm 5\%$)	-0.025	-	0.025	ppm	
Load Coefficient ($\pm 5\%$)	-0.025	-	0.025	ppm	
Static Temperature Hysteresis	-	-	0.40	ppm	Absolute, 3
Frequency shift after reflow soldering	-1.00	-	1.00	ppm	4
Total Frequency Tolerance	-4.60	-	4.60	ppm	5
Temperature Range	0	-	70	C	
Supply Voltage (Vcc)	3.135	3.3	3.465	Vdc	
Supply Current (Icc)	-	-	10	mA	
Period Jitter	-	3	5	ps rms	
Phase Jitter (BW=12kHz to 20MHz)	-	0.5	1	ps rms	
SSB Phase Noise at 10Hz offset	-	-80	-	dBc/Hz	
SSB Phase Noise at 100Hz offset	-	-110	-	dBc/Hz	
SSB Phase Noise at 1KHz offset	-	-135	-	dBc/Hz	
SSB Phase Noise at ≥ 10 KHz offset	-	-150	-	dBc/Hz	

Input Characteristics For Enable / Disable Function (Pin 8)

Parameter	Minimum	Nominal	Maximum	Units	Note
Enable Voltage (High) or open circuit (Vih)	70%Vcc	-	-	Vdc	6
Disable Voltage (Low) Output Disabled (Vil)	-	-	30%Vcc	Vdc	

Clipped Sinewave Output Characteristics

Parameter	Minimum	Nominal	Maximum	Units	Note
Output Voltage	1.00	-	-	V pk-pk	7
Output Load Resistance	-	10K	-	Ohms	
Output Load Capacitance	-	10	-	pF	8

Note:

- 1) Initial calibration @ 25 C. Specifications at time of shipment after 48 hours of operation
- 2) Frequency stability vs. change in temperature.
- 3) Frequency change after reciprocal temperature ramped over the operating range. Frequency measured before and after at 25°C.
- 4) Within two hours after reflow.
- 5) Inclusive of calibration @ 25 C, frequency vs. change in temperature, change in supply voltage ($\pm 5\%$), load change ($\pm 5\%$), reflow soldering process and 20 years aging, referenced to Fo.
- 6) Leave Pad 8 unconnected if enable / disable function is not required. When tri-stated, the output stage is disabled but the oscillator and compensation circuit are still active (current consumption ≤ 1 mA).
- 7) Output is AC coupled.
- 8) For best performance it is recommended that the circuit connected to this output should have an equivalent input capacitance of 10pF.



Bulletin Tx243

Page 1 of 2

Revision 00

Date 21 Oct 2008

Package Characteristics

Package Ceramic Surface Mount Package.

Environmental Characteristics

Vibration:	Vibration per Mil Std 883E Method 2007.3 Test Condition A
Shock:	Mechanical Shock per Mil Std 883E Method 2002.4 Test Condition B.
Soldering:	SMD product suitable for Convection Reflow soldering. Peak temperature 260 C. Maximum time above 220 C, 60 seconds.
Solderability	Solderability per Mil Std 883E Method 2003

Design Recommendations

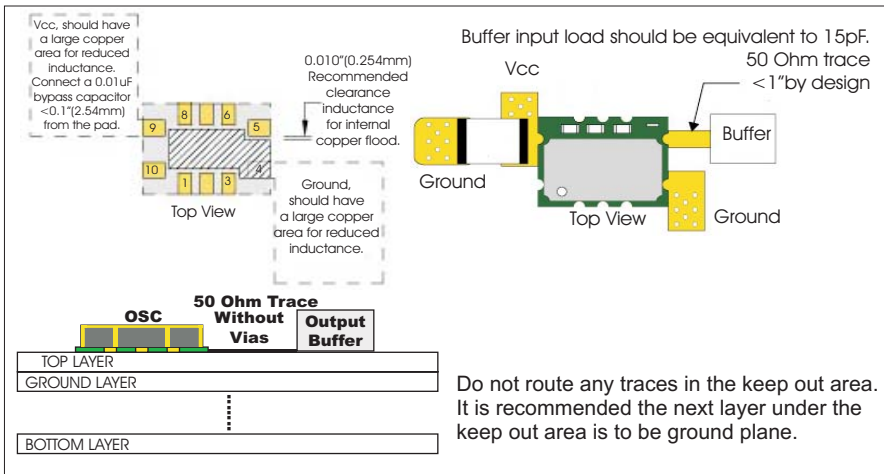

Vcc should have a large copper area for reduced inductance. Connect a 0.01 uF bypass capacitor <math><0.1 (2.54\text{mm})</math> from the pad.

0.010" (0.254mm) Recommended clearance inductance for internal copper flood.

Ground should have a large copper area for reduced inductance.

Buffer input load should be equivalent to 15pF. 50 Ohm trace <math><1" (by design)</math>

Do not route any traces in the keep out area. It is recommended the next layer under the keep out area is to be ground plane.

Ordering Information

D75AS - 020.0MHZ *

TCXO SERIES CENTER FREQUENCY

* For the tape and reel option, add -T to the end of the part number. Example: D75AS-020.0 MHZ -T

Pad Connections

Pad	Connection
1	Do not connect
2	Do not connect
3	Do not connect
4	Ground
5	Output
6	Do not connect
7	Do not connect
8	Enable / Disable
9	Supply, Vcc
10	Do not connect

Output Waveform

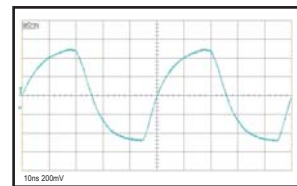

Package Layout

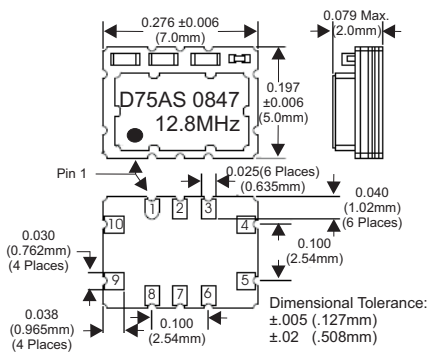

Suggested Pad Layout

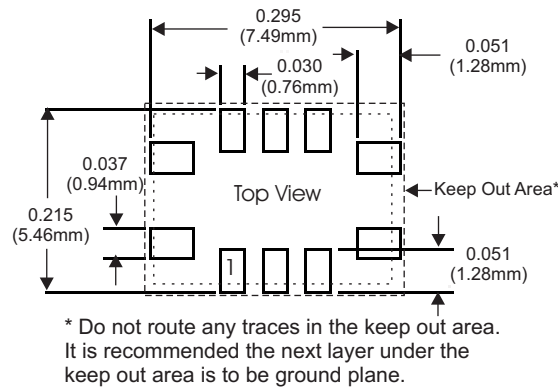

Test Circuit

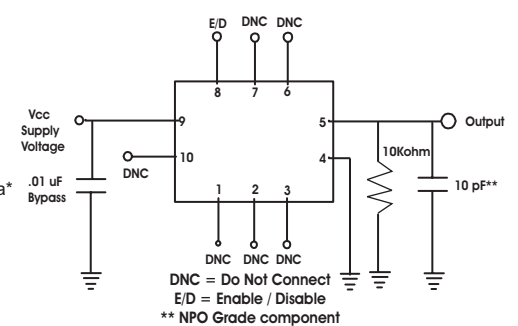

Tape and Reel Information

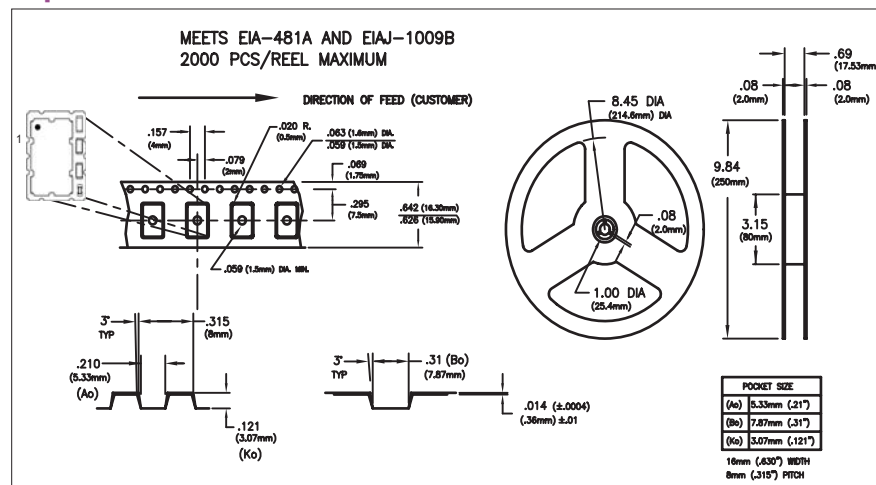

Solder Profile

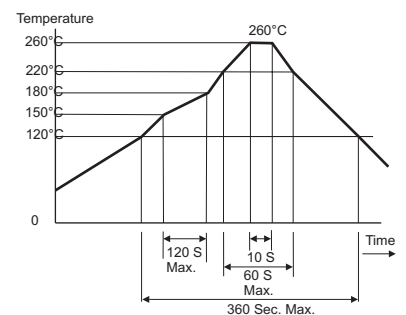

US Headquarters:
630-851-4722
European Headquarters:
+353-61-472221

Bulletin	Tx243
Page	2 of 2
Revision	00
Date	21 Oct 2008