

PCA4979

Converter from 80-pin 0.65mm-pitch QFP (80P6S-A) to 40-pin DIL Standard Pitch

Function

The PCA4979 is a board that converts an 80-pin 0.65mm-pitch QFP (80P6S-A) to the standard pitch. Pin No. 1 corresponds to pin No. 1.

Application

Use the PCA4979 as a test board to connect an 80P6S-A MCU package to a standard pitch universal board. Since an 80P6S-A IC socket (IC51-0804-711 made by Yamaichi Electronics Co., Ltd.) is mounted on the PCA4979, it is easy to replace MCUs.

Dimensions

58.0(D)×62.0(W)×20.0(H)mm

(L)=50.8(2.54×20)mm

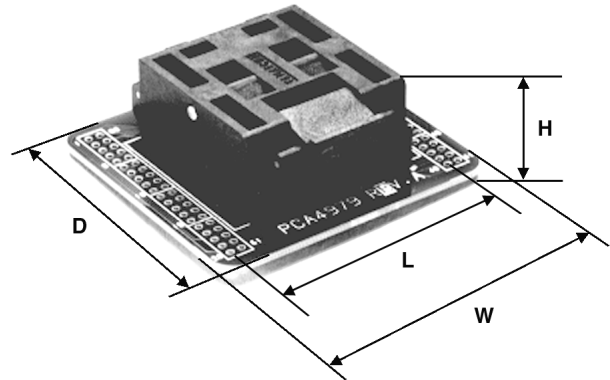

Pin Layout

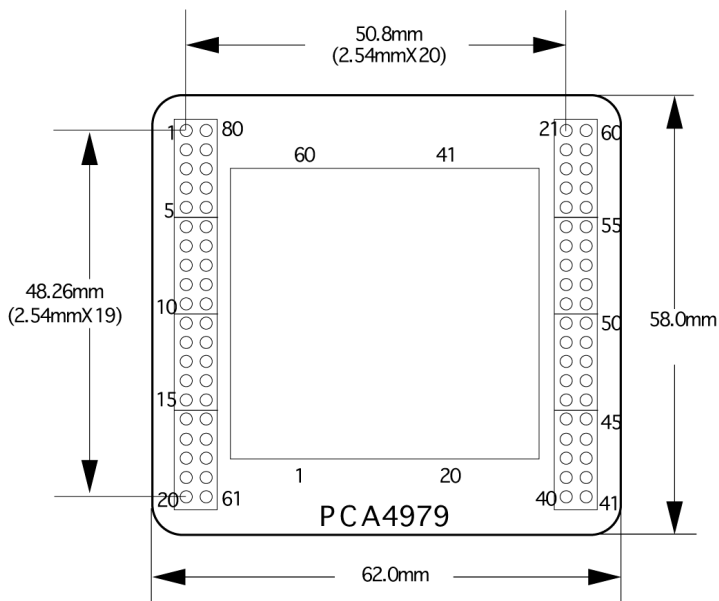

* Pins and other parts needed to connect the standard pitch converter are not included with the product.

[Ordering Information] See Appendix H "Ordering Information".

PCA4981A

Converter from 80-pin 0.8mm-pitch QFP (80P6-B) to 40-pin DIL Standard Pitch

Function

The PCA4981A is a board that converts an 80-pin 0.8mm-pitch QFP (80P6-B) to the standard pitch. Pin No. 1 corresponds to pin No. 1.

Application

Use the PCA4981A as a test board to connect an 80P6-B MCU package to a standard pitch universal board. Since an 80P6-B IC socket (IC51-819.KS-8075 made by Yamaichi Electronics Co., Ltd.) is mounted on the PCA4981 BARE, it is easy to replace MCUs.

Dimensions

55.0(D)×60.0(W)×20.0(H)mm
 (L)=50.8(2.54×20)mm

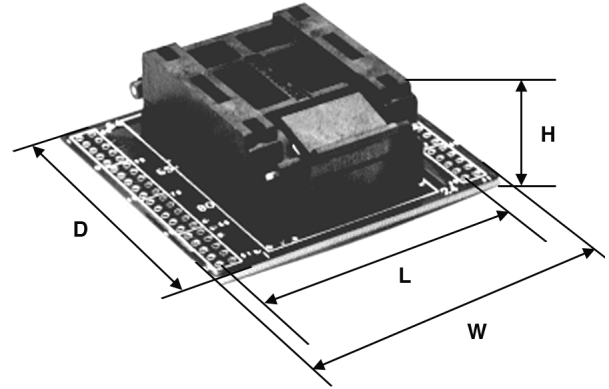

Pin Layout

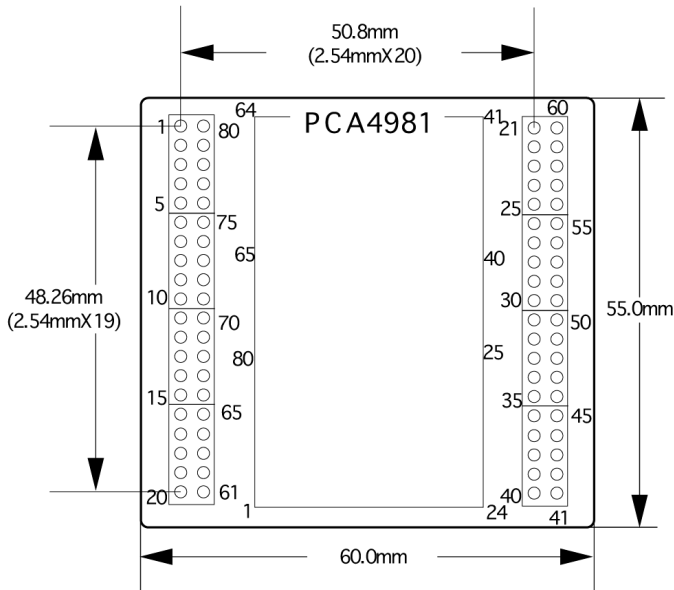

* Pins and other parts needed to connect the standard pitch converter are not included with the product.

[Ordering Information] See Appendix H "Ordering Information".

PCA4981B

Converter from 80-pin 0.8mm-pitch LCC (80D0) to 40-pin DIL Standard Pitch (with IC Socket)

Function

The PCA4981B is a board that converts an 80-pin 0.8mm-pitch LCC (80D0) to the standard pitch. Pin No. 1 corresponds to pin No. 1.

Application

Use the PCA4981B as a test board to connect an 80D0 MCU package to a standard pitch universal board. Since an 80D0 IC socket (IC51-0804-890 made by Yamaichi Electronics Co., Ltd.) is mounted on the PCA4981 BARE, it is easy to replace MCUs.

Dimensions

55.0(D)×60.0(W)×20.0(H)mm
(L)=50.8(2.54×20)mm

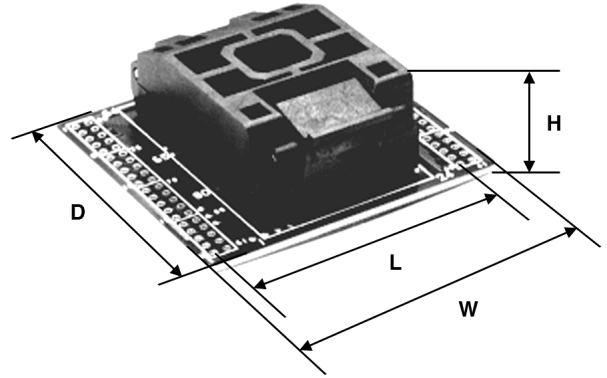

Pin Layout

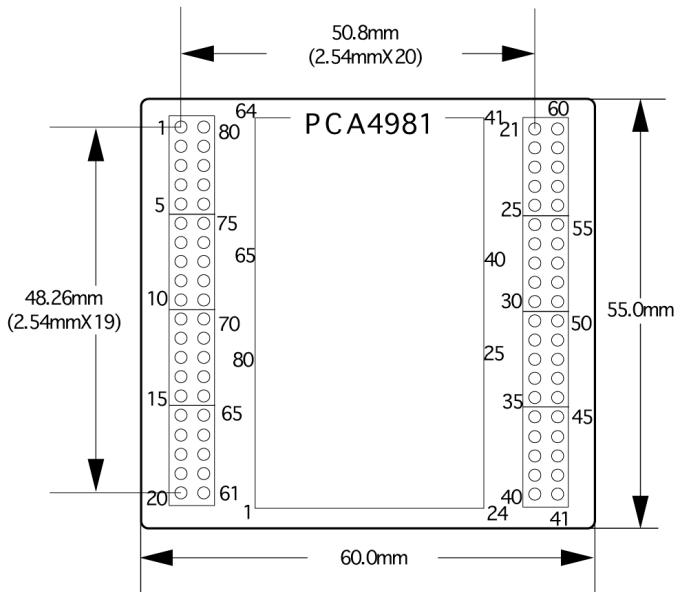

* Pins and other parts needed to connect the standard pitch converter are not included with the product.

[Ordering Information] See Appendix H "Ordering Information".

PCA4981C

Converter from 80-pin 0.8mm-pitch QFP (80P6N-A) to 40-pin DIL Standard Pitch

Function

The PCA4981C is a board that converts an 80-pin 0.8mm-pitch QFP (80P6N-A) to the standard pitch. Pin No. 1 corresponds to pin No. 1.

Application

Use the PCA4981C as a test board to connect an 80P6N-A MCU package to a standard pitch universal board. Since an 80P6N-A IC socket (IC51-0804-819-6 made by Yamaichi Electronics Co., Ltd.) is mounted on the PCA4981 BARE, it is easy to replace MCUs.

Dimensions

55.0(D)×60.0(W)×20.0(H)mm
(L)=50.8(2.54×20)mm

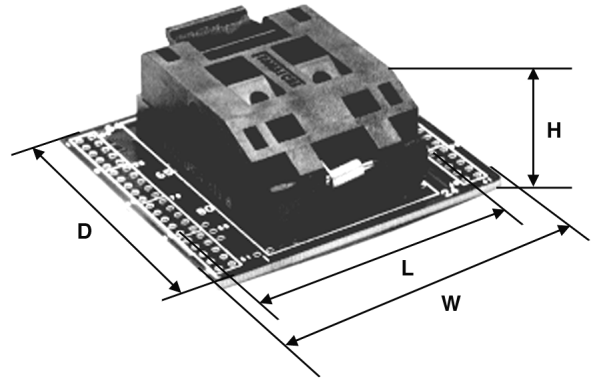

Pin Layout

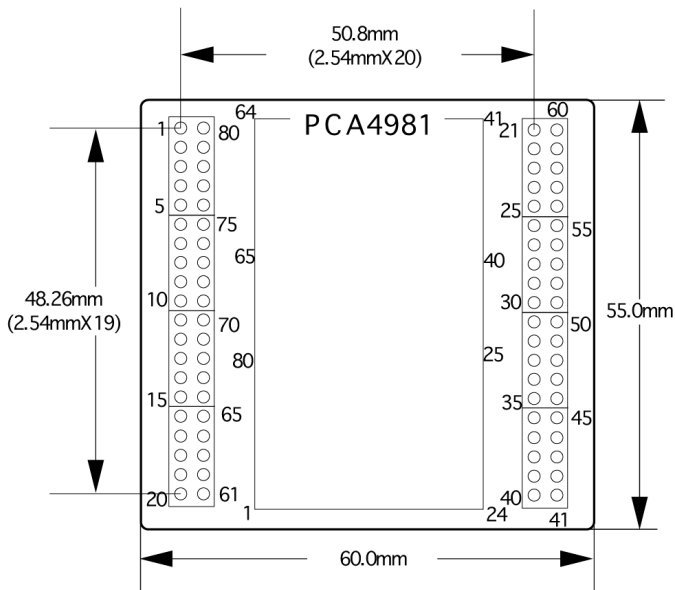

* Pins and other parts needed to connect the standard pitch converter are not included with the product.

[Ordering Information] See Appendix H "Ordering Information".

PCA4981 BARE

Converter from 80-pin 0.8mm-pitch QFP (80P6-B or 80P6N-A) or LCC (80D0) to 40-pin DIL Standard Pitch

Function

The PCA4981 BARE is a board that converts an 80-pin 0.8mm-pitch QFP (80P6-B or 80P6N-A) or LCC (80D0) to the standard pitch. Pin No. 1 corresponds to pin No. 1.

Application

Use the PCA4981 BARE as a test board to connect an 80P6-B, 80P6N-A or 80D0 MCU package to a standard pitch universal board. A cover-fitted IC socket made by Yamaichi Electronics Co., Ltd. is required.

Dimensions

55.0(D)×60.0(W)mm
(L)=50.8(2.54×20)mm

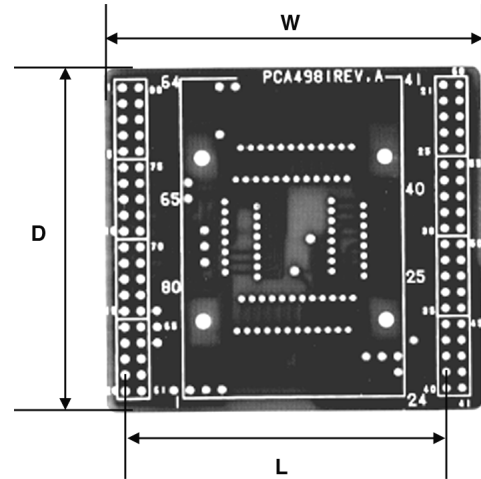

Pin Layout

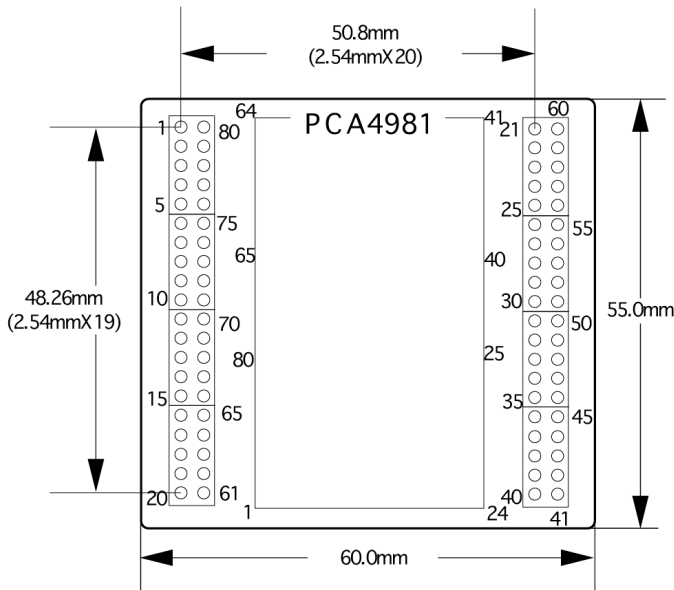

Manufactured Product

- For 80P6-B: PCA4981A
- For 80P6N-A: PCA4981C
- For 80D0: PCA4981B

[Ordering Information] See Appendix H "Ordering Information".

PCA4988

Converter from 80-pin 0.8mm-pitch LCC (80D0) to 40-pin DIL Standard Pitch (with LCC Socket)

Function

The PCA4988 is a board that converts an 80-pin 0.8mm-pitch LCC (80D0) to the standard pitch. Pin No. 1 corresponds to pin No. 1.

Application

Use the PCA4988 as a test board to connect an 80D0 MCU package to a standard pitch universal board. The PCA4988 has an 80-pin LCC socket mounted on its board.

Dimensions

50.0(D)×45.0(W)×6.5(H)mm

(L1)=35.56(2.54×14)mm

(L2)=38.1(2.54×15)mm

(L3)=17.78(2.54×7)mm

(L4)=27.94(2.54×11)mm

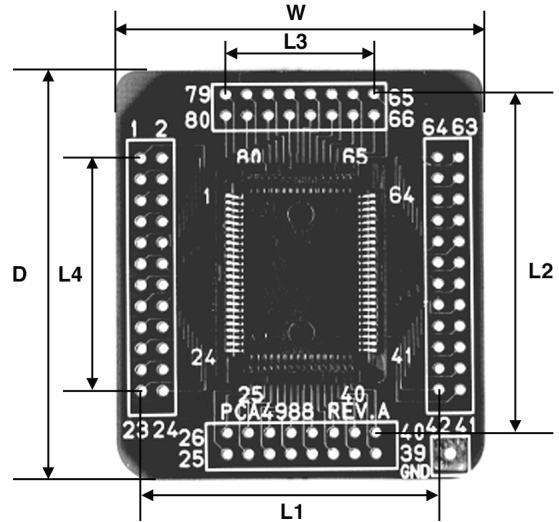

Pin Layout

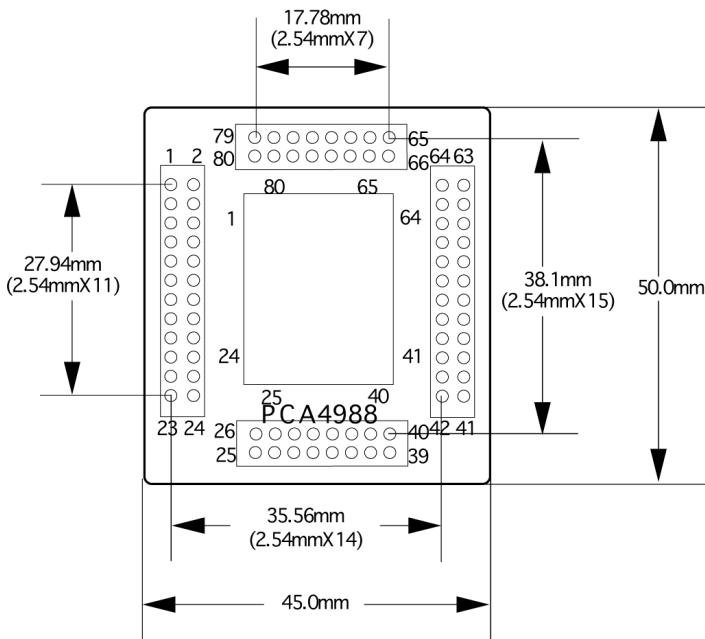

* Pins and other parts needed to connect the standard pitch converter are not included with the product.

[Ordering Information] See Appendix H "Ordering Information".

PCA4989

Converter from 80-pin 0.65mm-pitch QFP (80P6S-A) to 40-pin DIL Standard Pitch (Different Pin Layout from the PCA4979)

Function

The PCA4989 is a board that converts an 80-pin 0.65mm-pitch QFP (80P6S-A) to the standard pitch.

Application

Use the PCA4989 as a test board to connect an 80P6S-A MCU package to a standard pitch universal board. Since an 80P6S-A IC socket (IC51-0804-711 made by Yamaichi Electronics Co., Ltd.) is mounted on the PCA4989, it is easy to replace MCUs.

As the pin layout of the PCA4989 is that of the PCA4979 with two displaced pins, pin No. 1 of 80P6S-A IC socket of the PCA4989 corresponds to pin No. 3 of the standard pitch hole.

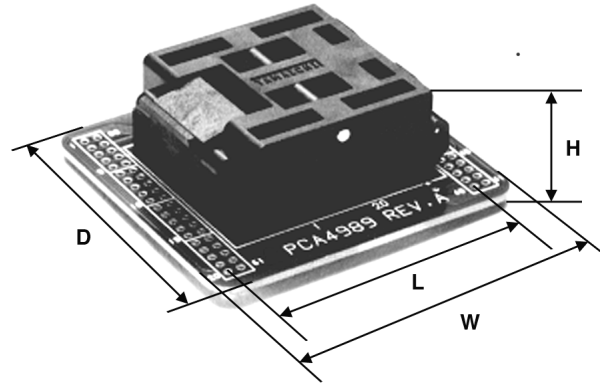

Dimensions

58.0(D)×62.0(W)×20.0(H)mm

(L)=50.8(2.54×20)mm

Pin Layout

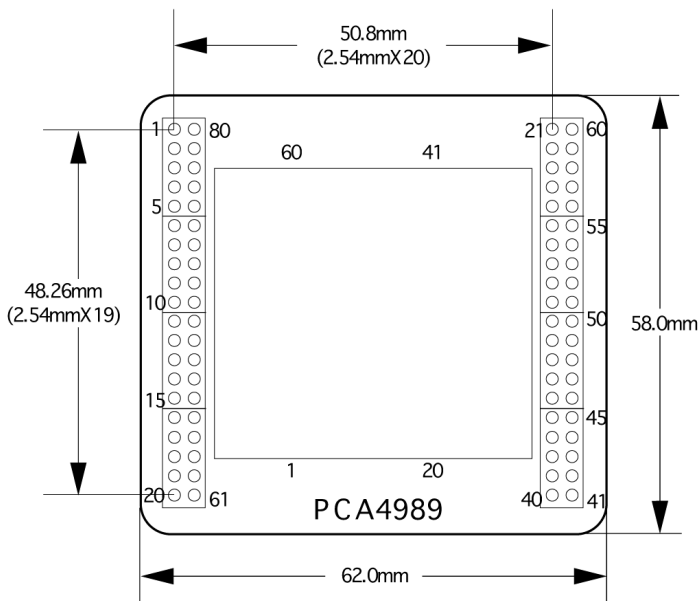

* Pins and other parts needed to connect the standard pitch converter are not included with the product.

[Ordering Information] See Appendix H "Ordering Information".

PCA7750G02

Converter board from 80-pin 0.8mm-pitch LCC (80D0) to 40-pin DIL Standard Pitch (with LCC Socket and the Pattern for Oscillator)

Function

The PCA7750G02 is a converter board that converts an 80-pin 0.8mm-pitch LCC (80D0) to the standard pitch. Pin No. 1 corresponds to pin No. 1.

Application

Use the PCA7750G02 as a test board to connect an 80D0 MCU package to a standard pitch universal board. The PCA7750G02 has an 80-pin LCC socket mounted on the PCA7750G02-BARE.

Dimensions

70.0(D)×64.0(W)×8.0(H)mm
 (L)=50.8(2.54×20)mm

Pin Layout

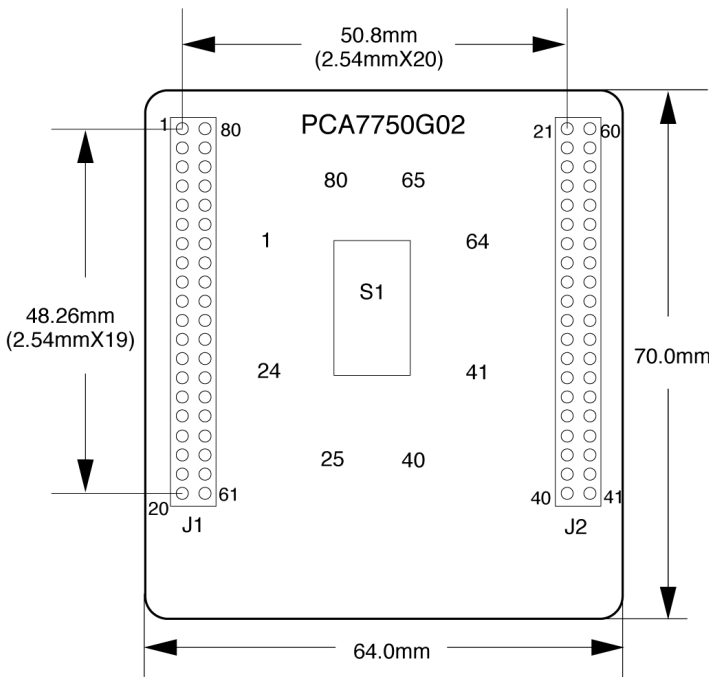
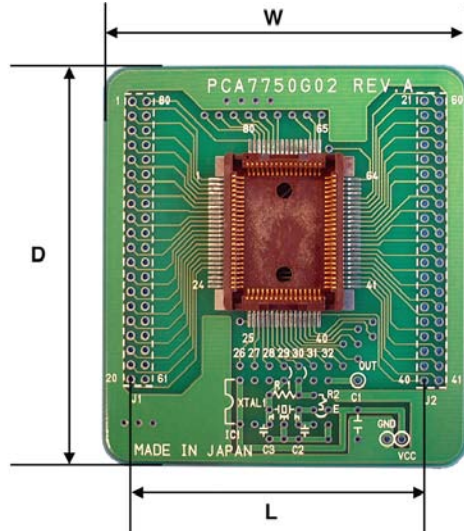

* Pins and other parts needed to connect the standard pitch converter are not included with the product.

[Ordering Information] See Appendix H "Ordering Information".

PCA7752AG02

Converter board from 100-pin 0.65mm-pitch LCC (100D0) to 50-pin DIL Standard Pitch (with LCC Socket)

Function

The PCA7752AG02 is a converter board that converts a 100-pin 0.65mm-pitch LCC (100D0) to the standard pitch. Pin No. 1 corresponds to pin No. 1.

Application

Use the PCA7752A as a test board to connect a 100D0 MCU package to a standard pitch universal board. The PCA7752A has a 100-pin LCC socket mounted on the PCA7752AG02-BARE.

Dimensions

70.0(D)×64.0(W)×8.0(H)mm
(L)=50.8(2.54×20)mm

Pin Layout

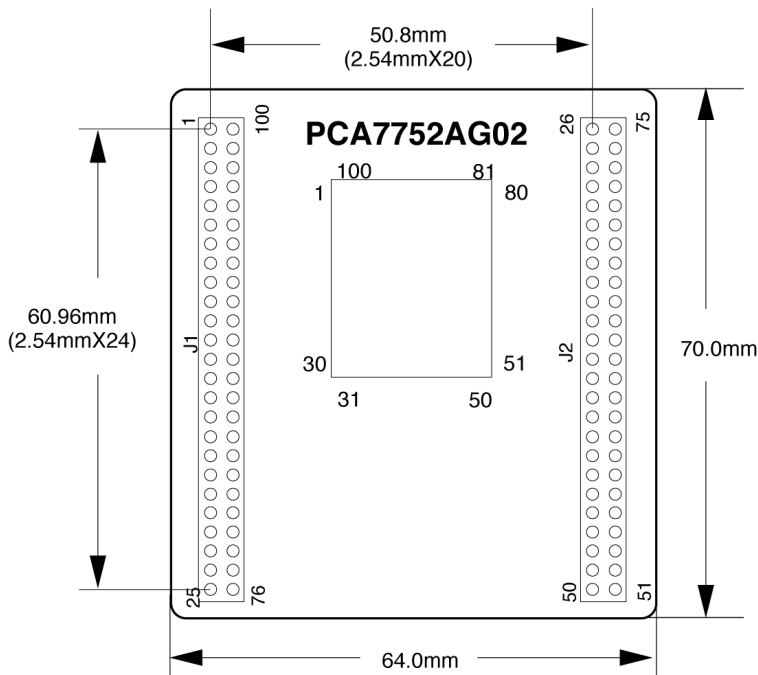
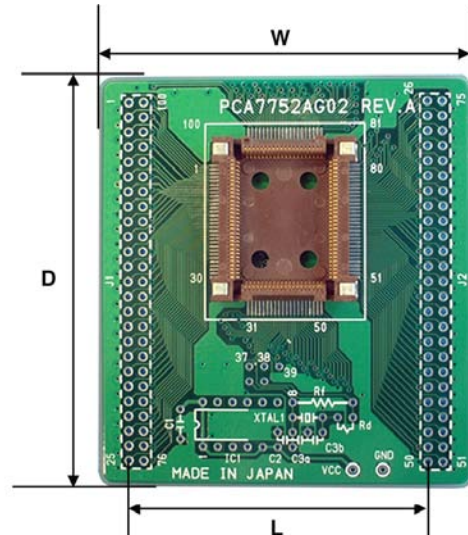

* Pins and other parts needed to connect the standard pitch converter are not included with the product.

[Ordering Information] See Appendix H "Ordering Information".

PCA7752AG02-BARE

Converter board from 100-pin 0.65mm-pitch QFP (100P6S-A) or LCC (100D0) to 50-pin DIL Standard Pitch

Function

The PCA7752AG02-BARE is a converter board that converts a 100-pin 0.65mm-pitch QFP (100P6S-A) or LCC (100D0) to the standard pitch. Pin No. 1 corresponds to pin No. 1.

Application

Use the PCA7752AG02-BARE as a test board to connect a 100P6S-A or 100D0 MCU package to a standard pitch universal board. Since the PCA7752A-BARE has a flat mounting pattern, users can mount a PROM MCU directly on it. A 100-pin LCC socket made by Yamaichi Electronics Co., Ltd. is required, when an MCU package is 100D0.

Dimensions

70.0(D)×64.0(W)mm

(L)=50.8(2.54×20)mm

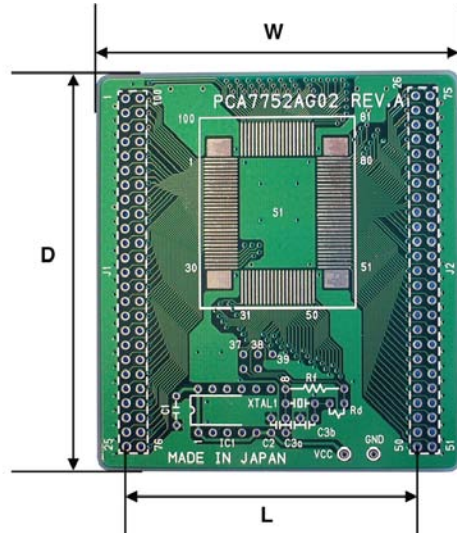

Pin Layout

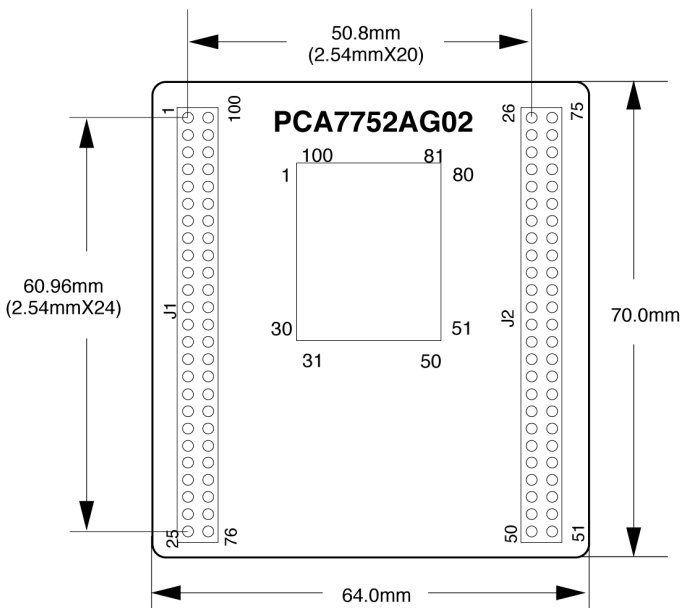

Foot Pattern Reference Dimensions

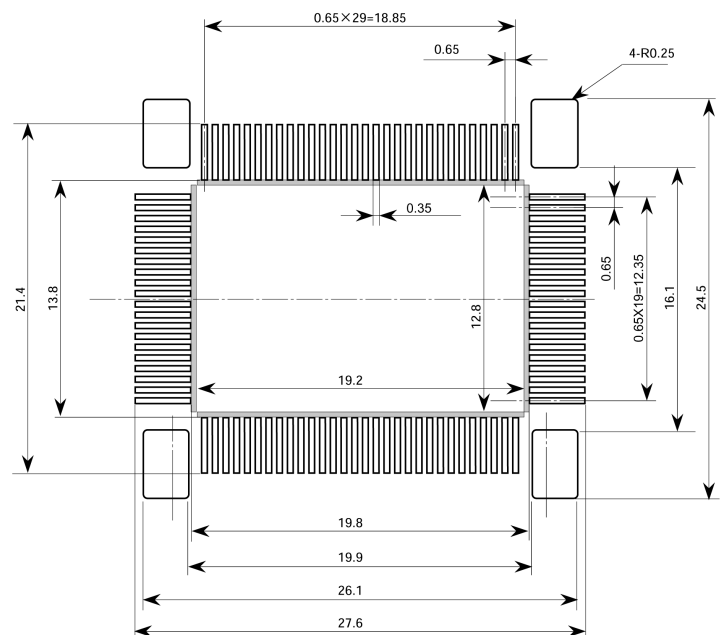

Manufactured Product

For 100P6S-A: PCA7752B

For 100D0: PCA7752AG02

[Ordering Information] See Appendix H "Ordering Information".

* When using the AXS4003M295C made by Matsushita Electric Works, Ltd., note that the contacts of the IC socket proper touch the PC board in the shaded section. Therefore, be especially careful with pattern wiring to ensure that other pins will not be shorted. (Through holes are not accepted.)

* Only when using the AXS4003M295C made by Matsushita Electric Works, Ltd. and IC61-1004-051 made by Yamaichi Electronics Co., Ltd., be sure to create foot patterns for the holding metal fixtures in four locations.

PCA7752B

Converter from 100-pin 0.65mm-pitch QFP (100P6S-A) to 50-pin DIL Standard Pitch

Function

The PCA7752B is a board that converts a 100-pin 0.65mm-pitch QFP (100P6S-A) to the standard pitch. Pin No. 1 corresponds to pin No. 1.

Application

Use the PCA7752B as a test board to connect a 100P6S-A MCU package to a standard pitch universal board. Since a 100P6S-A IC socket (IC51-1004-814-6 made by Yamaichi Electronics Co., Ltd.) is mounted on the PCA7752B, it is easy to replace MCUs.

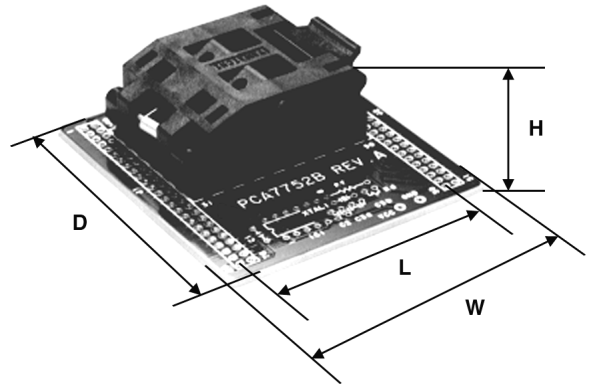

Dimensions

70.0(D)×64.0(W)×21.0(H)mm

(L)=50.8(2.54×20)mm

Pin Layout

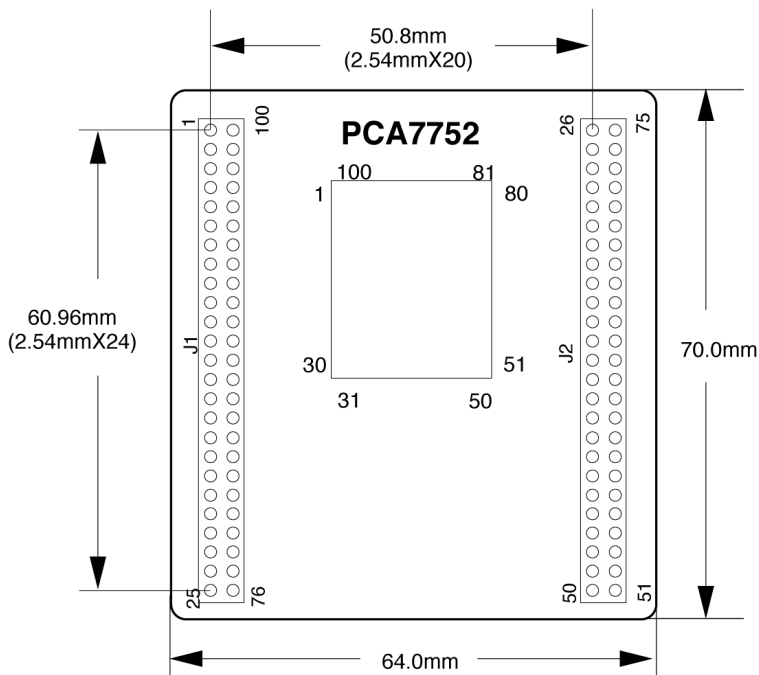

* Pins and other parts needed to connect the standard pitch converter are not included with the product.

[Ordering Information] See Appendix H "Ordering Information".

PCA7754

Converter from 100-pin 0.5mm-pitch QFP (100P6Q-A) to 50-pin DIL Standard Pitch

Function

The PCA7754 is a board that converts a 100-pin 0.5mm-pitch QFP (100P6Q-A to formerly 100P6D-A) to the standard pitch. Pin No. 1 corresponds to pin No. 1.

Application

Use the PCA7754 as a test board to connect a 100P6Q-A MCU package to a standard pitch universal board. The PCA7754 has a 100P6Q-A IC socket (IC51-1004-809 made by Yamaichi Electronics Co., Ltd.) mounted on its board.

Dimensions

70.0(D)×63.34(W)×17.0(H)mm

(L)=50.8(2.54×20)mm

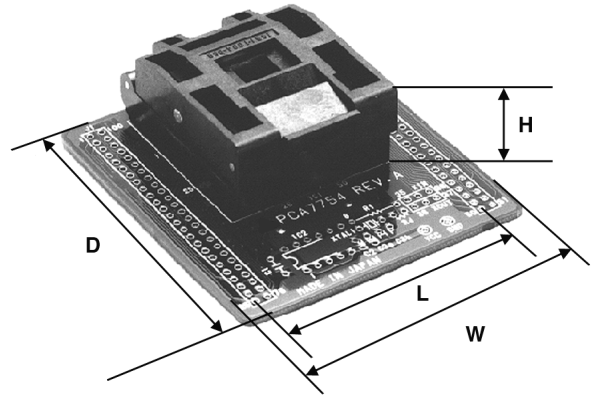

Pin Layout

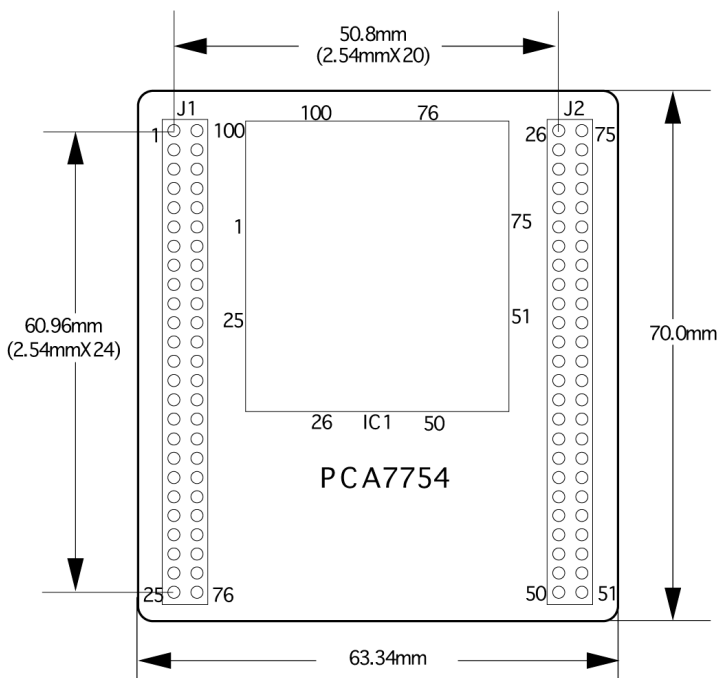

* Pins and other parts needed to connect the standard pitch converter are not included with the product.

[Ordering Information] See Appendix H "Ordering Information".

PCA7755A

Converter from 64-pin 0.8mm-pitch QFP (64P6N-A) to 32-pin DIL Standard Pitch

Function

The PCA7755A is a board that converts a 64-pin 0.8mm-pitch QFP (64P6N-A) to the standard pitch. Pin No. 1 corresponds to pin No. 1.

Application

Use the PCA7755A as a test board to connect a 64P6N-A MCU package to a standard pitch universal board. Since a 64P6N-A IC socket (IC51-824.KS-8095 made by Yamaichi Electronics Co., Ltd.) is mounted on the PCA7755A, it is easy to replace MCUs.

Dimensions

70.0(D)×63.34(W)×20.0(H)mm
(L)=50.8(2.54×20)mm

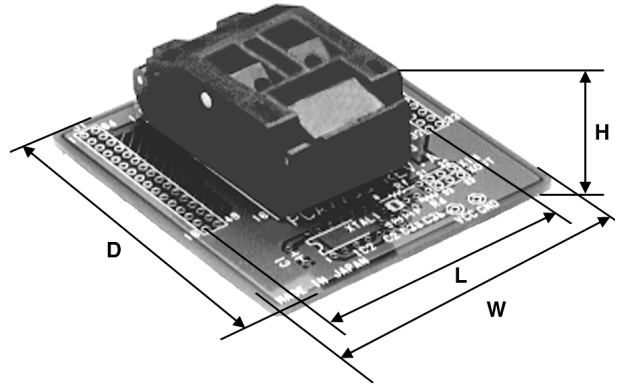

Pin Layout

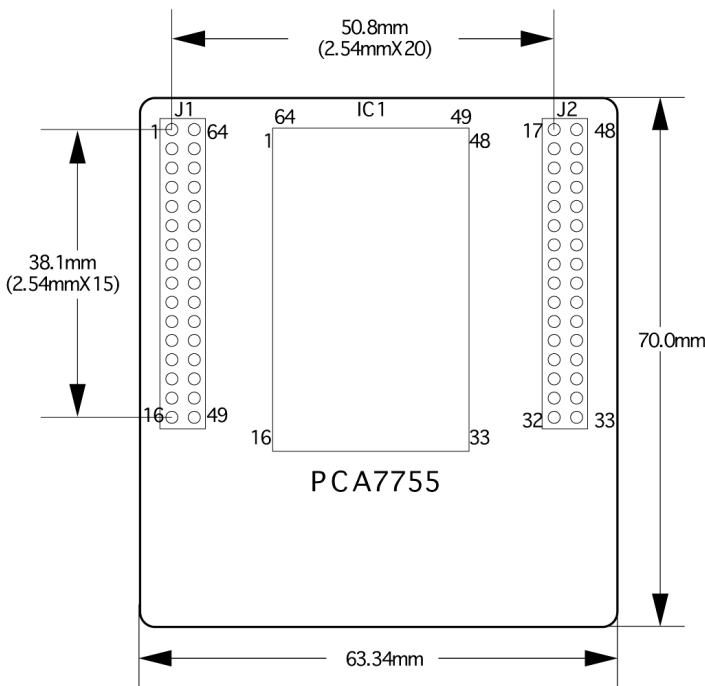

* Pins and other parts needed to connect the standard pitch converter are not included with the product.

[Ordering Information] See Appendix H "Ordering Information".

PCA7755B

Converter from 64-pin 0.8mm-pitch LCC (64D0) to 32-pin DIL Standard Pitch

Function

The PCA7755B is a board that converts a 64-pin 0.8mm-pitch LCC (64D0) to the standard pitch. Pin No. 1 corresponds to pin No. 1.

Application

Use the PCA7755B as a test board to connect a 64D0 MCU package to a standard pitch universal board. Since a 64D0 IC socket (IC51-0644-1329 made by Yamaichi Electronics Co., Ltd.) is mounted on the PCA7755B, it is easy to replace MCUs.

Dimensions

70.0(D)×63.34(W)×20.0(H)mm
(L)=50.8(2.54×20)mm

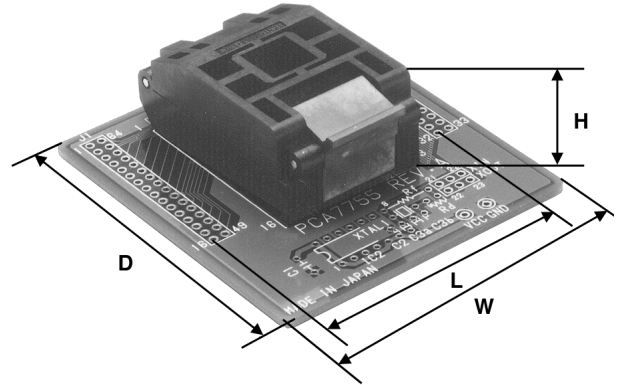

Pin Layout

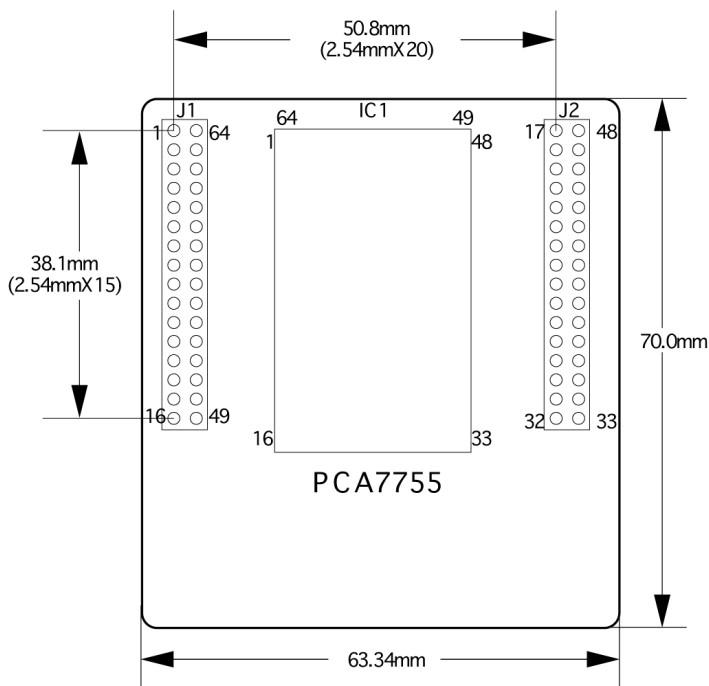

* Pins and other parts needed to connect the standard pitch converter are not included with the product.

[Ordering Information] See Appendix H "Ordering Information".

PCA7756

Converter from 80-pin 0.5mm-pitch QFP (80P6Q-A) to 40-pin DIL Standard Pitch

Function

The PCA7756 is a board that converts an 80-pin 0.5mm-pitch QFP (80P6Q-A to formerly 80P6D-A) to the standard pitch. Pin No. 1 corresponds to pin No. 1.

Application

Use the PCA7756 as a test board to connect an 80P6Q-A MCU package to a standard pitch universal board. Since an 80P6Q-A IC socket (IC51-0804-808 made by Yamaichi Electronics Co., Ltd.) is mounted on the PCA7756, it is easy to replace MCUs.

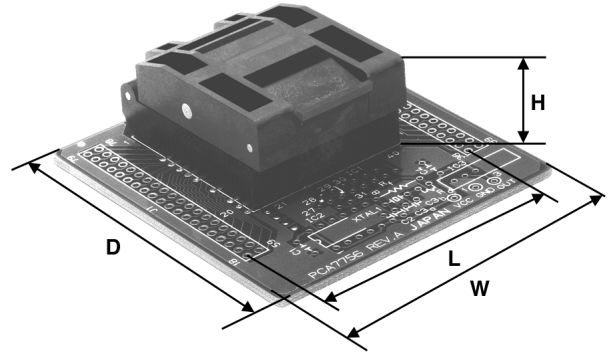

Dimensions

770.0(D)×63.34(W)×20.2(H)mm

(L)=50.8(2.54×20)mm

Pin Layout

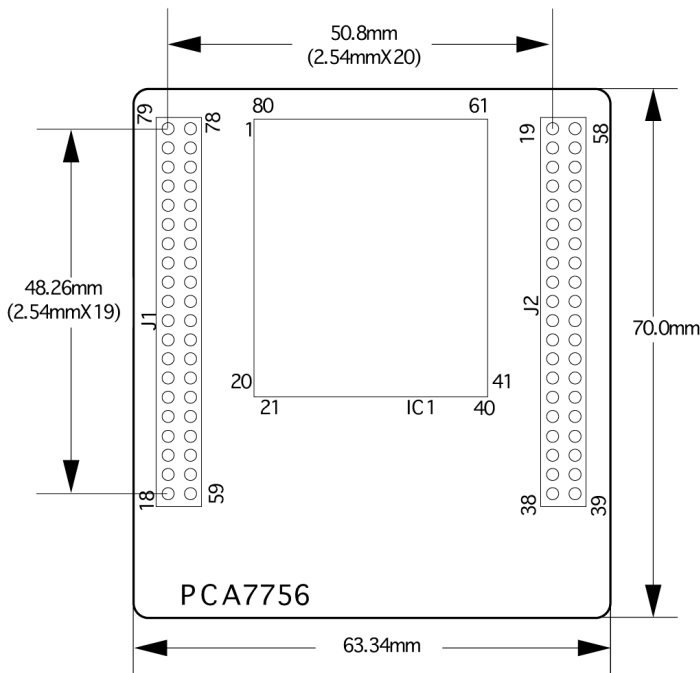

* Pins and other parts needed to connect the standard pitch converter are not included with the product.

[Ordering Information] See Appendix H "Ordering Information".