

EVALUATION KIT  
AVAILABLE



## High-Efficiency, 1.5MHz Op Amps with RRIO

MAX9617/MAX9618

### General Description

The MAX9617/MAX9618 are low-power, zero-drift operational amplifiers, designed for use in portable consumer, medical, and industrial applications.

The MAX9617/MAX9618 feature rail-to-rail CMOS inputs and outputs, a 1.5MHz GBW at just 59µA supply current and 10µV (max) zero-drift input offset voltage over time and temperature. The zero-drift feature of the MAX9617/MAX9618 reduces the high 1/f noise typically found in CMOS input operational amplifiers, making it useful for a wide variety of low-frequency measurement applications.

The MAX9617 is available in a space-saving, 2mm x 2mm, 6-pin SC70 package. The MAX9618 is available in a 2mm x 2mm, 8-pin SC70 package. All devices are specified over the -40°C to +125°C automotive operating temperature range.

### Applications

Sensor Interfaces  
Loop-Powered Systems  
Portable Medical Devices  
Battery-Powered Devices  
Cardiac Monitors

### Features

- ◆ Low 59µA Quiescent Current
- ◆ Very-Low 10µV (max) Input Offset Voltage
- ◆ Low Input Noise  
42nV/√Hz at 1kHz  
1µVp-p from 0.1Hz to 10Hz
- ◆ Rail-to-Rail Inputs and Outputs
- ◆ 1.5MHz GBW
- ◆ Ultra-Low 10pA Input Bias Current
- ◆ Single 1.8V to 5.5V Supply Voltage Range
- ◆ Unity-Gain Stable
- ◆ Available in Tiny 6-Pin SC70 (MAX9617) and 8-Pin SC70 (MAX9618) Packages

### Ordering Information

PART	TEMP RANGE	PIN-PACKAGE
MAX9617AXT+	-40°C to +125°C	6 SC70
MAX9618AXA+*	-40°C to +125°C	8 SC70

+Denotes a lead(Pb)-free/RoHS-compliant package.

\*Future product—contact factory for availability.

### Functional Diagrams

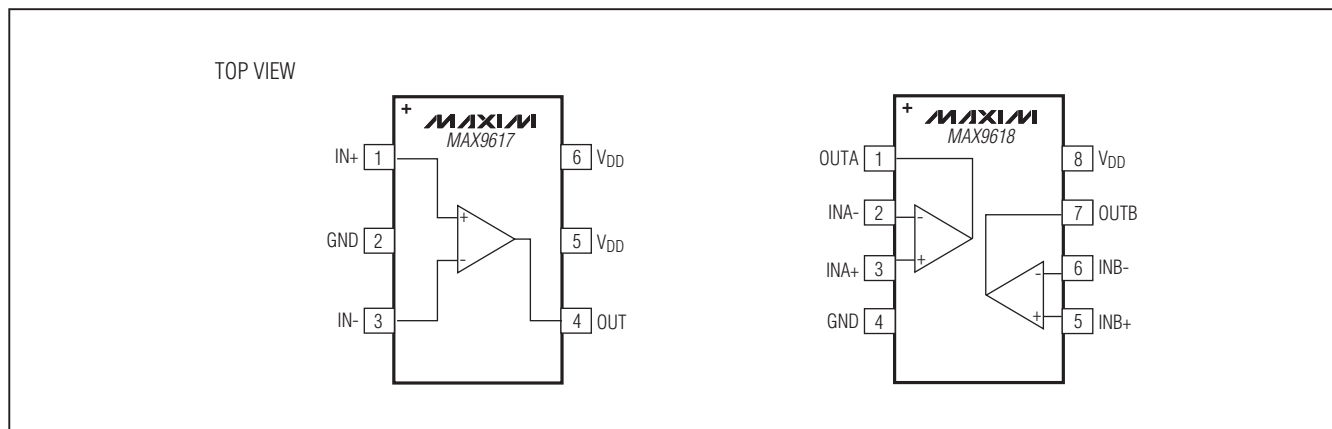

# High-Efficiency, 1.5MHz Op Amps with RRIO

## ABSOLUTE MAXIMUM RATINGS

Supply Voltage (V<sub>DD</sub> to GND).....-0.3V to +6V  
 All Other Pins, IN+ to IN- .....(GND - 0.3V) to (V<sub>DD</sub> + 0.3V)  
 Short-Circuit Duration to Either Supply Rail,  
 OUT, OUTA, OUTB..... 10s  
 Continuous Input Current (any pins)..... ±20mA

Continuous Power Dissipation (T<sub>A</sub> = +70°C)  
 6-Pin SC70 (derate 3.1mW/°C above +70°C).....245.4mW  
 8-Pin SC70 (derate 3.1mW/°C above +70°C).....245mW  
 Operating Temperature Range.....-40°C to +125°C  
 Junction Temperature .....+150°C  
 Storage Temperature Range.....-65°C to +150°C  
 Lead Temperature (soldering, 10s).....+300°C

Stresses beyond those listed under "Absolute Maximum Ratings" may cause permanent damage to the device. These are stress ratings only, and functional operation of the device at these or any other conditions beyond those indicated in the operational sections of the specifications is not implied. Exposure to absolute maximum rating conditions for extended periods may affect device reliability.

## ELECTRICAL CHARACTERISTICS

(V<sub>DD</sub> = +3.3V, V<sub>GND</sub> = 0V, V<sub>IN+</sub> = V<sub>IN-</sub> = V<sub>DD</sub>/2, R<sub>L</sub> = 100kΩ to V<sub>DD</sub>/2, T<sub>A</sub> = -40°C to +125°C, unless otherwise noted. Typical values are at +25°C.) (Note 1)

PARAMETER	SYMBOL	CONDITIONS		MIN	TYP	MAX	UNITS
<b>POWER SUPPLY</b>							
Supply Voltage Range	V <sub>DD</sub>	Guaranteed by PSRR, 0°C ≤ T <sub>A</sub> ≤ +70°C		1.6		5.5	V
		Guaranteed by PSRR, -40°C ≤ T <sub>A</sub> ≤ +125°C		1.8		5.5	
Supply Current (per Amplifier)	I <sub>DD</sub>	T <sub>A</sub> = +25°C			59	78	μA
		-40°C ≤ T <sub>A</sub> ≤ +125°C				111	
Power-Supply Rejection Ratio (Note 2)	PSRR	V <sub>DD</sub> = 1.8V to 5.5V	T <sub>A</sub> = +25°C	119	135		dB
			-40°C ≤ T <sub>A</sub> ≤ +125°C	107			
Power-Up Time	t <sub>ON</sub>	0°C ≤ T <sub>A</sub> ≤ +70°C, V <sub>DD</sub> = 1.6V to 5.5V		116	135		μs
<b>DC SPECIFICATIONS</b>							
Input Offset Voltage (Note 2)	V <sub>OS</sub>	T <sub>A</sub> = +25°C			0.8	10	μV
		-40°C ≤ T <sub>A</sub> ≤ +125°C				25	
Input Offset Voltage Drift (Note 2)	ΔV <sub>OS</sub>				5	120	nV/°C
Input Bias Current (Note 2)	I <sub>B</sub>	T <sub>A</sub> = +25°C			0.01	0.14	nA
		-40°C ≤ T <sub>A</sub> ≤ +125°C				3.5	
Input Offset Current	I <sub>OS</sub>				0.005		
Input Common-Mode Range	V <sub>CM</sub>	Guaranteed by CMRR test	T <sub>A</sub> = +25°C	-0.1		V <sub>DD</sub> + 0.1	V
			-40°C ≤ T <sub>A</sub> ≤ +125°C	-0.1		V <sub>DD</sub> + 0.05	
Common-Mode Rejection Ratio (Note 2)	CMRR	-0.1V ≤ V <sub>CM</sub> ≤ V <sub>DD</sub> + 0.1V, T <sub>A</sub> = +25°C		122	135		dB
		-0.1V ≤ V <sub>CM</sub> ≤ V <sub>DD</sub> + 0.05V, -40°C ≤ T <sub>A</sub> ≤ +125°C		116			
Open-Loop Gain (Note 2)	A <sub>VOL</sub>	20mV ≤ V <sub>OUT</sub> ≤ V <sub>DD</sub> - 20mV, R <sub>L</sub> = 100kΩ to V <sub>DD</sub> /2		120	138		dB
		150mV ≤ V <sub>OUT</sub> ≤ V <sub>DD</sub> - 150mV, R <sub>L</sub> = 5kΩ to V <sub>DD</sub> /2		123	160		

# High-Efficiency, 1.5MHz Op Amps with RRIO

## ELECTRICAL CHARACTERISTICS (continued)

( $V_{DD} = +3.3V$ ,  $V_{GND} = 0V$ ,  $V_{IN+} = V_{IN-} = V_{DD}/2$ ,  $R_L = 100k\Omega$  to  $V_{DD}/2$ ,  $T_A = -40^{\circ}C$  to  $+125^{\circ}C$ , unless otherwise noted. Typical values are at  $+25^{\circ}C$ .) (Note 1)

PARAMETER	SYMBOL	CONDITIONS		MIN	TYP	MAX	UNITS
Input Resistance	$R_{IN}$	Differential			50		$M\Omega$
		Common mode			200		
Output-Voltage Swing	$V_{OH}$	$V_{DD} - V_{OUT}$	$R_L = 100k\Omega$ to $V_{DD}/2$			12	mV
			$R_L = 5k\Omega$ to $V_{DD}/2$			22	
			$R_L = 600\Omega$ to $V_{DD}/2$		50		
	$V_{OL}$	$V_{OUT}$	$R_L = 100k\Omega$ to $V_{DD}/2$			11	
			$R_L = 5k\Omega$ to $V_{DD}/2$			18	
			$R_L = 600\Omega$ to $V_{DD}/2$		50		
Short-Circuit Current	$I_{SC}$				150		mA
<b>AC SPECIFICATIONS</b>							
Gain-Bandwidth Product	GBWP				1.5		MHz
Slew Rate	SR	$0V \leq V_{OUT} \leq 2V$			0.7		V/ $\mu s$
Input Voltage-Noise Density	$e_n$	$f = 1kHz$			42		$nV/\sqrt{Hz}$
Input Voltage Noise		$0.1Hz \leq f \leq 10Hz$			1		$\mu V_{P-P}$
Input Current-Noise Density	$i_n$	$f = 1kHz$			100		$fA/\sqrt{Hz}$
Phase Margin		$C_L = 20pF$			60		Degrees
Capacitive Loading	$C_L$	No sustained oscillation, $A_V = 1V/V$			400		pF
Crosstalk		$f = 10kHz$ (MAX9618)			-100		dB

**Note 1:** Specifications are 100% tested at  $T_A = +25^{\circ}C$  (exceptions noted). All temperature limits are guaranteed by design.

**Note 2:** Guaranteed by design.

## Typical Operating Characteristics

( $V_{DD} = +3.3V$ ,  $V_{GND} = 0V$ , outputs have  $R_L = 100k\Omega$  connected to  $V_{DD}/2$ .  $T_A = +25^{\circ}C$ , unless otherwise specified.)

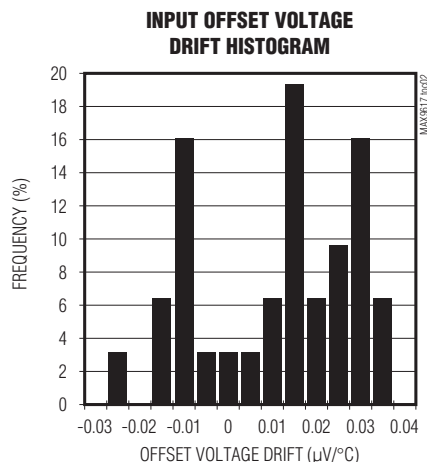
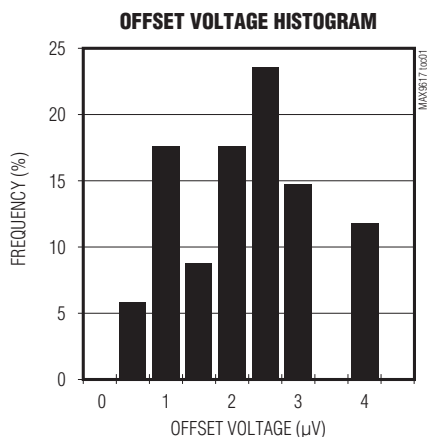

# High-Efficiency, 1.5MHz Op Amps with RRIO

## Typical Operating Characteristics (continued)

( $V_{DD} = +3.3V$ ,  $V_{GND} = 0V$ , outputs have  $R_L = 100k\Omega$  connected to  $V_{DD}/2$ .  $T_A = +25^\circ C$ , unless otherwise specified.)

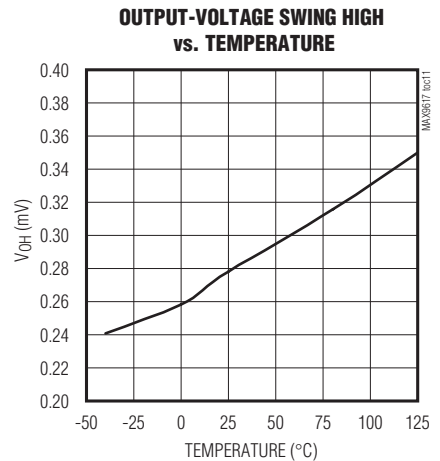
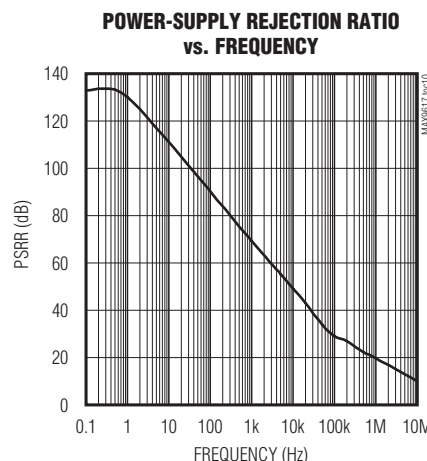
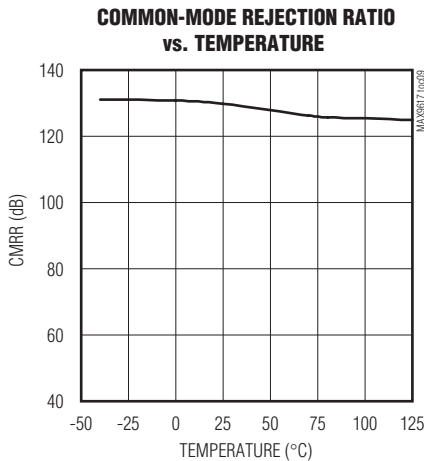
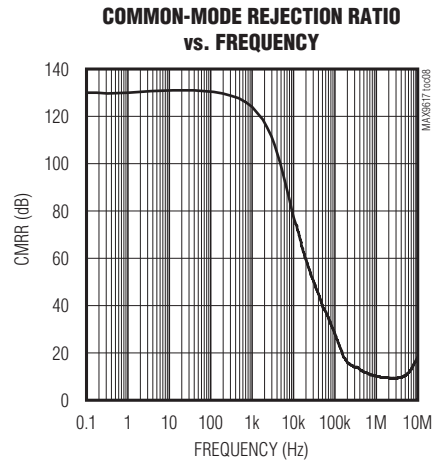
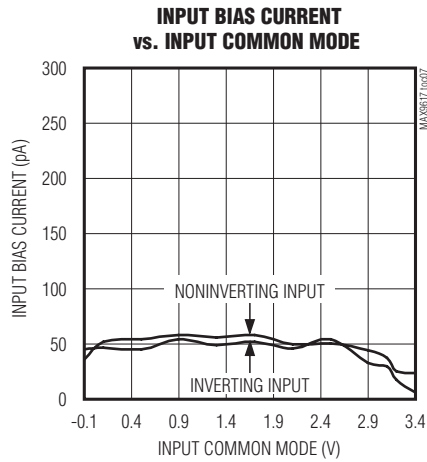
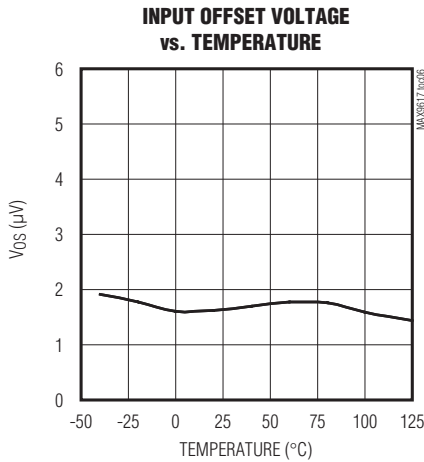
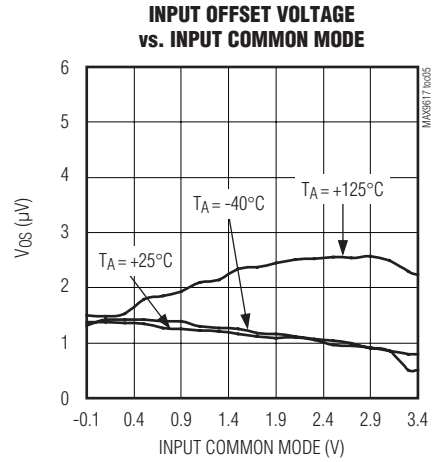
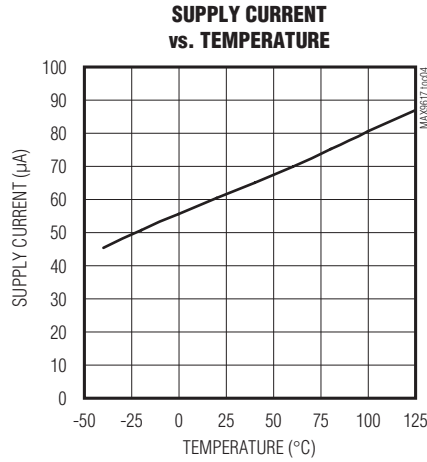
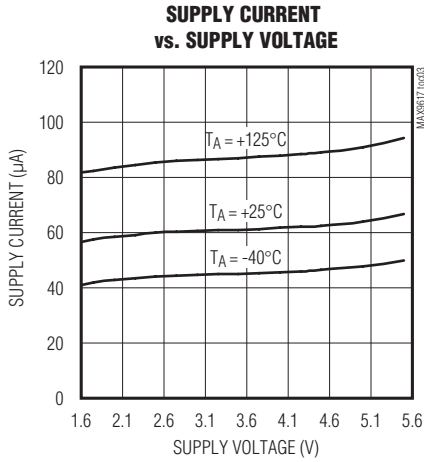

# High-Efficiency, 1.5MHz Op Amps with RRIO

## Typical Operating Characteristics (continued)

( $V_{DD} = +3.3V$ ,  $V_{GND} = 0V$ , outputs have  $R_L = 100k\Omega$  connected to  $V_{DD}/2$ .  $T_A = +25^\circ C$ , unless otherwise specified.)

**OUTPUT-VOLTAGE SWING LOW vs. TEMPERATURE**

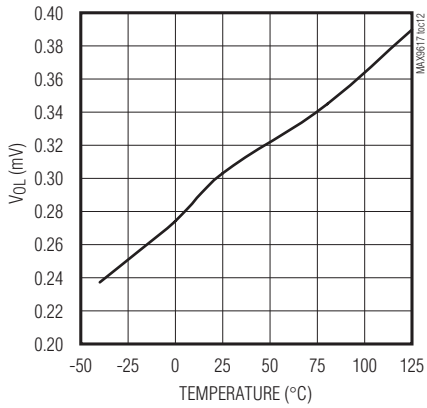

**OPEN-LOOP GAIN vs. FREQUENCY**

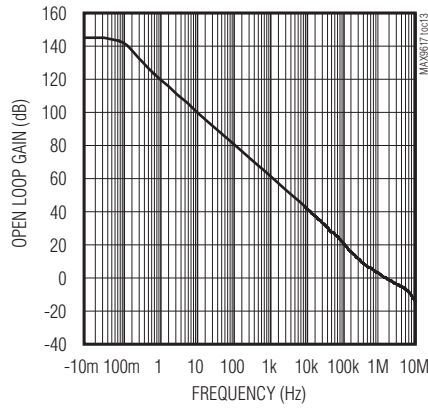

**INPUT VOLTAGE NOISE vs. FREQUENCY**

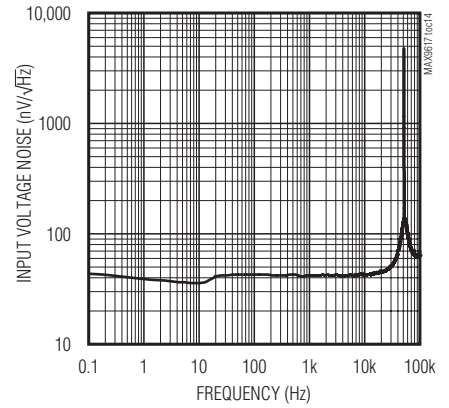

**INPUT VOLTAGE 0.1Hz TO 10Hz NOISE**

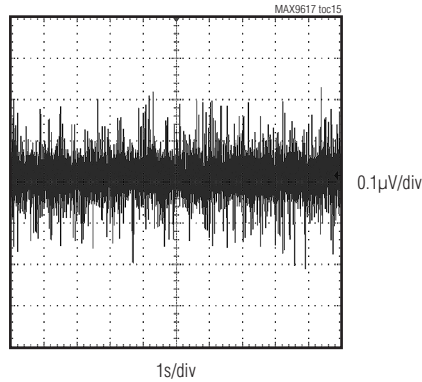

**INPUT CURRENT NOISE vs. FREQUENCY**

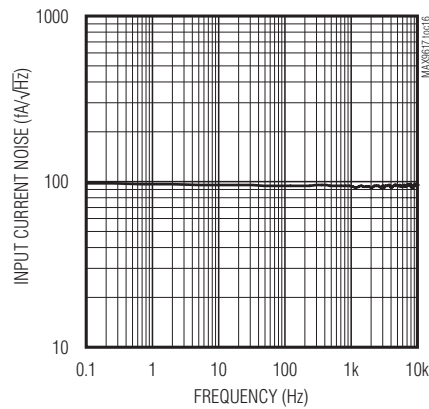

**SMALL-SIGNAL GAIN vs. FREQUENCY**

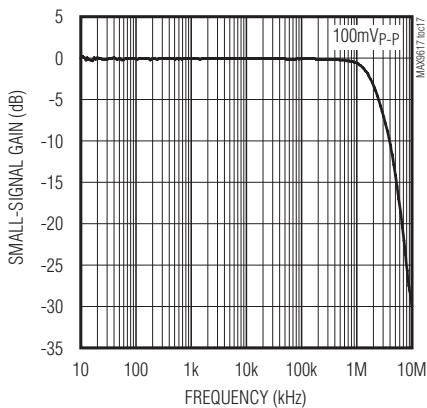

**LARGE-SIGNAL GAIN vs. FREQUENCY**

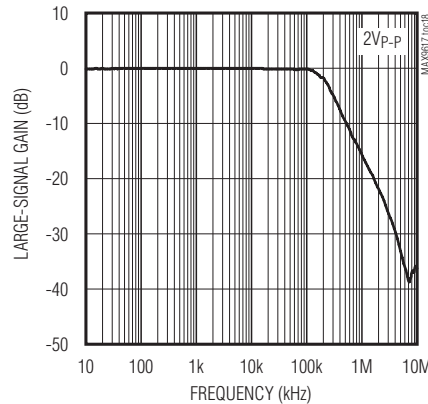

**SMALL-SIGNAL STEP RESPONSE vs. TIME**

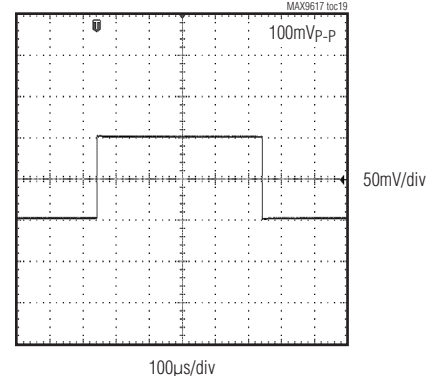

# High-Efficiency, 1.5MHz Op Amps with RRIO

## Typical Operating Characteristics (continued)

( $V_{DD} = +3.3V$ ,  $V_{GND} = 0V$ , outputs have  $R_L = 100k\Omega$  connected to  $V_{DD}/2$ .  $T_A = +25^\circ C$ , unless otherwise specified.)

**LARGE-SIGNAL STEP RESPONSE vs. TIME**

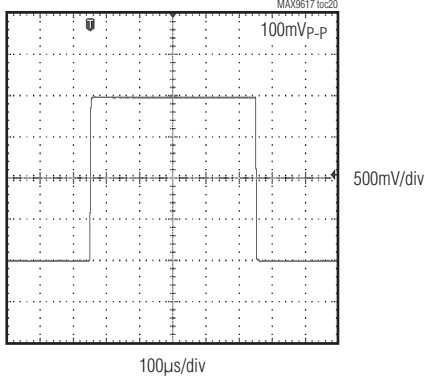

**CAPACITIVE LOAD vs. ISOLATION RESISTOR**

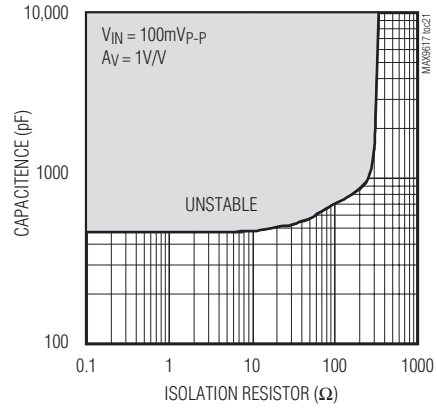

## Pin Configurations

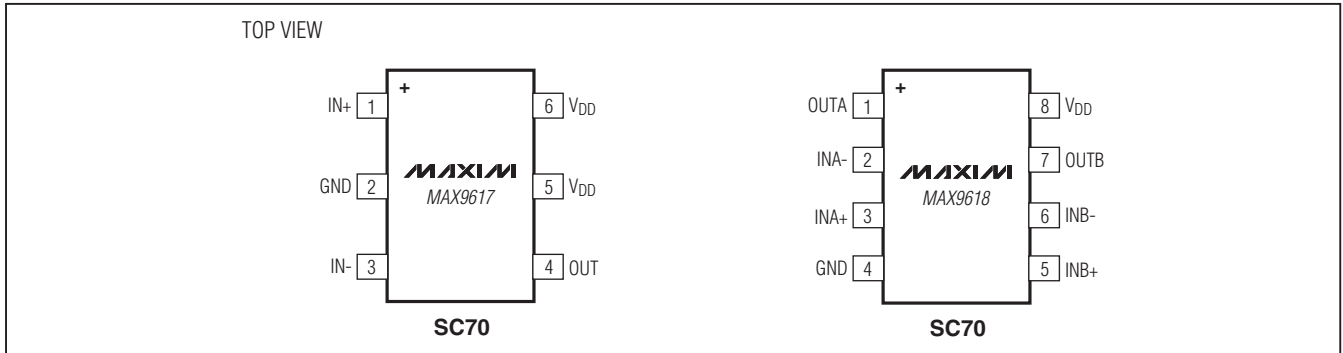

## Pin Description

PIN		NAME	FUNCTION
MAX9617	MAX9618		
1	—	IN+	Positive Input
2	4	GND	Ground
3	—	IN-	Negative Input
4	—	OUT	Output
5, 6	8	$V_{DD}$	Positive Supply Voltage. Bypass to GND with a 0.1µF capacitor.
—	1	OUTA	Channel A Output
—	2	INA-	Channel A Negative Input
—	3	INA+	Channel A Positive Input
—	5	INB+	Channel B Positive Input
—	6	INB-	Channel B Negative Input
—	7	OUTB	Channel B Output

## High-Efficiency, 1.5MHz Op Amps with RRIO

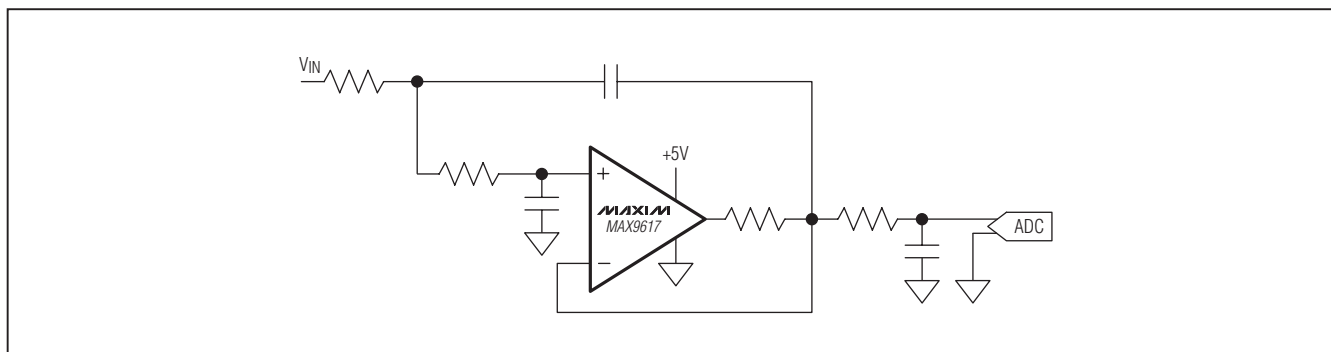

Figure 1. Typical Application Circuit: Sallen-Key Active Lowpass Filter

### Detailed Description

The MAX9617 (single) and MAX9618 (dual) are precision, low-power op amps ideal for signal processing applications. These devices use an innovative autozero technique that allows precision and low noise with a minimum amount of power. The low input offset voltage, CMOS inputs, and the absence of  $1/f$  noise allows for optimization of active filter designs.

The MAX9617/MAX9618 achieve rail-to-rail performance at the input through the use of a low-noise charge pump. This ensures a glitch-free, common-mode input voltage range extending from the negative supply rail up to the positive supply rail, eliminating crossover distortion common to traditional n-channel/p-channel CMOS pair inputs, reducing harmonic distortion at the output.

#### Autozero

The MAX9617/MAX9618 feature an autozero circuit that allows the device to achieve less than  $10\mu\text{V}$  (max) of input offset voltage and eliminates the  $1/f$  noise.

#### Internal Charge Pump

An internal charge pump provides an internal supply typically 1V beyond the upper rail. This internal rail allows the MAX9617/MAX9618 to achieve true rail-to-rail inputs and outputs, while providing excellent common-mode rejection, power-supply rejection ratios, and gain linearity.

The charge pump requires no external components, and in most applications is entirely transparent to the user. The operating frequency is well beyond the unity-gain frequency of the amplifier, avoiding aliasing or other signal integrity issues in sensitive applications.

### Applications Information

The MAX9617/MAX9618 low-power, low-noise, and precision operational amplifiers are designed for applications in the portable medical, such as ECG and pulse oximetry, portable consumer, and industrial markets.

The MAX9617/MAX9618 are also ideal for loop-powered systems that interface with pressure sensors or strain gauges.

#### Capacitive-Load Stability

Driving large capacitive loads can cause instability in many op amps. The MAX9617/MAX9618 are stable with capacitive loads up to  $400\text{pF}$ . Stability with higher capacitive loads can be improved by adding an isolation resistor in series with the op-amp output. This resistor improves the circuit's phase margin by isolating the load capacitor from the amplifier's output. The graph in the *Typical Operating Characteristics* gives the stable operation region for capacitive load versus isolation resistors.

#### Power Supplies and Layout

The MAX9617/MAX9618 operate either with a single supply from  $+1.6\text{V}$  to  $+5.5\text{V}$  with respect to ground or with dual supplies from  $\pm 0.8\text{V}$  to  $\pm 2.75\text{V}$ . When used with dual supplies, bypass both supplies with their own  $0.1\mu\text{F}$  capacitor to ground. When used with a single supply, bypass  $V_{\text{DD}}$  with a  $0.1\mu\text{F}$  capacitor to ground.

Careful layout technique helps optimize performance by decreasing the amount of stray capacitance at the op amp's inputs and outputs. To decrease stray capacitance, minimize trace lengths by placing external components close to the op amp's pins.

### Chip Information

PROCESS: BiCMOS

# High-Efficiency, 1.5MHz Op Amps with RRIO

## Package Information

For the latest package outline information and land patterns, go to [www.maxim-ic.com/packages](http://www.maxim-ic.com/packages).

PACKAGE TYPE	PACKAGE CODE	DOCUMENT NO.
6 SC70	X6SN-1	<a href="#">21-0077</a>
8 SC70	X8C+1	<a href="#">21-0460</a>

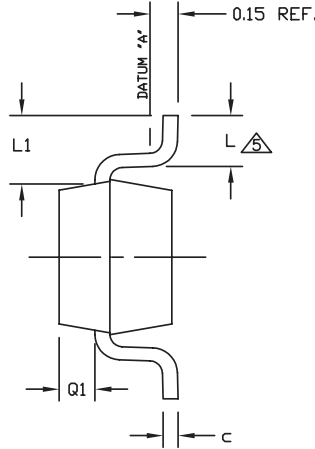
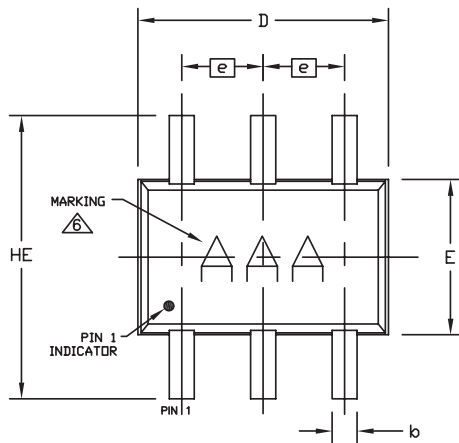

COMMON DIMENSIONS			
SYMBOL	MIN	NDM	MAX
A	0.80	0.95	1.10
A1	0.00	0.07	0.10
A2	0.80	0.90	1.00
b	0.15	0.22	0.30
c	0.10	0.14	0.18
D	1.80	2.00	2.20
e	0.65 BSC.		
E	1.15	1.25	1.35
HE	1.80	2.20	2.40
L	0.26	0.34	0.46
L1	0.425 TYP.		
Q1	0.10	0.25	0.40
PKG CODES	X6SN-1		

- NOTES:
1. ALL DIMENSIONS ARE IN MILLIMETERS.
  2. DIMENSIONS ARE INCLUSIVE OF PLATING.
  3. DIMENSIONS ARE EXCLUSIVE OF MOLD FLASH & METAL BURR.
  4. COPLANARITY 4 MILS. MAX.
  5. FOOT LENGTH MEASURED AT INTERCEPT POINT BETWEEN DATUM "A" AND LEAD SURFACE.
  6. MARKING IS FOR PACKAGE ORIENTATION REFERENCE ONLY.
  7. LEAD CENTERLINES TO BE AT TRUE POSITION AS DEFINED BY BASIC DIMENSION "e", ±0.05.
  8. ALL DIMENSIONS COMPLY TO JEDEC MO-203.
  9. ALL DIMENSIONS APPLY TO BOTH LEADED (-) AND LEAD FREE (+) PACKAGE CODES.

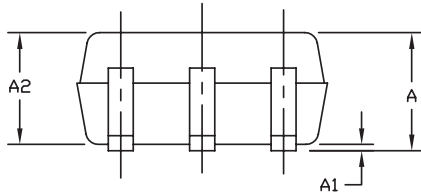

-DRAWING NOT TO SCALE-

**MAXIM**

TITLE: PACKAGE OUTLINE, 6L SC70		
APPROVAL	DOCUMENT CONTROL NO. 21-0077	REV. G 1/1

SC70, 6L EPS



# High-Efficiency, 1.5MHz Op Amps with RRIO

## Package Information (continued)

For the latest package outline information and land patterns, go to [www.maxim-ic.com/packages](http://www.maxim-ic.com/packages).

MAX9617/MAX9618

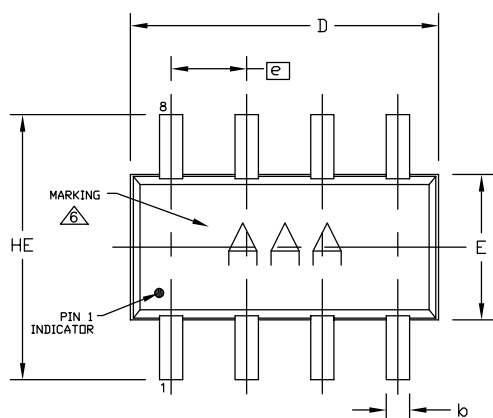

TOP VIEW

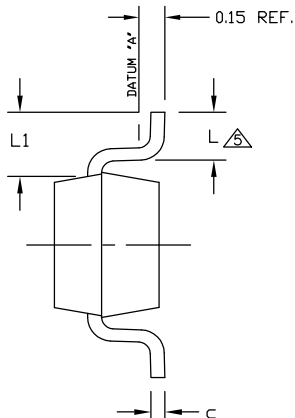

SIDE VIEW

COMMON DIMENSIONS			
SYMBOL	MIN	NOM	MAX
A	0.80	0.95	1.10
A1	0.00	0.07	0.10
A2	0.80	0.90	1.00
A3	0.40	0.47	0.55
b	0.15	0.21	0.27
c	0.10	0.14	0.18
D	1.80	2.00	2.20
e	0.50 BSC.		
E	1.15	1.25	1.35
HE	1.80	2.20	2.40
L	0.26	0.34	0.46
L1	0.425 TYP.		
PKG. CODE	X8C-1		

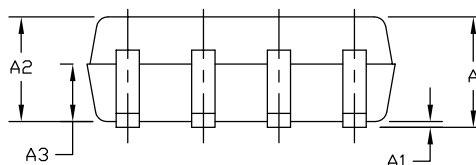

SIDE VIEW

NOTES:

1. ALL DIMENSIONS ARE IN MILLIMETERS.
2. DIMENSIONS ARE INCLUSIVE OF PLATING.
3. DIMENSIONS ARE EXCLUSIVE OF MOLD FLASH & METAL BURR.
4. COPLANARITY 4 MILS. MAX.
5. FOOT LENGTH MEASURED AT INTERCEPT POINT BETWEEN DATUM "A" AND LEAD SURFACE.
6. MARKING IS FOR PACKAGE ORIENTATION REFERENCE ONLY.
7. LEAD CENTERLINES TO BE AT TRUE POSITION AS DEFINED BY BASIC DIMENSION "e", ±0.05.
8. ALL DIMENSIONS COMPLY TO JEDEC MO-203.
9. ALL DIMENSIONS APPLY TO BOTH LEADED (-) AND LEAD FREE (+) PACKAGE CODES.

-DRAWING NOT TO SCALE-

<b>MAXIM</b>		
TITLE: PACKAGE OUTLINE, 8L SC70, COL PKG.		
APPROVAL	DOCUMENT CONTROL NO. 21-0460	REV. A 1/1

# **High-Efficiency, 1.5MHz Op Amps with RRIO**

## **Revision History**

<b>REVISION NUMBER</b>	<b>REVISION DATE</b>	<b>DESCRIPTION</b>	<b>PAGES CHANGED</b>
0	7/09	Initial release	—
1	9/09	Removed references to MAX9617 shutdown functionality	1, 2, 3, 6, 7

*Maxim cannot assume responsibility for use of any circuitry other than circuitry entirely embodied in a Maxim product. No circuit patent licenses are implied. Maxim reserves the right to change the circuitry and specifications without notice at any time.*

**10** \_\_\_\_\_ **Maxim Integrated Products, 120 San Gabriel Drive, Sunnyvale, CA 94086 408-737-7600**