

# SF161CTD THRU SF168CTD

**GLASS PASSIVATED SUPER FAST RECTIFIER**  
**Reverse Voltage – 50 to 800 V**  
**Forward Current – 16 A**

## Features

- Low forward voltage drop
- Low reverse leakage current
- Superfast switching time for high efficiency
- High current capability
- High surge current capability

## Mechanical Data

- Case: Molded plastic, TO-220
- Epoxy: UL 94V-0 rate flame retardant
- Terminals: leads solderable per MIL-STD-202 method 208 guaranteed
- Polarity: As marked
- Mounting Position: Any

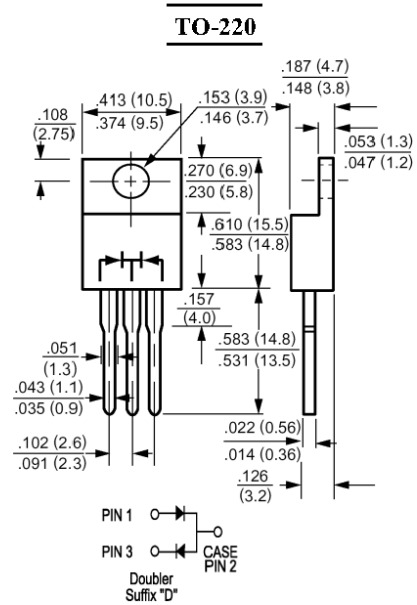

**Dimensions in inches and (millimeters)**

## Absolute Maximum Ratings and Characteristics

Ratings at 25 °C ambient temperature unless otherwise specified. Single phase, half wave, 60 Hz, resistive or inductive load. For capacitive load, derate current by 20%.

Parameter	Symbols	SF161CTD	SF162CTD	SF163CTD	SF164CTD	SF165CTD	SF166CTD	SF167CTD	SF168CTD	Units	
Maximum Recurrent Peak Reverse Voltage	$V_{RRM}$	50	100	150	200	300	400	500	600	V	
Maximum RMS Voltage	$V_{RMS}$	35	70	105	140	210	280	350	420	V	
Maximum DC Blocking Voltage	$V_{DC}$	50	100	150	200	300	400	500	600	V	
Maximum Average Forward Rectified Current at $T_C = 100^\circ\text{C}$	$I_{(AV)}$	16								A	
Peak Forward Surge Current, 8.3 ms Single half Sine-wave Superimposed on Rated Load (JEDEC method)	$I_{FSM}$	125								A	
Maximum Forward Voltage at 8 A and 25 °C	$V_F$	0.95			1.3		1.7			V	
Maximum Reverse Current at $T_A = 25^\circ\text{C}$ at Rated DC Blocking Voltage $T_A = 100^\circ\text{C}$	$I_R$	10 500								$\mu\text{A}$	
Typical Junction Capacitance <sup>1)</sup>	$C_J$	80			60						pF
Maximum Reverse Recovery Time <sup>2)</sup>	$t_{rr}$	35			50						ns
Typical Thermal Resistance <sup>3)</sup>	$R_{\theta JC}$	2.5								$^\circ\text{C}/\text{W}$	
Operating and Storage Temperature Range	$T_J, T_S$	-55 to +150								$^\circ\text{C}$	

<sup>1)</sup> Measured at 1 MHz and applied reverse voltage of 4 VDC.

<sup>2)</sup> Reverse recovery test conditions:  $I_F = 0.5 \text{ A}$ ,  $I_R = 1 \text{ A}$ ,  $I_{RR} = 0.25 \text{ A}$

<sup>3)</sup> Thermal resistance from Junction to case per leg mounted on heatsink.

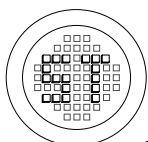

**SEMTECH ELECTRONICS LTD.**

(Subsidiary of Semtech International Holdings Limited, a company listed on the Hong Kong Stock Exchange, Stock Code: 724)

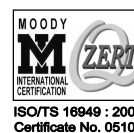

# SF161CTD THRU SF168CTD

FIG.1- REVERSE RECOVERY TIME CHARACTERISTIC AND TEST CIRCUIT DIAGRAM

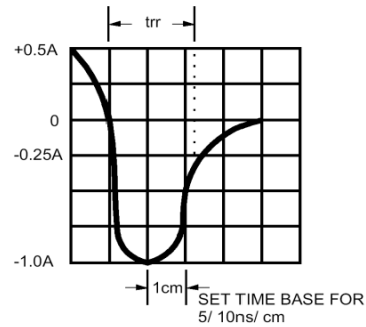
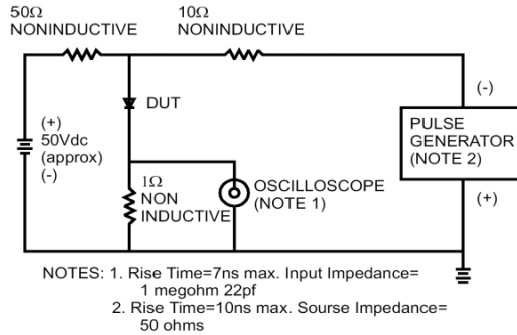

FIG.2- MAXIMUM FORWARD CURRENT DERATING CURVE

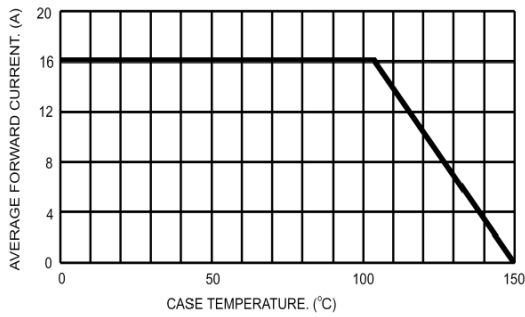

FIG.3- TYPICAL REVERSE CHARACTERISTICS

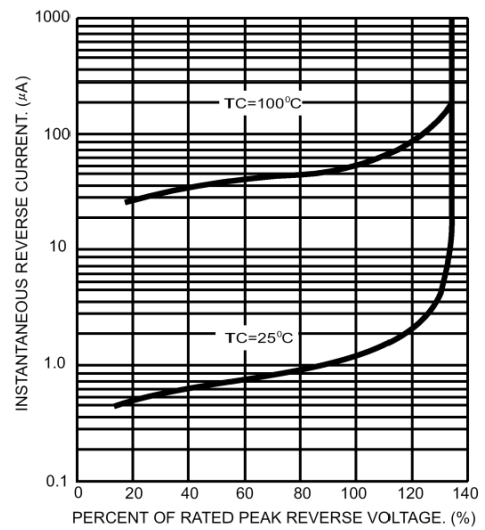

FIG.4- MAXIMUM NON-REPETITIVE FORWARD SURGE CURRENT PER LEG

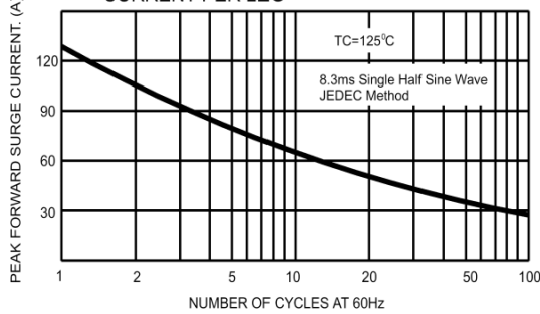

FIG.6- TYPICAL FORWARD CHARACTERISTICS PER LEG

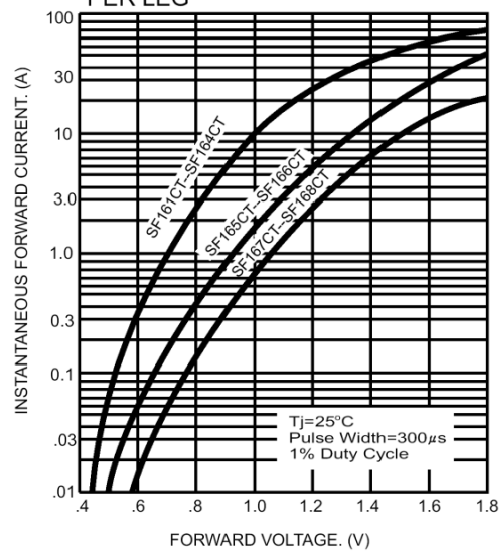
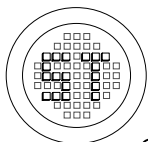
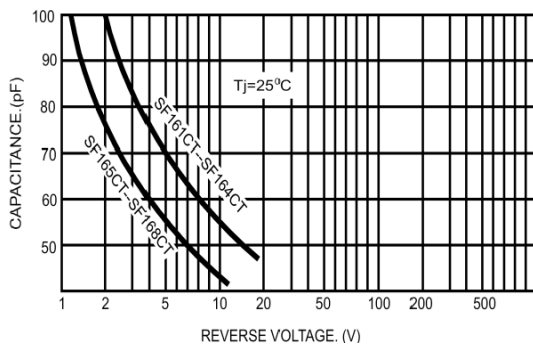

FIG.5- TYPICAL JUNCTION CAPACITANCE PER LEG



**SEMTECH ELECTRONICS LTD.**  
(Subsidiary of Semtech International Holdings Limited, a company listed on the Hong Kong Stock Exchange, Stock Code: 724)

