

FEATURES

- Output Current up to 5.5A
- High Efficiency up to 89%
- Fixed Switching Frequency
- Six-Sided Continuous Shielding
- 20 Watts Maximum Output Power
- 4:1 Ultra Wide Input Voltage Range
- Standard 2.0 x 1.0 x 0.4 Inch Package
- **Options: Negative Logic Remote ON/OFF**
- Compliant to RoHS EU Directive 2002/95/EC
- CE Mark Meets 2006/95/EC, 93/68/EEC, and 89/336 EEC

APPLICATIONS

- Measurement
- Wireless Network
- Telecom/Datacom
- Industry Control System
- Semiconductor Equipment



SPECIFICATIONS: MDW Ultra Wide Series

All specifications apply @ 25°C ambient unless otherwise noted

INPUT SPECIFICATIONS

Input Voltage Range	24V nominal input	9-36VDC
	48V nominal input	18-75VDC
Input Filter		Pi Type
Input Voltage Variation	dv/dt	5V/ms max (Complies with ETS300 132 part 4.4)
Input Surge Voltage (100ms max)	24V input	50VDC
	48V input	100VDC
Input Reflected Ripple Current (nominal Vin and full load)		20mA _{p-p}
Start Up Time (nominal Vin and constant resistive load)		
Power Up		20ms typ.
Remote ON/OFF		20ms typ.
Start Up Voltage	24V input	9 VDC
	48V input	18 VDC
Shutdown Voltage	24V input	7.5 VDC
	48V input	15 VDC
Remote ON/OFF (Note 6)		
(Positive Logic)	DC-DC ON	Open or 3V < Vr < 12V
	DC-DC OFF	Short or 0V < Vr < 1.2V
(Negative Logic)	DC-DC ON	Short or 0V < Vr < 1.2V
	DC-DC OFF	Open or 3V < Vr < 12V
Input Current of Remote Control Pin (nominal Vin)		-0.5mA ~ +0.5mA
Remote Off Input Current (nominal Vin)		2.5mA

OUTPUT SPECIFICATIONS

Output Voltage		see table
Voltage Accuracy (nominal Vin and full load)		±1%
Voltage Adjustability		10%
Output Current		see table
Output Power		20 watts max.
Line Regulation (LL to HL at FL)	Single	±0.2%
	Dual	±0.5%
Load Regulation (no load to full load)	Single	±0.5%
	Dual	±1%
Cross Regulation (Dual) (Asymmetrical load 25% / 100% FL)		±5%
Minimum Load		0%
Ripple/Noise (20 MHz BW)		see table (measured with a 0.1uF/50V MLCC)
Temperature Coefficient		±0.02% / °C max.
Transient Response Recovery Time (25% load step)		250us

PROTECTION SPECIFICATIONS

Over Voltage Protection	3.3V output	3.9V
(zener diode clamp)	5V output	6.2V
	12V output	15V
	15V output	18V
Over Load Protection (% of full load at nominal input)		150% typ.
Short Circuit Protection		Hiccup, automatic recovery

GENERAL SPECIFICATIONS

Efficiency		see table
Switching Frequency		400KHz typ.
Isolation Voltage (Input to Output)		1600VDC min.
Isolation Voltage (Input to case)		1600VDC min.
Isolation Voltage (Output to Case)		1600VDC min.
Isolation Resistance		10 ⁹ ohms min.
Isolation Capacitance		1500pF max.
Case Grounding		Connect case to -Vin with decoupling Y Cap

ENVIRONMENTAL SPECIFICATIONS

Operating Temperature		-40°C ~ +66°C (w/o derating)
		+66°C ~ +105°C (w derating)
Storage Temperature		-55°C ~ +125°C
Maximum Case Temperature		105°C
Relative Humidity		5% to 95% RH
Thermal Impedance (Note 7)		
Natural Convection		12°C / Watt
Natural Convection with Heat-Sink		10°C / Watt
Thermal Shock		MIL-STD-810F
Vibration		10~55Hz, 10G, 30 minutes along X, Y, and Z
MTBF (Note 1)	BELLCORE TR-NWT-000332	1.691 X 10 ⁶ hrs
	MIL-STD-217F	5.629 x 10 ⁵ hrs

PHYSICAL SPECIFICATIONS

Weight		27g (0.95 oz)
Dimensions		2.0 x 1.0 x 0.40 inches (50.8 x 25.4 x 10.2 mm)
Case Material		Nickel-coated copper
Base Material		FR4 PCB (Effective July 2008)
Potting material		Epoxy (UL94-V0)
Shielding		six-sided

Due to advances in technology, specifications subject to change without notice

SAFETY & EMC

Safety Standard Pending IEC60950-1, UL60950-1, EN60950-1
EMI (See Note 8) EN55022 Class A
ESD EN61000-4-2 Air $\pm 8KV$ Perf. Criteria B
Contact $\pm 6KV$ Perf. Criteria B

Radiated Immunity EN61000-4-3 10V/m Perf. Criteria A
Fast Transient EN61000-4-4 $\pm 2KV$ Perf. Criteria B
Surge (See Note 9) EN61000-4-5 $\pm 1KV$ Perf. Criteria B
Conducted Immunity EN61000-4-6 10 Vrms Perf. Criteria A

OUTPUT VOLTAGE / CURRENT RATING CHART

Model Number	Input Range	Output Voltage	Output Current		Output ⁽⁴⁾ Ripple & Noise	Input Current		Efficiency ⁽⁴⁾	Capacitor ⁽⁵⁾ Load max
			Min. load	Full load		No load ⁽³⁾	Full load ⁽²⁾		
MDW24S3.3-5500	24 VDC (9-36 VDC)	3.3 VDC	0mA	5500mA	60mVp-p	50mA	934mA	85%	18000uF
MDW24S5-4000		5 VDC	0mA	4000mA	75mVp-p	65mA	992mA	88%	9600uF
MDW24S12-1670		12 VDC	0mA	1670mA	75mVp-p	22mA	1018mA	86%	1650uF
MDW24S15-1330		15 VDC	0mA	1330mA	75mVp-p	22mA	1014mA	86%	1050uF
MDW24D5-2000		± 5 VDC	0mA	± 2000 mA	100mVp-p	55mA	992mA	88%	± 4800 uF
MDW24D12-833		± 12 VDC	0mA	± 833 mA	100mVp-p	30mA	1004mA	87%	± 825 uF
MDW24D15-667		± 15 VDC	0mA	± 667 mA	100mVp-p	30mA	1005mA	87%	± 525 uF
MDW48S3.3-5500	48 VDC (18-75 VDC)	3.3 VDC	0mA	5500mA	60mVp-p	35mA	467mA	85%	18000uF
MDW48S5-4000		5 VDC	0mA	4000mA	75mVp-p	35mA	496mA	88%	9600uF
MDW48S12-1670		12 VDC	0mA	1670mA	75mVp-p	15mA	503mA	87%	1650uF
MDW48S15-1330		15 VDC	0mA	1330mA	75mVp-p	15mA	501mA	87%	1050uF
MDW48D5-2000		± 5 VDC	0mA	± 2000 mA	100mVp-p	35mA	490mA	89%	± 4800 uF
MDW48D12-833		± 12 VDC	0mA	± 833 mA	100mVp-p	17mA	496mA	88%	± 825 uF
MDW48D15-667		± 15 VDC	0mA	± 667 mA	100mVp-p	17mA	496mA	88%	± 525 uF

NOTES

- BELLCORE TR-NWT-000332. Case 1: 50% Stress, Temperature at 40°C (Ground fixed and controlled environment). MIL-STD-217F Notice2 @Ta=25 °C, Full load (Ground, Benign, controlled environment)
- Maximum value at nominal input voltage and full load.
- Typical value at nominal input voltage and no load.
- Typical value at nominal input voltage and full load.
- Test by minimum Vin and constant resistive load.
- The ON/OFF control pin voltage is referenced to -Vin. To order negative logic ON/OFF control add the suffix "R" (Ex: MDW48S5-4000R)
- Heat sink is optional, consult factory for ordering details.
- The MDW Series can meet EN55022 Class A with an external capacitor in parallel with the input pins. Recommended: 24Vin: NA. 48Vin: 1µF/100V
- An external filter capacitor is required if the module has to meet EN61000-4-5. The filter capacitor Wall Industries suggests: Nippon chemi-con KY Series, 220uF/100V, ESR 48mΩ.

DERATING CURVES & EFFICIENCY GRAPHS

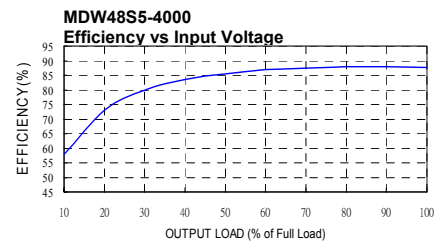
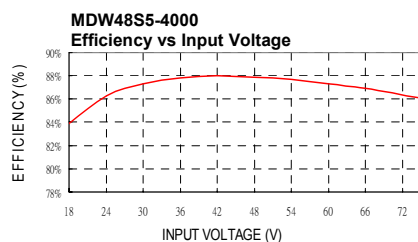
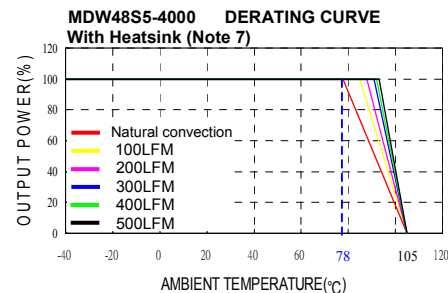
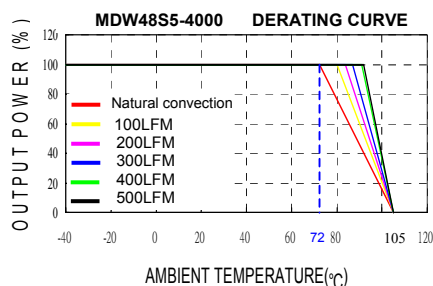

MECHANICAL DRAWING

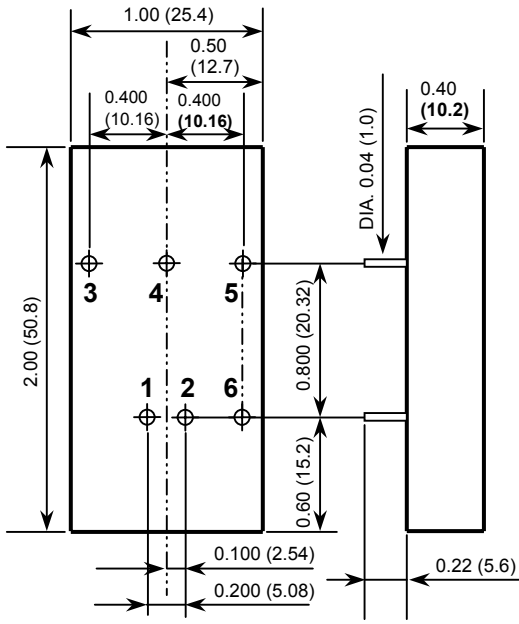

- All dimensions in Inches (mm)
Tolerance: X.XX±0.02 (X.X±0.5)
X.XXX±0.01 (X.XX±0.25)
- Pin pitch tolerance ±0.01(0.25)

PIN CONNECTION		
PIN	SINGLE	DUAL
1	+INPUT	+INPUT
2	-INPUT	-INPUT
3	+OUTPUT	+OUTPUT
4	TRIM	COMMON
5	-OUTPUT	-OUTPUT
6	CTRL	CTRL

EXTERNAL OUTPUT TRIMMING

Output can be externally trimmed by using the method shown below.

TRIM UP

TRIM DOWN

FIGURE 1

Recommended Filter for EN55022 Class B Compliance

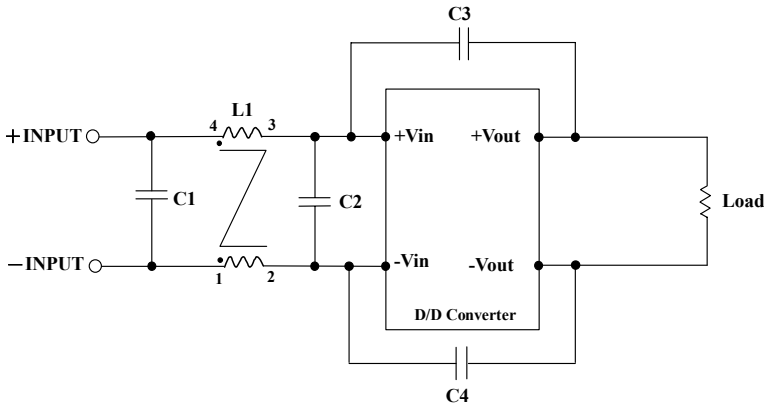
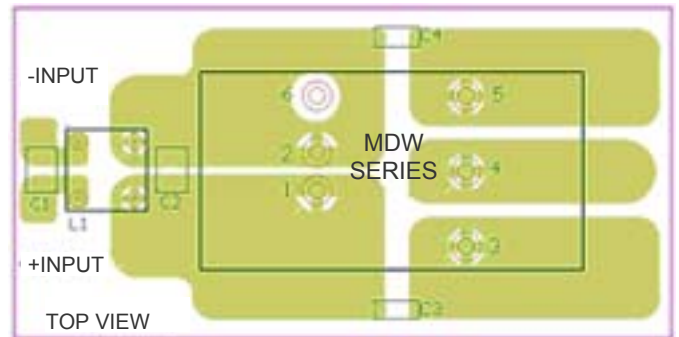

FIGURE 2

Recommended EN55022 Class B Filter Circuit Layout



The components used in the Figure 1, together with the manufacturers' part numbers for these components, are as follows:

	C1	C2	C3	C4	L1
MDW24xxx-xxxx	4.7uF/50V	N/A	1000pF/2KV	1000pF/2KV	450uH Common Choke
MDW48xxx-xxxx	2.2uF/100V	2.2uF/100V	1000pF/2KV	1000pF/2KV	325uH Common Choke