



# 700mA DC-DC Step-Down Converters with Dual 300mA LDO in 2mm x 2mm CSP

## General Description

The MAX8884Y/MAX8884Z step-down converters with dual low-dropout (LDO) linear regulators are intended to power low-voltage microprocessors, DSPs, camera and Wi-Fi modules, or other point of load applications in portable devices. These ICs feature high efficiency with small external component size. The step-down converter output voltage is pin selectable between 1.2V and 1.8V, and provides guaranteed output current of 700mA. The 2/4MHz hysteretic-PWM control scheme allows for tiny external components and reduces no-load operating current to 50 $\mu$ A. Two low quiescent current, low-noise LDOs operate down to 2.7V supply voltage. Two switching frequency options are available—MAX8884Y (2MHz) and MAX8884Z (4MHz)—allowing optimization for smallest solution size or highest efficiency. Fast switching allows the use of small ceramic 2.2 $\mu$ F input and output capacitors while maintaining low ripple voltage. The MAX8884Y/MAX8884Z have individual enables for each output, maximizing flexibility.

The MAX8884Y/MAX8884Z are available in a 16-bump, 2mm x 2mm CSP package (0.7mm max height).

## Applications

Cell Phones/Smartphones  
PDA and Palmtop Computers  
Portable MP3 and DVD Players  
Digital Cameras, Camcorders  
PCMCIA Cards  
Handheld Instruments

## Typical Operating Circuit

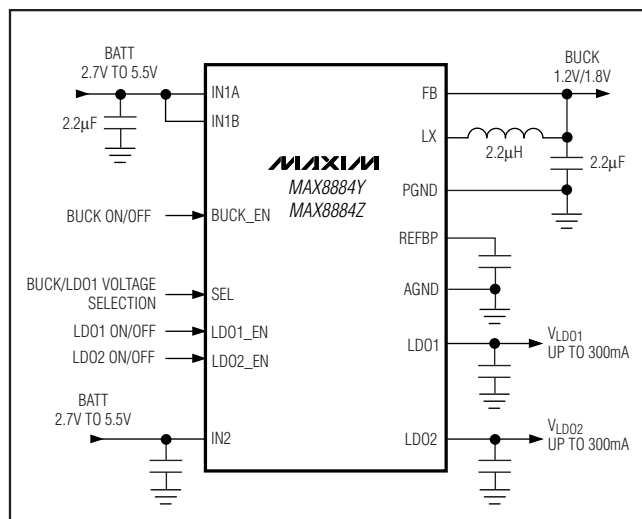

## Features

- ◆ Step-Down Converter
  - Pin-Selectable Output Voltage (1.2V/1.8V)
  - 2MHz or 4MHz Switching Frequency
  - Low-Output Voltage Ripple
  - 700mA Output Drive Capability
  - Simple Logic ON/OFF Control
  - Tiny External Components
- ◆ Low-Noise LDOs
  - 2 x 300mA LDO
  - Pin-Selectable Output Voltage (LDO1)
  - Low 26 $\mu$ V<sub>RMS</sub> (typ) Output Noise
  - High 65dB (typ) PSRR
  - Simple Logic ON/OFF Control
- ◆ Low 0.1 $\mu$ A Shutdown Current
- ◆ 2.7V to 5.5V Supply Voltage Range
- ◆ Thermal Shutdown
- ◆ Tiny, 2mm x 2mm x 0.65mm CSP Package (4x4 Grid)

## Ordering Information

PART	PIN-PACKAGE	SWITCHING FREQUENCY
MAX8884YEREKE+T	16 CSP	2MHz
MAX8884ZEREKE+T	16 CSP	4MHz

**Note:** All devices are specified over the -40°C to +85°C operating temperature range.

+ Denotes a lead(Pb)-free/RoHS-compliant package.  
T = Tape and reel.

Typical Application Circuit appears at end of data sheet.

## Pin Configuration

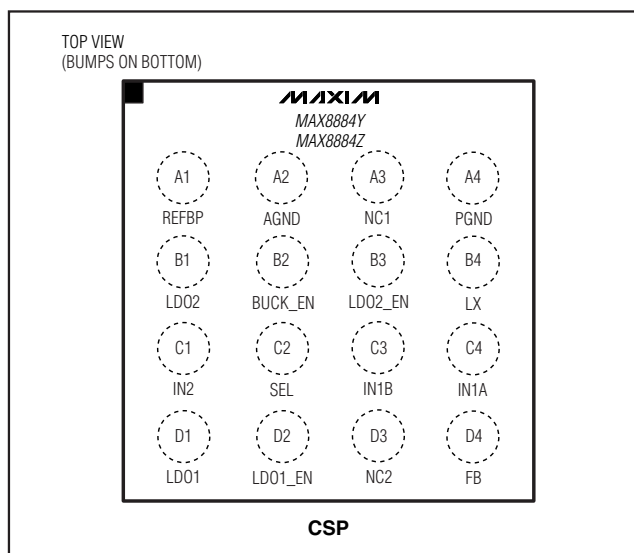

# 700mA DC-DC Step-Down Converters with Dual 300mA LDO in 2mm x 2mm CSP

## ABSOLUTE MAXIMUM RATINGS

IN1A, IN1B, IN2, REFBP to AGND .....-0.3V to +6.0V  
 FB to PGND .....-0.3V to +6.0V  
 SEL, BUCK\_EN to AGND.....-0.3V to (VIN1A/VIN1B + 0.3V)  
 LDO1, LDO2, LDO1\_EN, LDO2\_EN  
 to AGND .....-0.3V to (VIN2 + 0.3V)  
 IN2 to IN1A, IN1B .....-0.3V to +0.3V  
 AGND to PGND .....-0.3V to +0.3V

IN1A, IN1B, LX Current .....1ARMS  
 Continuous Power Dissipation (TA = +70°C)  
 16-Bump CSP (derate 12.5mW/°C above +70°C) .....1W  
 Operating Temperature .....-40°C to +85°C  
 Junction Temperature.....+150°C  
 Storage Temperature Range .....-65°C to +150°C  
 Bump Temperature\* .....+260°C

\*These ICs are constructed using a unique set of packaging techniques imposing a limit on the thermal profile used during board level solder attach and rework. This limit permits only the use of the solder profiles recommended in the industry-standard specification, JEDEC 020A, paragraph 7.6, Table 3 for IR/NPR and Convection reflow. Preheating is required. Hand or wave soldering is not allowed.

Stresses beyond those listed under "Absolute Maximum Ratings" may cause permanent damage to the device. These are stress ratings only, and functional operation of the device at these or any other conditions beyond those indicated in the operational sections of the specifications is not implied. Exposure to absolute maximum rating conditions for extended periods may affect device reliability.

## ELECTRICAL CHARACTERISTICS

(VIN1A = VIN1B = VIN2 = VLDO1\_EN = VLDO2\_EN = VBUCK\_EN = 3.6V. TA = -40°C to +85°C, typical values are at TA = +25°C, unless otherwise noted.) (Note 1)

PARAMETER	CONDITIONS	MIN	TYP	MAX	UNITS
<b>INPUT SUPPLY</b>					
Input Voltage	VIN1A, VIN1B, VIN2	2.7		5.5	V
Input Undervoltage Threshold	VIN1A, VIN1B, VIN2 rising, 180mV typical hysteresis	2.52	2.63	2.70	V
Shutdown Supply Current	VBUCK_EN = VLDO1_EN = VLDO2_EN = 0	TA = +25°C	0.1	4	µA
		TA = +85°C	0.1		
No-Load Supply Current	VBUCK_EN = 0, ILDO1 = ILDO2 = 0A		140	230	µA
	VLDO1_EN = VLDO2_EN = 0, IBUCK = 0A, no switching		50	80	µA
<b>THERMAL PROTECTION</b>					
Thermal Shutdown	TA rising, 20°C typical hysteresis		+160		°C
<b>LOGIC CONTROL</b>					
Logic Input-High Voltage (BUCK_EN, SEL, LDO1_EN, LDO2_EN)	2.7V ≤ VIN1A = VIN1B = VIN2 ≤ 5.5V	1.3			V
Logic Input-Low Voltage (BUCK_EN, SEL, LDO1_EN, LDO2_EN)	2.7V ≤ VIN1A = VIN1B = VIN2 ≤ 5.5V			0.4	V
Logic Input Current (BUCK_EN, SEL, LDO1_EN, LDO2_EN)	VIL = 0 or VIH = VIN1A = 5.5V	TA = +25°C	0.01	1	µA
		TA = +85°C	0.1		
<b>FB</b>					
Buck Converter Output Voltage	SEL = AGND, IBUCK = 0A	1.18	1.22	1.24	V
	VSEL = VIN1A, IBUCK = 0A	1.78	1.80	1.85	V
FB Leakage Current	VIN1A = VIN1B = VIN2 = 5.5V, VFB = 0	TA = +25°C	0.01	1	µA
		TA = +85°C	1		
<b>LX</b>					
On-Resistance	p-channel MOSFET switch, ILX = -40mA		0.18	0.30	Ω
	n-channel MOSFET rectifier, ILX = 40mA		0.15	0.25	

# 700mA DC-DC Step-Down Converters with Dual 300mA LDO in 2mm x 2mm CSP

MAX8884Y/MAX8884Z

## ELECTRICAL CHARACTERISTICS (continued)

( $V_{IN1A} = V_{IN1B} = V_{IN2} = V_{LDO1\_EN} = V_{LDO2\_EN} = V_{BUCK\_EN} = 3.6V$ .  $T_A = -40^{\circ}C$  to  $+85^{\circ}C$ , typical values are at  $T_A = +25^{\circ}C$ , unless otherwise noted.) (Note 1)

PARAMETER	CONDITIONS	MIN	TYP	MAX	UNITS	
LX Leakage Current	$V_{IN1A} = V_{IN1B} = V_{IN2} = 5.5V$ , $V_{LX} = 0$	$T_A = +25^{\circ}C$	0.1	1	$\mu A$	
		$T_A = +85^{\circ}C$	1			
p-Channel MOSFET Peak Current Limit	$V_{LX} = 0$	0.8	1.0	1.2	A	
n-Channel MOSFET Valley Current Limit		0.6	0.8	1.0	A	
n-Channel MOSFET Zero-Crossing Threshold	MAX8884Y_		40		mA	
	MAX8884Z_		60			
Minimum On-Time			0.07		$\mu s$	
Minimum Off-Time			0.06		$\mu s$	
Power-Up Delay	From $V_{BUCK\_EN}$ rising to $V_{LX}$ rising		120	250	$\mu s$	
<b>LDO1, LDO2</b>						
Output Voltage $V_{LDO1}$	$V_{IN2} = 5.5V$ , $I_{LDO\_} = 1mA$ ; $V_{IN2} = 3.4V$ , $I_{LDO\_} = 100mA$	SEL = AGND	1.764	1.800	1.836	V
		SEL = IN1_		2.800		
Output Voltage $V_{LDO2}$	$V_{IN2} = 5.5V$ , $I_{LDO\_} = 1mA$ ; $V_{IN2} = 3.4V$ , $I_{LDO\_} = 100mA$	2.770	2.800	2.830	V	
Output Current		300			mA	
Current Limit	$V_{LDO\_} = 0$	310	450	750	mA	
Dropout Voltage	$I_{LDO\_} = 100mA$ , $T_A = +25^{\circ}C$ ( $V_{LDO\_} \geq 2.5V$ )		70	200	mV	
Line Regulation	$V_{IN2}$ stepped from 3.5V to 5.5V, $I_{LDO\_} = 100mA$		2.4		mV	
Load Regulation	$I_{LDO\_}$ stepped from 50 $\mu A$ to 200mA		25		mV	
Power-Supply Rejection $\Delta V_{LDO\_}/\Delta V_{IN2}$	10Hz to 100kHz, $V_{LDO\_} = 1.8V$ , $C_{LDO\_} = 2.2\mu F$ , $I_{LDO\_} = 30mA$		65		dB	
Output Noise	10Hz to 100kHz, $V_{LDO\_} = 1.8V$ , $C_{LDO\_} = 2.2\mu F$ , $I_{LDO\_} = 30mA$		26		$\mu VRMS$	
Output Capacitor for Stable Operation	$0 < I_{LDO\_} < 10mA$		0.1		$\mu F$	
	$10mA < I_{LDO\_} < 200mA$		1			
	$200mA < I_{LDO\_} < 300mA$		2.2			
Shutdown Output Impedance	$V_{LDO1\_EN} = V_{LDO2\_EN} = 0$		100		$\Omega$	
Power-Up Delay	From $V_{LDO\_EN}$ rising to $V_{LDO\_}$ output rising		150	250	$\mu s$	
<b>REFBP</b>						
REFBP Output Voltage	$0 \leq I_{REFBP} \leq 1\mu A$	1.237	1.250	1.263	V	
REFBP Supply Rejection	$V_{IN2}$ stepped from 2.55V to 5.5V		0.2	5	mV	

**Note 1:** All devices are 100% production tested at  $T_A = +25^{\circ}C$ . Limits over the operating temperature range are guaranteed by design.

# 700mA DC-DC Step-Down Converters with Dual 300mA LDO in 2mm x 2mm CSP

## Typical Operating Characteristics

( $V_{IN} = V_{IN1A} = V_{IN1B} = V_{IN2} = 3.6V$ ,  $V_{BUCK} = 1.2V$ ,  $V_{LDO1} = 1.8V$ ,  $V_{LDO2} = 2.8V$ , MAX8884YEVKIT,  $T_A = +25^\circ C$ , unless otherwise noted.)

**STEP-DOWN CONVERTER EFFICIENCY vs. LOAD CURRENT,  $V_{OUT} = 1.8V$**

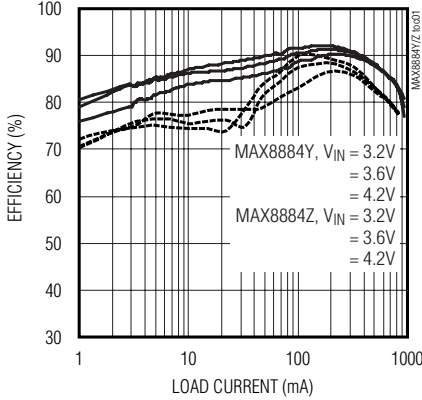

**STEP-DOWN CONVERTER EFFICIENCY vs. LOAD CURRENT,  $V_{OUT} = 1.2V$**

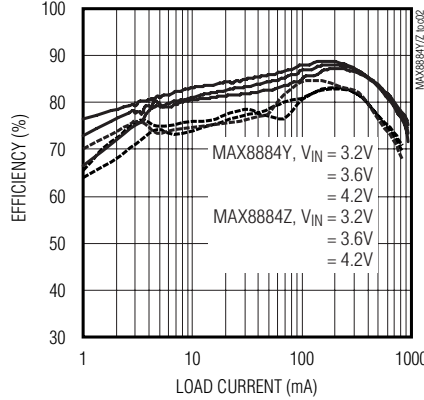

**STEP-DOWN CONVERTER NO-LOAD SUPPLY CURRENT vs. INPUT VOLTAGE**

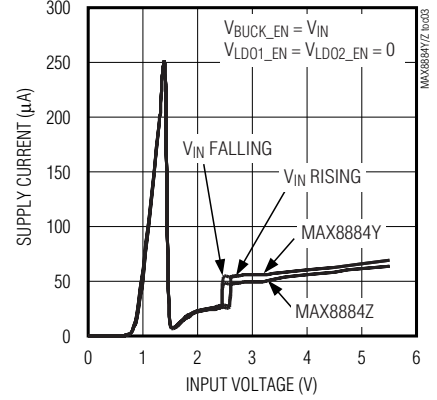

**STEP-DOWN OUTPUT VOLTAGE vs. LOAD CURRENT (VOLTAGE POSITIONING)**

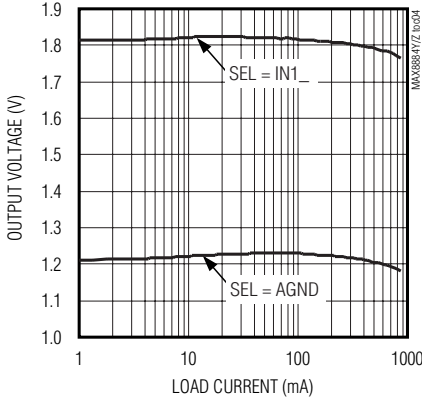

**MAX8884Z STEP-DOWN CONVERTER LIGHT LOAD SWITCHING WAVEFORMS**

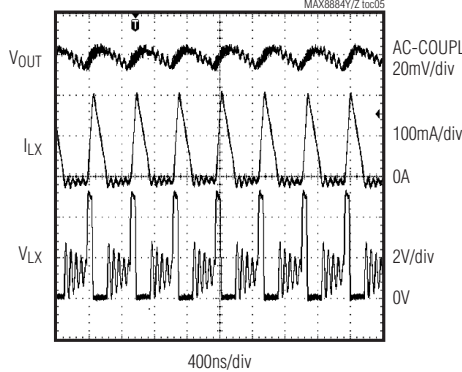

**MAX8884Y STEP-DOWN CONVERTER LIGHT LOAD SWITCHING WAVEFORMS**

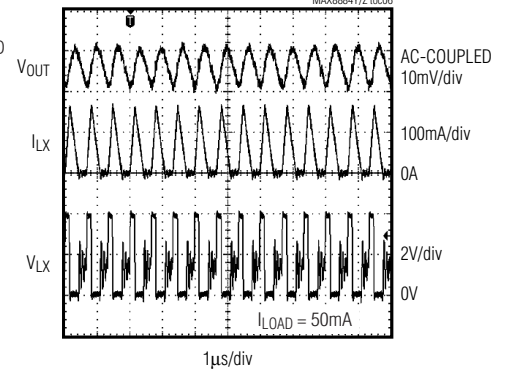

**MAX8884Z STEP-DOWN CONVERTER HEAVY LOAD SWITCHING WAVEFORMS**

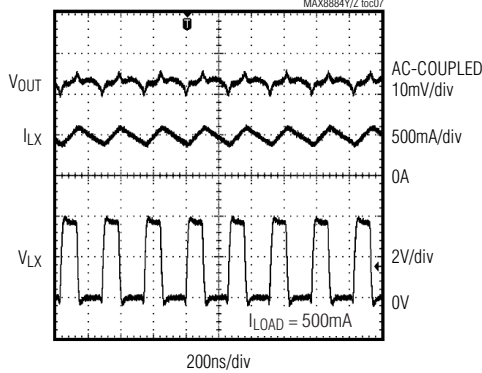

**MAX8884Y STEP-DOWN CONVERTER HEAVY LOAD SWITCHING WAVEFORMS**

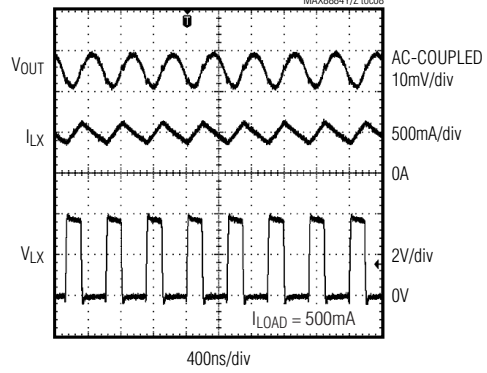

# 700mA DC-DC Step-Down Converters with Dual 300mA LDO in 2mm x 2mm CSP

## Typical Operating Characteristics (continued)

( $V_{IN} = V_{IN1A} = V_{IN1B} = V_{IN2} = 3.6V$ ,  $V_{BUCK} = 1.2V$ ,  $V_{LDO1} = 1.8V$ ,  $V_{LDO2} = 2.8V$ , MAX8884YEVKIT,  $T_A = +25^\circ C$ , unless otherwise noted.)

MAX8884Y/MAX8884Z

**MAX8884Z STEP-DOWN CONVERTER  
SOFT-START WAVEFORMS**

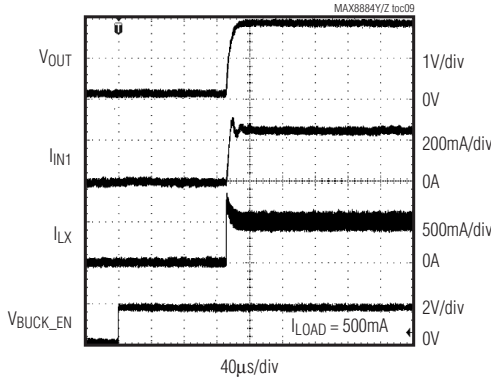

**MAX8884Y STEP-DOWN CONVERTER  
SOFT-START WAVEFORMS**

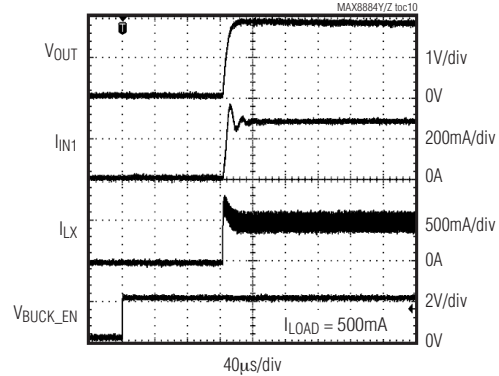

**MAX8884Y STEP-DOWN CONVERTER  
LINE TRANSIENT RESPONSE**

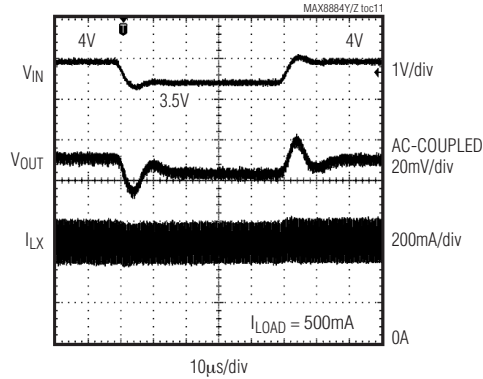

**MAX8884Z STEP-DOWN CONVERTER  
LINE TRANSIENT RESPONSE**

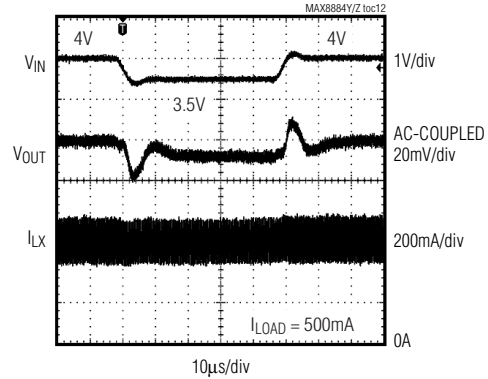

**MAX8884Z STEP-DOWN CONVERTER  
LOAD TRANSIENT**

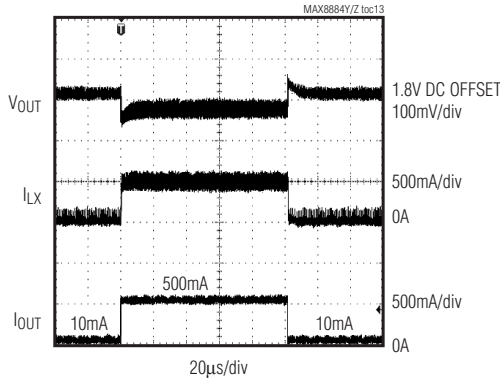

**MAX8884Y STEP-DOWN CONVERTER  
LOAD TRANSIENT**

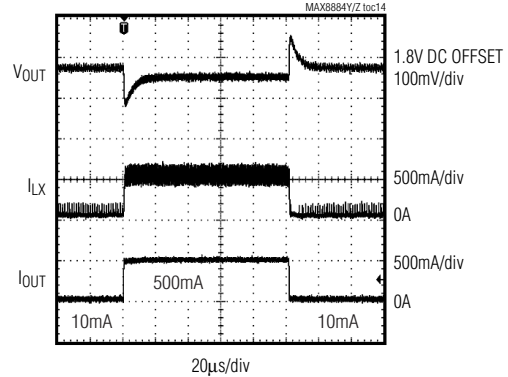

# 700mA DC-DC Step-Down Converters with Dual 300mA LDO in 2mm x 2mm CSP

## Typical Operating Characteristics (continued)

( $V_{IN} = V_{IN1A} = V_{IN1B} = V_{IN2} = 3.6V$ ,  $V_{BUCK} = 1.2V$ ,  $V_{LDO1} = 1.8V$ ,  $V_{LDO2} = 2.8V$ , MAX8884YEVKIT,  $T_A = +25^\circ C$ , unless otherwise noted.)

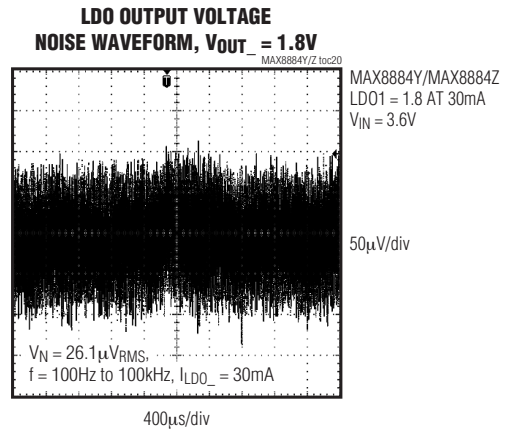
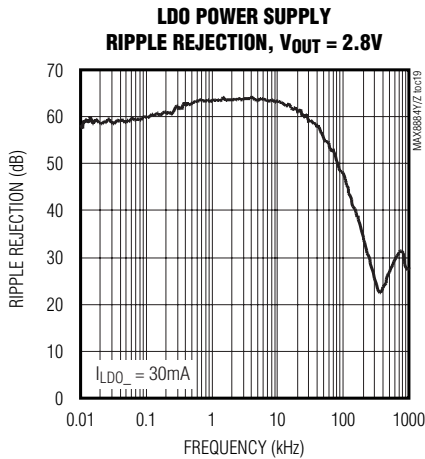
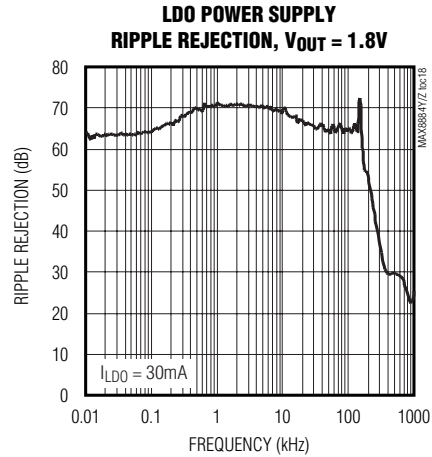
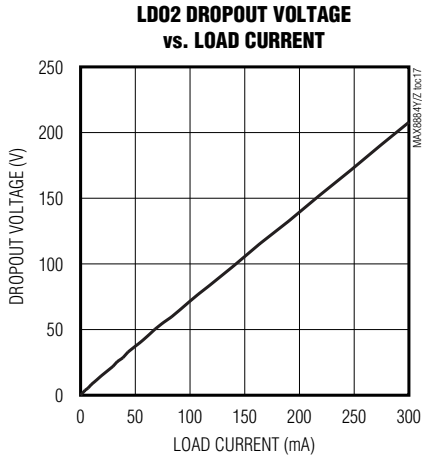
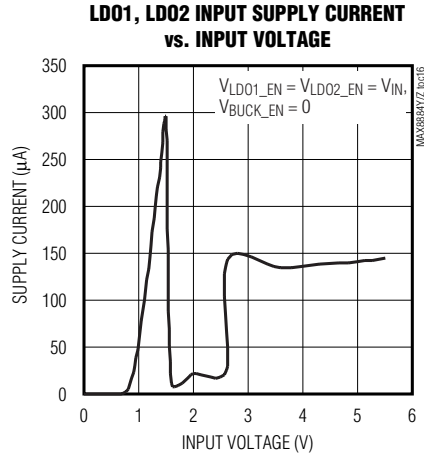
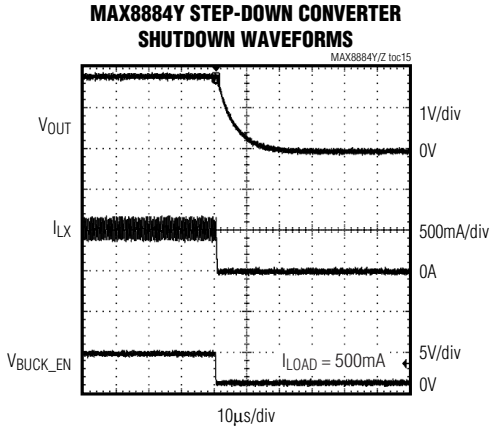

# 700mA DC-DC Step-Down Converters with Dual 300mA LDO in 2mm x 2mm CSP

## Typical Operating Characteristics (continued)

( $V_{IN} = V_{IN1A} = V_{IN1B} = V_{IN2} = 3.6V$ ,  $V_{BUCK} = 1.2V$ ,  $V_{LDO1} = 1.8V$ ,  $V_{LDO2} = 2.8V$ , MAX8884YEVKIT,  $T_A = +25^\circ C$ , unless otherwise noted.)

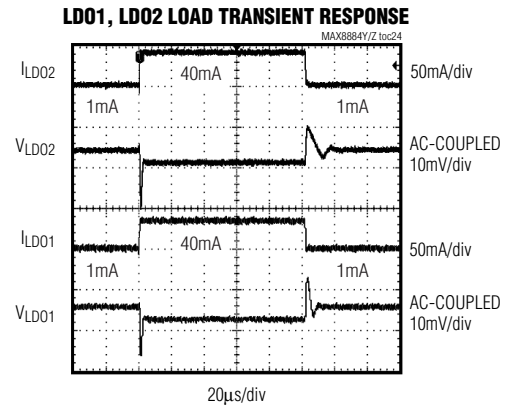
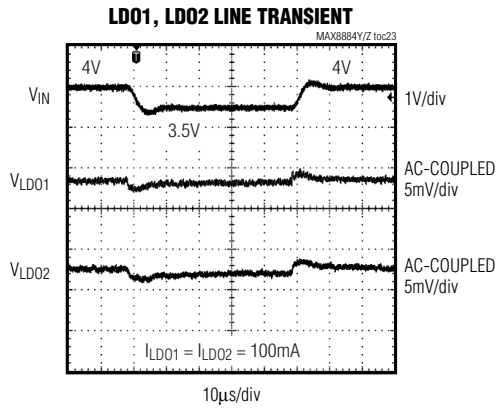
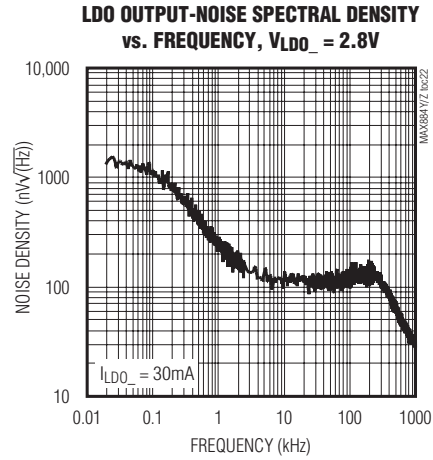
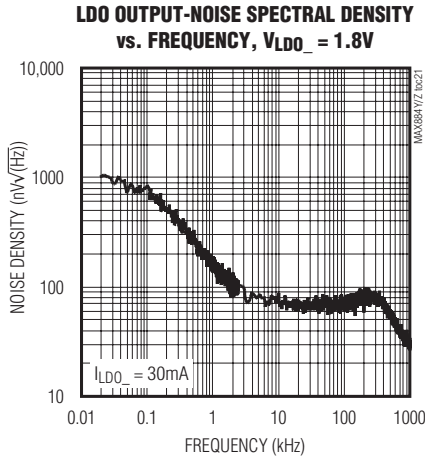

MAX8884Y/MAX8884Z

# 700mA DC-DC Step-Down Converters with Dual 300mA LDO in 2mm x 2mm CSP

## Typical Operating Characteristics (continued)

( $V_{IN} = V_{IN1A} = V_{IN1B} = V_{IN2} = 3.6V$ ,  $V_{BUCK} = 1.2V$ ,  $V_{LDO1} = 1.8V$ ,  $V_{LDO2} = 2.8V$ , MAX8884YEVKIT,  $T_A = +25^\circ C$ , unless otherwise noted.)

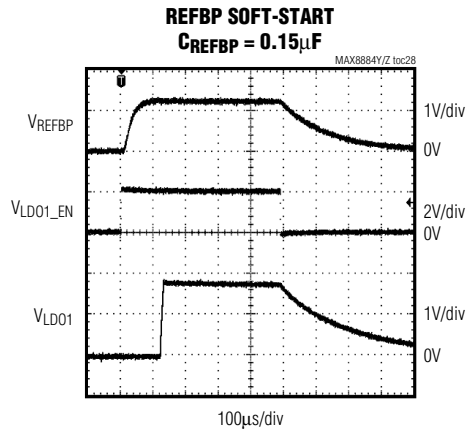
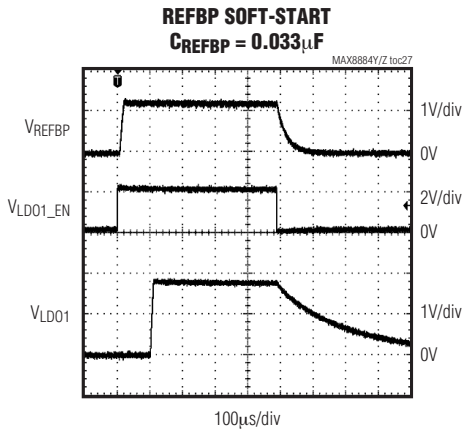
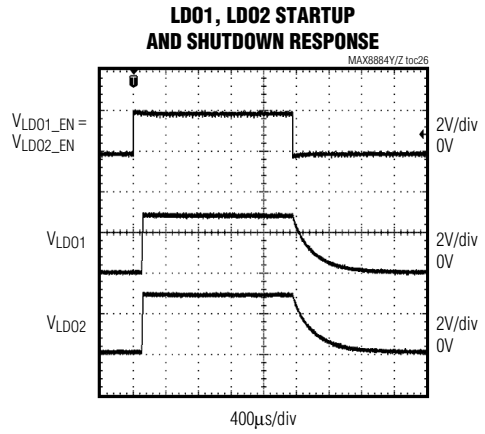
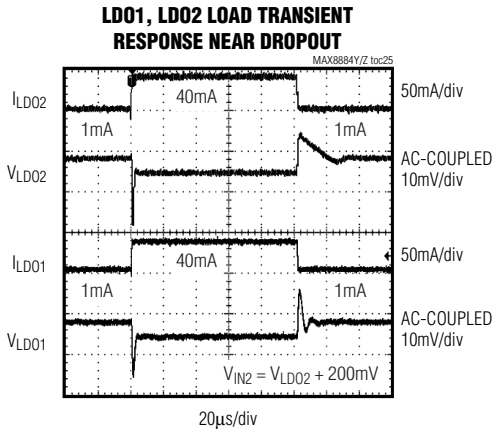



# 700mA DC-DC Step-Down Converters with Dual 300mA LDO in 2mm x 2mm CSP

## Pin Description

PIN	NAME	FUNCTION
A1	REFBP	Reference Noise Bypass. Bypass REFBP to AGND with a 0.033 $\mu$ F ceramic capacitor to reduce noise on the LDO outputs. REFBP is internally pulled to ground through a 1k $\Omega$ resistor during shutdown.
A2	AGND	Low-Noise Analog Ground. Connect to common ground plane.
A3	NC1	No Internal Connection. Connect NC1 to ground.
A4	PGND	Power Ground for Step-Down Converter. Connect to common ground plane.
B1	LDO2	300mA LDO Regulator 2 Output. For 300mA application, bypass LDO2 with a 2.2 $\mu$ F ceramic capacitor as close as possible to LDO2 and AGND. For low-output current capability, up to 10mA, an output capacitor of 0.1 $\mu$ F is sufficient to keep the output voltage stable. LDO2 is internally pulled to ground through a 100 $\Omega$ resistor when this regulator is disabled.
B2	BUCK_EN	Step-Down Converter Enable Input. Connect BUCK_EN to IN1_ or logic-high for normal operation. Connect BUCK_EN to AGND or logic-low for step-down shutdown mode.
B3	LDO2_EN	LDO2 Enable Input. Connect LDO2_EN to IN2 or logic-high for normal operation. Connect LDO2_EN to AGND or logic-low for LDO2 shutdown mode.
B4	LX	Inductor Connection. Connect an inductor from LX to the output of the step-down converter.
C1	IN2	Supply Voltage Input for LDO1, LDO2, and Internal Reference. Connect IN2 to a battery or supply voltage from 2.7V to 5.5V. Bypass IN2 with a 4.7 $\mu$ F ceramic capacitor as close as possible to IN2 and AGND. Connect IN2 to the same source as IN1A and IN1B.
C2	SEL	Output Voltage Selection for LDO1 and Step-Down Converter. Connect to IN1_ or AGND for output voltage selection. See Table 1.
C3, C4	IN1B, IN1A	Supply Voltage Input for Step-Down Converter. Connect IN1B and IN1A to a battery or supply voltage from 2.7V to 5.5V. Bypass the connection of IN1B and IN1A with a 2.2 $\mu$ F ceramic capacitor as close as possible to IN1B, IN1A, and PGND. IN1A and IN1B are internally connected together. Connect IN1A and IN1B to the same source as IN2.
D1	LDO1	300mA LDO Regulator 1 Output. For 300mA application, bypass LDO1 with a 2.2 $\mu$ F ceramic capacitor as close as possible to LDO1 and AGND. For low-output current capability, up to 10mA, an output capacitor of 0.1 $\mu$ F is sufficient to keep output voltage stable. LDO1 is internally pulled to AGND through a 100 $\Omega$ resistor when this regulator is disabled.
D2	LDO1_EN	LDO1 Enable Input. Connect LDO1_EN to IN2 or logic-high for normal operation. Connect LDO1_EN to AGND or logic-low for LDO1 shutdown mode.
D3	NC2	No Internal Connection. Connect NC2 to ground.
D4	FB	FB is Connected to the Internal Feedback Network

## Detailed Description

The MAX8884Y/MAX8884Z are designed to power the subcircuits within a system. These ICs contain a high-frequency, high-efficiency step-down converter and two LDOs. The step-down converter delivers 700mA with either 1.2V or 1.8V selectable output voltage using SEL. The hysteretic PWM control scheme provides extremely fast transient response, while 2MHz and 4MHz switching frequency options allow the trade-off between efficiency and the smallest external components. The MAX8884Y/MAX8884Z linear regulators can be used to power loads requiring a low output noise supply.

## Step-Down Converter Control Scheme

A hysteretic PWM control scheme ensures high efficiency, fast switching, fast transient response, low-output voltage ripple, and physically tiny external components. The control scheme is simple: when the output voltage is below the regulation threshold, the error comparator begins a switching cycle by turning on the high-side switch. This high-side switch remains on until the minimum on-time expires and output voltage is within regulation, or the inductor current is above the current-limit threshold. Once off, the high-side switch remains off until the minimum off-time expires and the output voltage falls again below the regulation threshold. During

# 700mA DC-DC Step-Down Converters with Dual 300mA LDO in 2mm x 2mm CSP

the off period, the low-side synchronous rectifier turns on and remains on until the high-side switch turns on again. The internal synchronous rectifier eliminates the need for an external Schottky diode.

At inductor currents below 40mA (60mA), the MAX8884Y (MAX8884Z) automatically switches to pulse-skipping mode to improve light-load efficiency. Output voltage ripple remains low at all loads, while the skip-mode switching frequency remains ultrasonic down to 1mA (typ) loads.

## Voltage Positioning Load Regulation

The MAX8884Y/MAX8884Z step-down converters utilize a unique feedback network. By taking a DC feedback from the LX node through R1 in the *Block Diagram*, the usual phase lag due to the output capacitor is removed, making the loop exceedingly stable and allowing the use of very small ceramic output capacitors. To improve the load regulation, resistor R3 is included in the feedback (see the *Block Diagram*). This configuration yields load regulation equal to half the inductor's series resistance multiplied by the load current. This voltage positioning load regulation greatly reduces overshoot during load transients.

$$V_{\text{BUCK}} = V_{\text{BUCK\_NO\_LOAD}} - \frac{I_{\text{LOAD}} \times R_{\text{DCR}}}{2}$$

$I_{\text{LOAD}}$  = load current

$R_{\text{DCR}}$  = DC impedance of inductor

$V_{\text{BUCK\_NO\_LOAD}}$  = 1.2V or 1.8V depending on SEL

## SEL Output Voltage Selection

SEL is used to determine the output voltage of the buck converter and LDO1. See Table 1.

## Shutdown Mode

Drive BUCK\_EN to logic-low to place the MAX8884Y/MAX8884Z step-down converter in shutdown mode. In shutdown, the control circuitry, internal switching MOSFET, and synchronous rectifier turn off and LX becomes high impedance.

The LDOs are individually enabled. Connect LDO1\_EN and LDO2\_EN to GND or logic-low to place LDO1 and LDO2 in shutdown mode. In shutdown, the outputs of the LDOs are pulled to ground through an internal 100Ω resistor.

When the step-down converter and all LDOs are in shutdown, the MAX8884Y/MAX8884Z enter a very low-power state, where the input current drops to 0.1μA (typ).

Table 1. SEL Output Voltage Selection

SEL	BUCK CONVERTER OUTPUT VOLTAGE (V)	LDO1 OUTPUT VOLTAGE (V)
AGND	1.2	1.8
IN1_	1.8	2.8

## Step-Down Converter Soft-Start

The MAX8884Y/MAX8884Z step-down converter uses internal soft-start circuitry to limit inrush current at startup, reducing transients on the input source. Soft-start is particularly useful for supplies with high output impedance such as Li+ and alkaline cells. See the soft-start waveforms in the *Typical Operating Characteristics*.

## Thermal Shutdown

Thermal shutdown limits total power dissipation in the MAX8884Y/MAX8884Z. If the junction temperature exceeds +160°C, thermal shutdown circuitry turns off the MAX8884Y/MAX8884Z, allowing the ICs to cool. The ICs turn on and begin soft-start after the junction temperature cools by 20°C. This results in a pulsed output during continuous thermal-overload conditions.

## Applications Information

### Output Voltages

The MAX8884Y/MAX8884Z DC-DC step-down converter sets the BUCK and LDO1 output voltage based on the state of SEL. See Table 1.

Contact the factory for other output voltage options.

### LDO Dropout Voltage

The regulator's minimum input/output differential (or dropout voltage) determines the lowest usable supply voltage. In battery-powered systems, this determines the useful end-of-life battery voltage. Because the MAX8884Y/MAX8884Z LDOs use a p-channel MOSFET pass transistor, their dropout voltages are a function of drain-to-source on-resistance ( $R_{\text{DS(ON)}}$ ) multiplied by the load current (see the *Typical Operating Characteristics*).

### Inductor Selection

The MAX8884Y operates with a switching frequency of 2MHz and utilizes a 2.2μH inductor. The MAX8884Z operates with a switching frequency of 4MHz and utilizes a 1μH inductor. The higher switching frequency of the MAX8884Z allows the use of physically smaller inductors at the cost of lower efficiency. The lower switching frequency of the MAX8884Y results in greater efficiency at the cost of a physically larger inductor. See the *Typical Operating Characteristics* for efficiency graphs for both the MAX8884Y and the MAX8884Z.

# 700mA DC-DC Step-Down Converters with Dual 300mA LDO in 2mm x 2mm CSP

MAX8884Y/MAX8884Z

The inductor's DC current rating only needs to match the maximum load of the application because the MAX8884Y/MAX8884Z feature zero current overshoot during startup and load transients. For optimum transient response and high efficiency, choose an inductor with DC series resistance in the 50mΩ to 150mΩ range. See Table 2 for suggested inductors and manufacturers.

## Output Capacitor Selection

For the DC-DC step-down converter, the output capacitor  $C_{BUCK}$  is required to keep the output voltage ripple small and ensure regulation loop stability.  $C_{BUCK}$  must have low impedance at the switching frequency. Ceramic capacitors with X5R or X7R dielectric are highly recommended due to their small size, low ESR, and small temperature coefficients. Due to the unique feedback network, the output capacitance can be very low. A 2.2μF ceramic capacitor is recommended for most applications. For optimum load-transient performance and very low output ripple, the output capacitor value can be increased.

For LDO1 and LDO2, the minimum output capacitance required is dependent on the load currents. For loads lighter than 10mA, it is sufficient to use a 0.1μF ceramic capacitor for stable operation over the full temperature range. For loads up to 200mA, an output capacitor of 1μF is sufficient for stable operation over the entire temperature range. Operating the LDO at maximum rated current the LDO1 and LDO2 requires a 2.2μF ceramic capacitor. Using larger output capacitors reduces output noise and improves load-transient response, stability, and power-supply rejection.

Note that some ceramic dielectrics exhibit large capacitance and ESR variation with temperature. With dielectrics such as Z5U and Y5V, it is necessary to use 4.7μF or more to ensure stability at temperatures below -10°C. With X7R or X5R dielectrics, 2.2μF is sufficient at all operating temperatures. These regulators are optimized for ceramic capacitors. Tantalum capacitors are not recommended.

## Input Capacitor Selection

The input capacitor ( $C_{IN1}$ ) of the DC-DC step-down converter reduces the current peaks drawn from the battery or input power source and reduces switching noise in the MAX8884Y/MAX8884Z. The impedance of  $C_{IN1}$  at the switching frequency should be kept very low. Ceramic capacitors with X5R or X7R dielectric are highly recommended due to their small size, low ESR, and small temperature coefficients. A 2.2μF ceramic capacitor is recommended for most applications. For optimum noise immunity and low input ripple, the input capacitor value can be increased.

For the LDOs, use an input capacitance equal to the value of the sum of the output capacitance of LDO1 and

LDO2. Larger input capacitor values and lower ESR provide better noise rejection and line transient response.

Note that some ceramic dielectrics exhibit large capacitance and ESR variation with temperature. With dielectrics such as Z5U and Y5V, it may be necessary to use two times the sum of the output capacitor value of LDO1 and LDO2 (or larger) to ensure stability at temperatures below -10°C. With X7R or X5R dielectrics, a capacitance equal to the sum is sufficient at all operating temperatures.

## Reference Noise Bypass Capacitor Selection

The REFBP capacitor reduces the output noise of LDO1 and LDO2. A value of 0.033μF is sufficient for most applications. This value can be increased up to 0.150μF with some effect on the soft-start time of the LDOs. See the *Typical Operating Characteristics* for more information. Do not use values greater than 0.150μF as this degrades the performance of the internal reference voltage and has a corresponding impact on all output voltages.

Ceramic capacitors with X5R or X7R dielectric are highly recommended due to their small size, low ESR, and small temperature coefficients. Note that some ceramic dielectrics exhibit large capacitance and ESR variation with temperature. With dielectrics such as Z5U and Y5V, it may be necessary to use two times the recommended value to achieve desired output noise performance at temperatures below -10°C. Tantalum capacitors are not recommended.

## Thermal Considerations

In most applications, the MAX8884Y/MAX8884Z do not dissipate much heat due to their high efficiency. But in applications where the MAX8884Y/MAX8884Z run at high ambient temperature with heavy loads, the heat dissipated may exceed the maximum junction temperature of the part. If the junction temperature reaches approximately +160°C, all power switches are turned off and LX and FB become high impedance, and LDO1 and LDO2 are pulled down to ground through an internal 100Ω resistor.

The MAX8884Y/MAX8884Z maximum power dissipation depends on the thermal resistance of the IC package and circuit board, the temperature difference between the die junction and ambient air, and the rate of airflow. The power dissipated in the device,  $P_{DISS}$ , is:

$$P_{DISS} = P_{BUCK} \left( \frac{1}{\eta_{BUCK}} - 1 \right) + I_{LDO1}(V_{IN2} - V_{LDO1}) + I_{LDO2}(V_{IN2} - V_{LDO2})$$

where  $\eta_{BUCK}$  is the efficiency of the DC-DC step-down converter, and  $P_{BUCK}$  is the output power of the DC-DC step-down converter.

## 700mA DC-DC Step-Down Converters with Dual 300mA LDO in 2mm x 2mm CSP

Table 2. Suggested Inductors

MANUFACTURER	SERIES	INDUCTANCE ( $\mu$ H)	ESR ( $\Omega$ )	CURRENT RATING (mA)	DIMENSIONS (mm)
Taiyo Yuden	CB2016T	1.0	0.09	510	2.0 x 1.6 x 1.8 = 5.8mm <sup>3</sup>
		2.2	0.13		
	CB2518T	2.2	0.09	510	2.5 x 1.8 x 2.0 = 9mm <sup>3</sup>
		4.7	0.13	340	
FDK	MIPF2520	1.0	0.05	1500	2.5 x 2.0 x 1.0 = 5mm <sup>3</sup>
		1.5	0.07	1500	
		2.2	0.08	1300	
	MIPF2016	1.0	0.11	1100	2.0 x 1.6 x 1.0 = 3.2mm <sup>3</sup>
		2.2			
Murata	LQH32C_53	1.0	0.06	1000	3.2 x 2.5 x 1.7 = 14mm <sup>3</sup>
		2.2	0.10	790	
TOKO	D3010FB	1.0	0.20	1170	3.0 x 3.0 x 1.0 = 9mm <sup>3</sup>
	D2812C	1.2	0.09	860	3.0 x 3.0 x 1.2 = 11mm <sup>3</sup>
		2.2	0.15	640	
D310F	1.5	0.13	1230	3.6 x 3.6 x 1.0 = 13mm <sup>3</sup>	
	2.2	0.17	1080		
D312C	1.5	0.10	1290	3.6 x 3.6 x 1.2 = 16mm <sup>3</sup>	
	2.2	0.12	1140		
Sumida	CDRH2D09	1.2	0.08	590	3.0 x 3.0 x 1.0 = 9mm <sup>3</sup>
		1.5	0.09	520	
		2.2	0.12	440	
	CDRH2D11	1.5	0.05	680	3.2 x 3.2 x 1.2 = 12mm <sup>3</sup>
		2.2	0.08	580	
		3.3	0.10	450	
Coilcraft	LPO3310	1.0	0.07	1600	3.3 x 3.3 x 1.0 = 11mm <sup>3</sup>
		1.5	0.10	1400	
		2.2	0.13	1100	
Panasonic	ELC3FN	1.0	0.08	1400	3.2 x 3.2 x 1.2 = 12mm <sup>3</sup>
		2.2	0.12	1000	
	ELL3GM	1.0	0.07	1400	3.2 x 3.2 x 1.5 = 15mm <sup>3</sup>
		2.2	0.10	1100	
Hitachi	KSLI-252010	1.5	0.070	2200	2.5 x 2.0 x 1.0 = 5mm <sup>3</sup>
		2.2	0.100	1800	

# 700mA DC-DC Step-Down Converters with Dual 300mA LDO in 2mm x 2mm CSP

The maximum allowed power dissipation,  $P_{MAX}$ , is:

$$P_{MAX} = \frac{(T_{J\_MAX} - T_A)}{\theta_{JA}}$$

where  $(T_{J\_MAX} - T_A)$  is the temperature difference between the MAX8884Y/MAX8884Z die junction and the surrounding air, and  $\theta_{JA}$  is the thermal resistance of the junction through the PCB, copper traces, and other materials to the surrounding air.

## PCB Layout

High switching frequencies and relatively large peak currents make the PCB layout a very important part of design. Good design minimizes excessive EMI on the feedback paths and voltage gradients in the ground plane, resulting in a stable and well regulated output. Minimize the ground loop formed by  $C_{IN1}$ ,  $C_{BUCK}$ , and PGND. To do this, connect  $C_{IN1}$  close to IN1A/IN1B and PGND. Connect the inductor and output capacitor as close as possible to the IC and keep their traces short, direct, and wide. Keep noisy traces, such as the LX node, as short as possible. Connect AGND and PGND to the common ground plane. Figure 1 illustrates an example PCB layout and routing scheme.

MAX8884Y/MAX8884Z

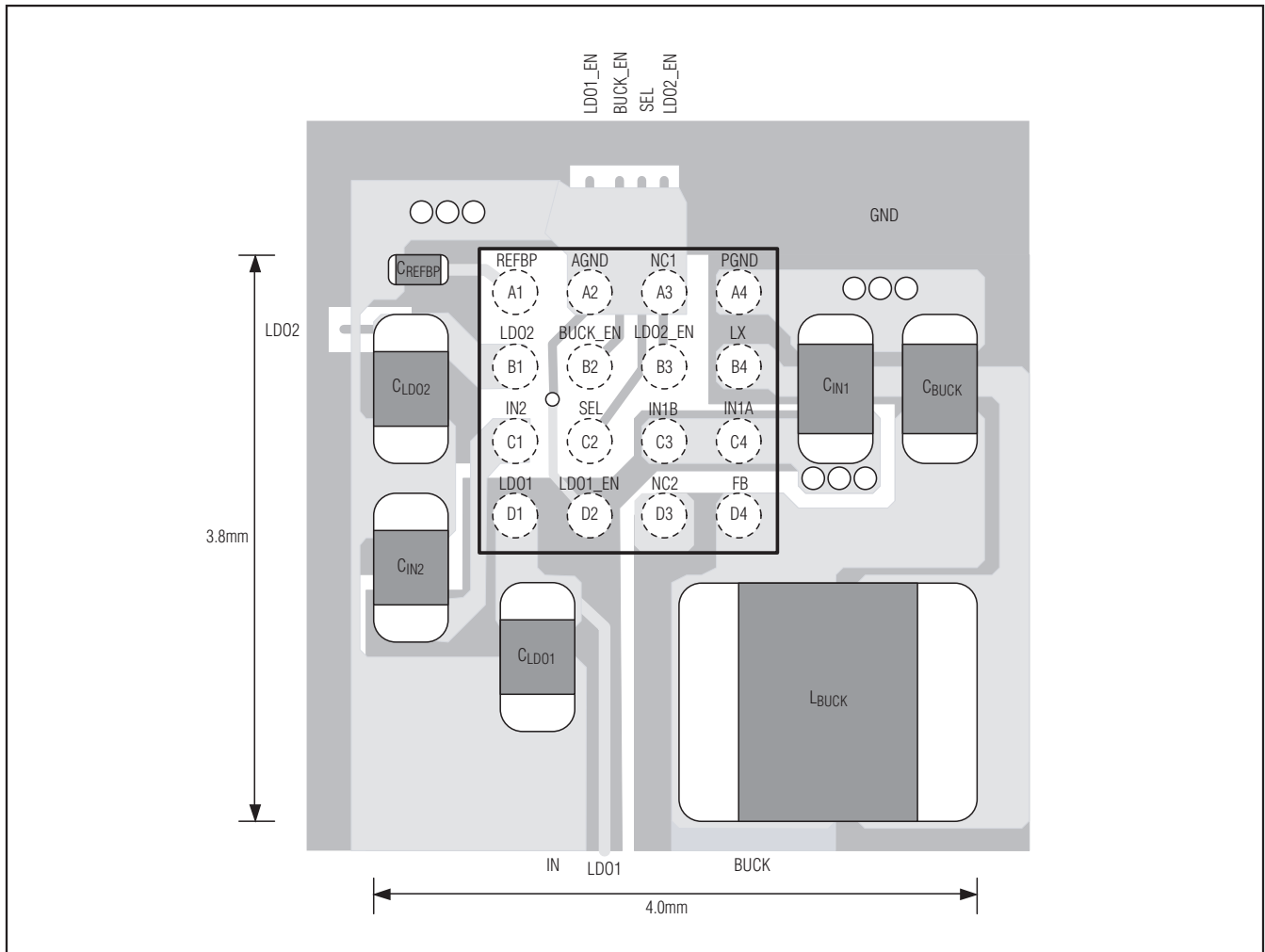
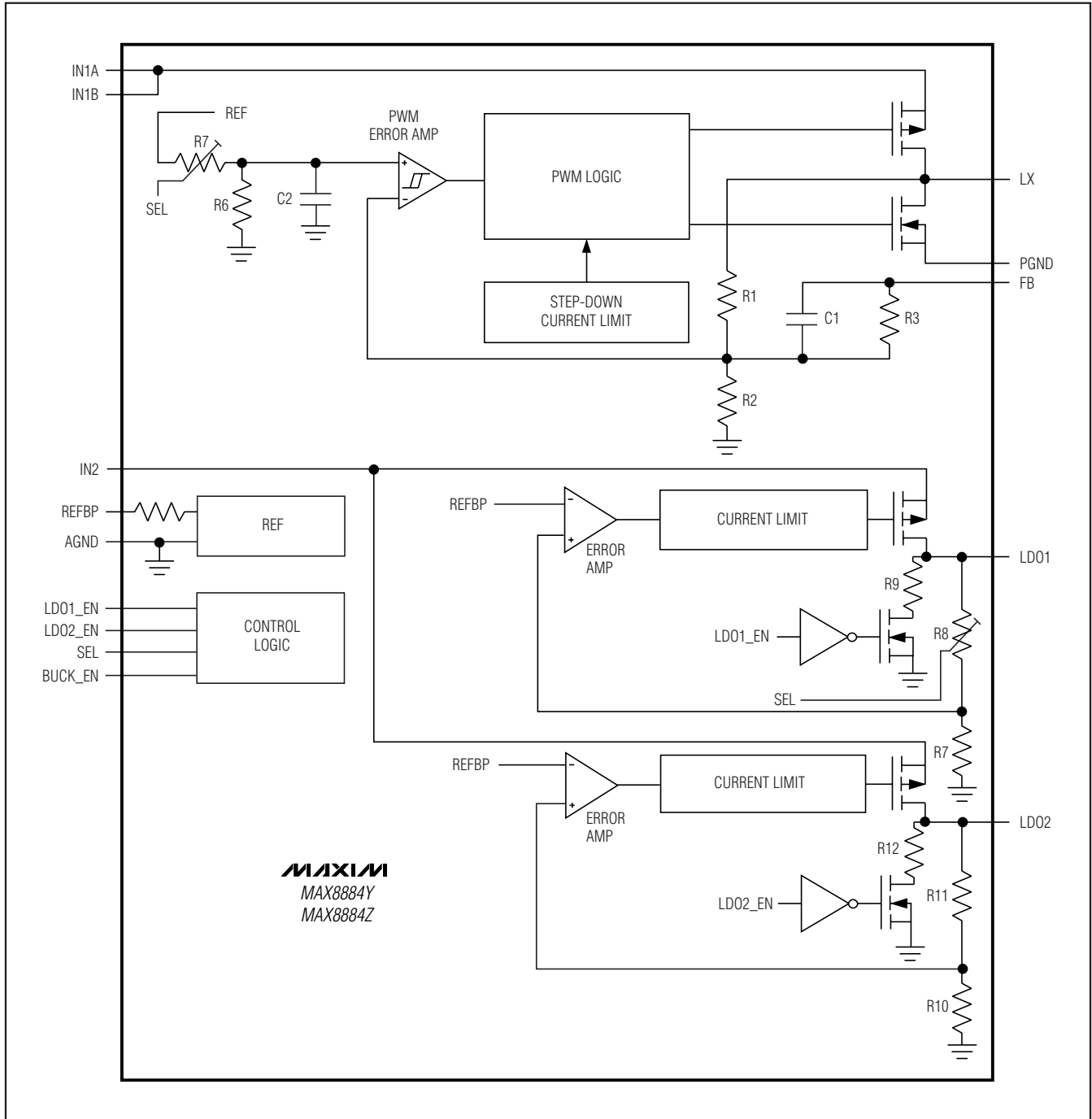

Figure 1. Recommended PCB Layout

# 700mA DC-DC Step-Down Converters with Dual 300mA LDO in 2mm x 2mm CSP

## Block Diagram



# 700mA DC-DC Step-Down Converters with Dual 300mA LDO in 2mm x 2mm CSP

## Typical Application Circuit

MAX8884Y/MAX8884Z

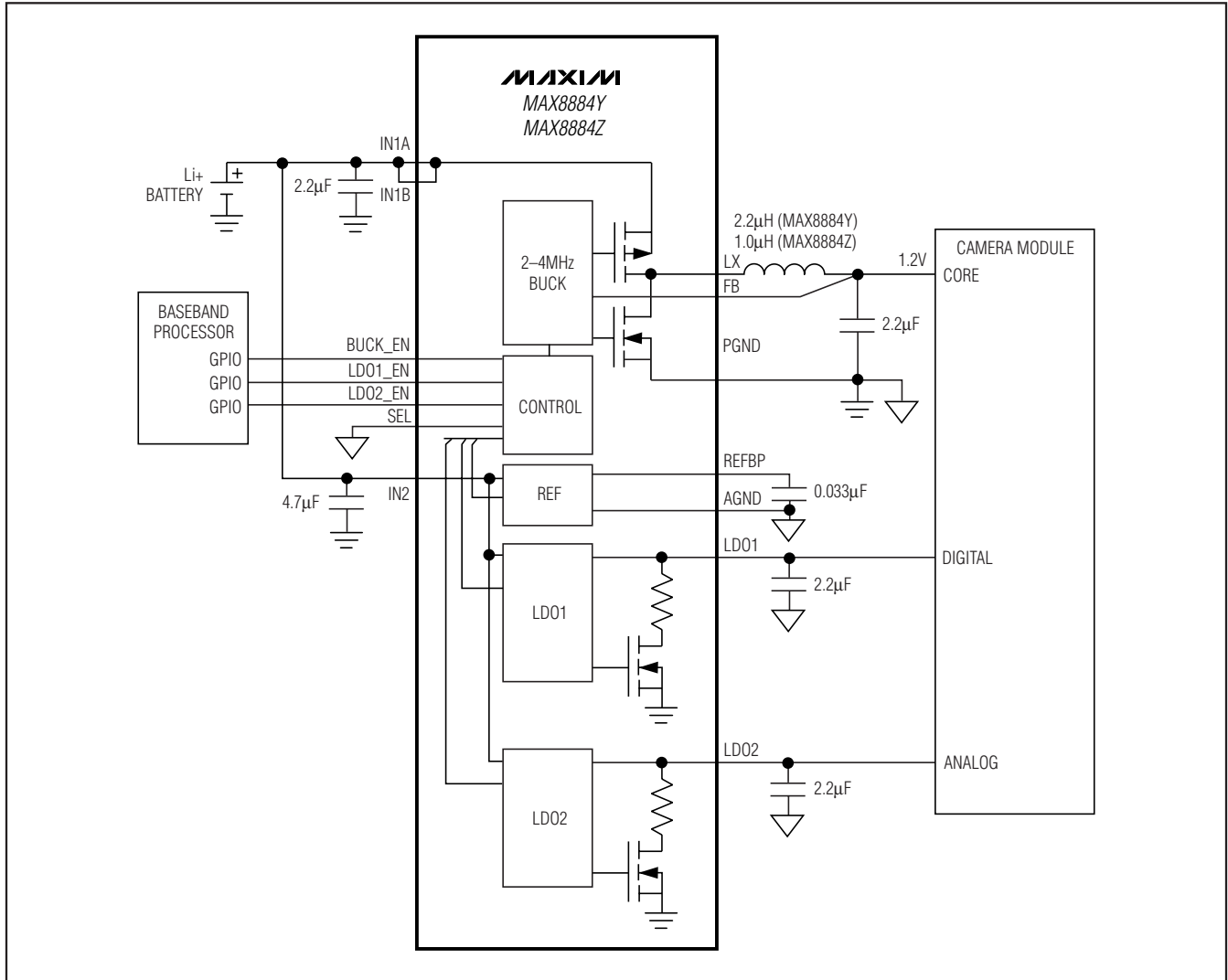

## Package Information

For the latest package outline information and land patterns, go to [www.maxim-ic.com/packages](http://www.maxim-ic.com/packages).

PACKAGE TYPE	PACKAGE CODE	DOCUMENT NO.
16 CSP	R162A2+1	<a href="#">21-0226</a>

Maxim cannot assume responsibility for use of any circuitry other than circuitry entirely embodied in a Maxim product. No circuit patent licenses are implied. Maxim reserves the right to change the circuitry and specifications without notice at any time.

Maxim Integrated Products, 120 San Gabriel Drive, Sunnyvale, CA 94086 408-737-7600 \_\_\_\_\_ 15