



Description

The SE5169 series of fixed output low dropout linear regulators are designed for portable battery powered applications, which require low power consumption and low dropout voltage. Each device contains a bandgap voltage reference, an error amplifier, a PMOS power transistor, and resistors for setting output voltage, and current limit and temperature limit protection circuits.

The SE5169 has been designed to be used with low cost capacitors and requires a minimum output capacitor of 1.0µF. The output voltages range from 1.3V to 4.4V in 100mV increments. Standard voltage versions are 1.5, 1.8, 2.5, 2.8, 3.0, and 3.3V.

Features

- Typical 110mV Dropout Voltage at 150mA.
- Excellent Line and Load Regulation.
- High Accuracy Output Voltage of 2%.
- Ultra-Low Ground Current at 35µA (Typ.)
- Over Current and thermal Protection.
- No Reverse Current.
- Available in SOT-23-3L and TO-92 Packages
- 100% Lead (Pb)-Free

Application

- USB removable devices
- MPEG4 devices
- Wireless LAN's
- Hand-Held Instrumentation.
- Portable DVD players
- Digital camera

Ordering/Marking Information

Package	Ordering Information		Marking Information	
<p>SOT-23-3L N-Pinout (Top View)</p>	3.3V	SE5169ALN-LF	169AN [●]	<p>Starting with 1, a bar on top of 1 is for production year 2001, and underlined 1 is for year 2002. The next character is marked on top for 2003, and underlined for 2004. The naming pattern continues with consecutive characters for later years.</p> <p>The last character is the week code. (A-Z: 1-26, a-z: 27-52)</p> <p>A dot on top right corner is for lead-free process.</p> <p>LF: lead free.</p>
	2.8V	SE5169BLN-LF	169BN [●]	
	2.5V	SE5169CLN-LF	169CN [●]	
	1.8V	SE5169DLN-LF	169DN [●]	
	1.5V	SE5169ELN-LF	169EN [●]	
	3.0V	SE5169FLN-LF	169FN [●]	
<p>SOT-23-3L G-Pinout (Top View)</p>	3.3V	SE5169ALG-LF	169AG [●]	
	2.8V	SE5169BLG-LF	169BG [●]	
	2.5V	SE5169CLG-LF	169CG [●]	
	1.8V	SE5169DLG-LF	169DG [●]	
	1.5V	SE5169ELG-LF	169EG [●]	
	3.0V	SE5169FLG-LF	169FG [●]	



Ordering/Marking Information (Continued)

Package	Ordering Information		Marking Information	
<p>TO-92 N-Pinout (Top View)</p>	3.3V	SE5169AHN-LF	SE5169AHN YYWW-LF	YY: year code WW: week code. LF: lead free.
	2.8V	SE5169BHN-LF	SE5169BHN YYWW-LF	
	2.5V	SE5169CHN-LF	SE5169CHN YYWW-LF	
	1.8V	SE5169DHN-LF	SE5169DHN YYWW-LF	
	1.5V	SE5169EHN-LF	SE5169EHN YYWW-LF	
	3.0V	SE5169FHN-LF	SE5169FHN YYWW-LF	
<p>TO-92 G-Pinout (Top View)</p>	3.3V	SE5169AHG-LF	SE5169AHG YYWW-LF	
	2.8V	SE5169BHG-LF	SE5169BHG YYWW-LF	
	2.5V	SE5169CHG-LF	SE5169CHG YYWW-LF	
	1.8V	SE5169DHG-LF	SE5169DHG YYWW-LF	
	1.5V	SE5169EHG-LF	SE5169EHG YYWW-LF	
	3.0V	SE5169FHG-LF	SE5169FHG YYWW-LF	



Absolute Maximum Ratings⁽¹⁾

Supply Input Voltage (VIN) +6V
 Power Dissipation (PD) Internally Limited ⁽³⁾
 Junction Temperature (TJ) 150°C
 Lead Temperature (soldering, 5 sec.) 260°C
 Storage Temperature (TS) -40°C to +150°C

Operating Ratings⁽²⁾

Supply Input Voltage (VIN) +2.0V to +5.5V
 Junction Temperature (TJ) 0°C to +125°C
 Package Thermal Resistance
 160°C/W (TO-92)
 250°C/W (SOT-23-3L)

Electrical Characteristics

V_{IN} = 5.0V; C_{IN} = 2.2µF; C_{OUT} = 2.2µF; I_{OUT} = 10mA; T_J = 25°C, unless otherwise specified.

Symbol	Parameter	Conditions	Min	Typ	Max	Units
V _{OUT}	Output Voltage Accuracy	SE5169-1.5V (V _{IN} =1.8V)	1.470	1.5	1.530	V
		SE5169-1.8V (V _{IN} =3.3V)	1.764	1.8	1.836	
		SE5169-2.5V	2.450	2.5	2.550	
		SE5169-2.8V	2.744	2.8	2.856	
		SE5169-3.0V	2.940	3.0	3.060	
		SE5169-3.3V	3.234	3.3	3.366	
ΔV _{OUT} / ΔT	Output Voltage Temperature Coefficient	Note 4	--	0.1	--	mV/°C
ΔV _{OUT} / V _{OUT}	Line Regulation	V _{IN} = (V _{OUT} + 0.8) V to 5.5V	--	0.2	--	%/V
ΔV _{OUT} / V _{OUT}	Load Regulation ⁽⁵⁾	V _{IN} = (V _{OUT} + 0.8V) or 2.5V I _{OUT} = 10mA to 300mA	--	1.0	--	%
V _{IN} - V _{OUT}	Dropout Voltage ⁽⁶⁾	I _{OUT} = 10mA	--	8	--	mV
		I _{OUT} = 150mA	--	110	--	
		I _{OUT} = 300mA	--	250	--	
T _{PROTECTION}	Thermal Protection	Thermal Protection Temperature	--	150	--	°C
		Protection Hysteresis	--	20	--	°C
PSRR	Ripple Rejection	f = 120Hz	--	61	--	dB
I _{GROUND}	Ground Current	I _{OUT} = 10mA	--	35	--	µA
I _{LIMIT}	Current Limit	V _{OUT} = 0V	--	500	--	mA



Note 1: Exceeding the absolute maximum rating may damage the device.

Note 2: The device is not guaranteed to function outside its operating rating.

Note 3: The maximum allowable power dissipation at any TA (ambient temperature) is calculated using: $P_{D(MAX)} = (T_{J(MAX)} - T_A)/\theta_{JA}$. Exceeding the maximum allowable power dissipation will result in excessive die temperature, and the regulator will go into thermal shutdown. See Table 1 and the "Thermal Considerations" section for details.

Note 4: Output voltage temperature coefficient is the worst-case voltage change divided by the total temperature range.

Note 5: Regulation is measured at constant junction temperature using low duty cycle pulse testing. Parts are tested for load regulation in the load range from 100µA to 300mA. Changes in output voltage due to heating effects are covered by the thermal regulation specification.

Note 6: Dropout voltage is defined as the input to output differential at which the output voltage drops 2% below its nominal value measured at 1V differential.

Typical Application

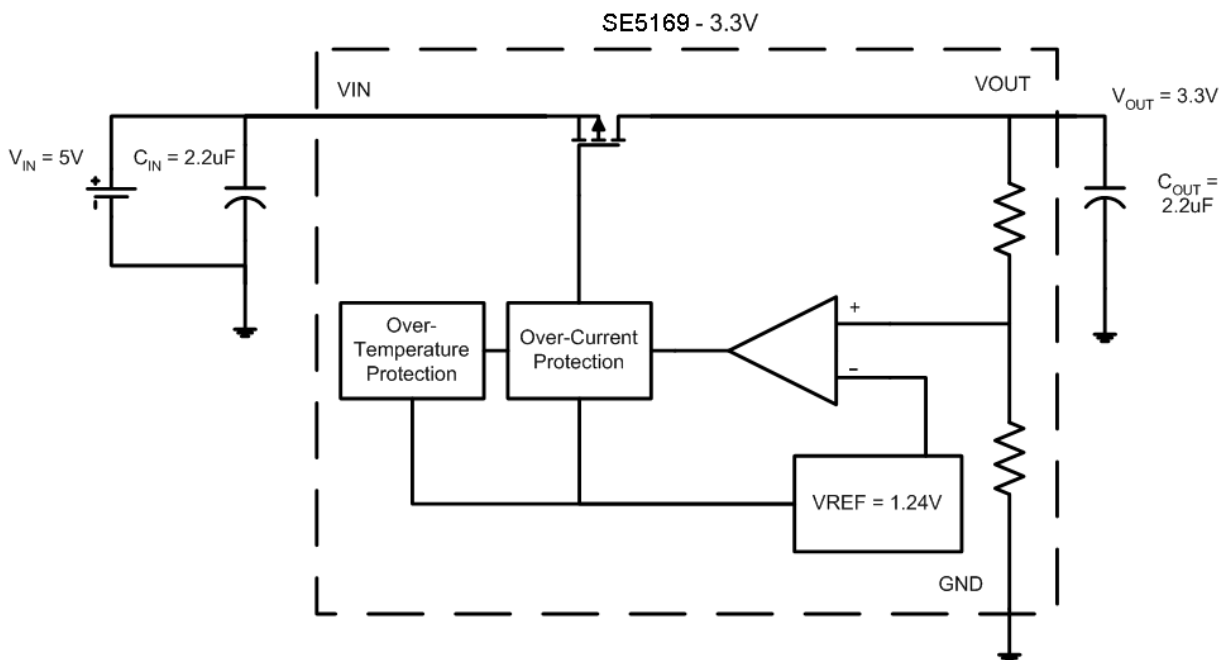

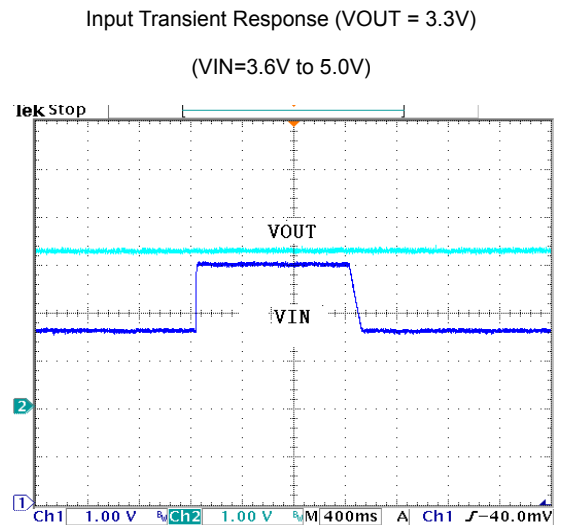
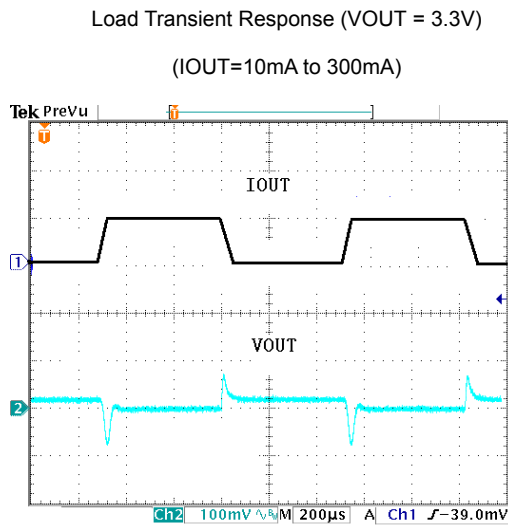
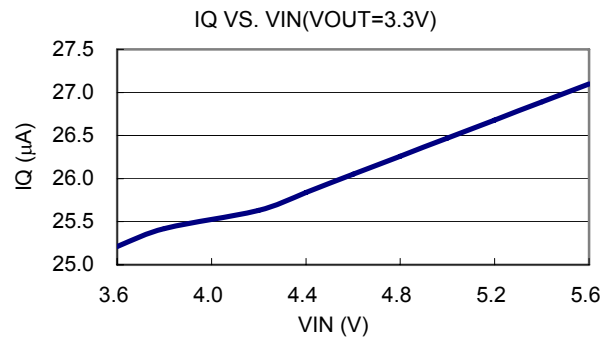
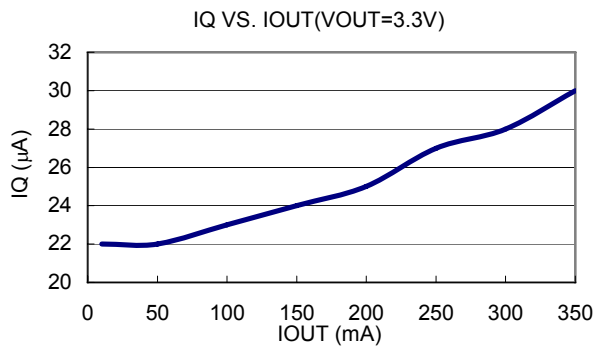
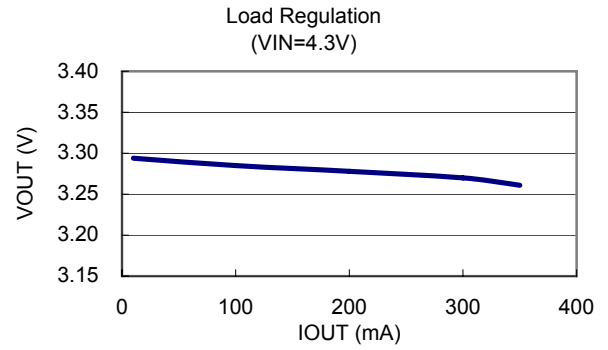
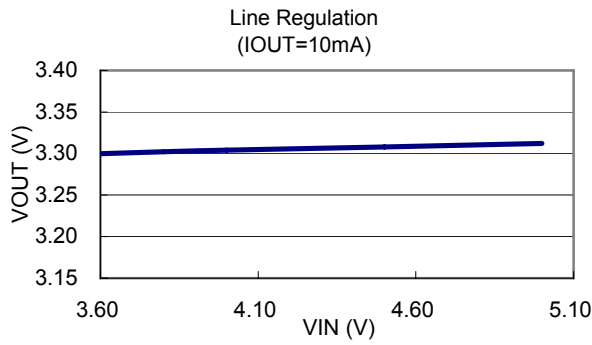

Application Hints

Like any low dropout regulator, SE5169 requires external capacitors to ensure stability. The external capacitors must be carefully selected to ensure performance.

Input Capacitor

An input capacitor of at least 1 μ F is required. Ceramic or Tantalum can be used. The value can be increased without upper limit.

Output Capacitor

An output capacitor is required for stability. It must be placed no more than 1 cm away from the V_{OUT} pin, and connected directly between V_{OUT} and GND pins. The minimum value is 1 μ F but may be increased without limit.

Thermal Considerations

It is important that the thermal limit of the package is not exceeded. The SE5169 has built-in thermal protection. When the thermal limit is exceeded, the IC will enter protection, and V_{OUT} will be pulled to ground. The power dissipation for a given application can be calculated as following:

The power dissipation (P_D) is

$$P_D = I_{OUT} * [V_{IN} - V_{OUT}]$$

The thermal limit of the package is then limited to $P_{D(MAX)} = [T_J - T_A]/\Theta_{JA}$ where T_J is the junction temperature, T_A is the ambient temperature, and Θ_{JA} is around 250°C/W for SE5169. SE5169 is designed to enter thermal protection at 150°C. For example, if T_A is 25°C then the maximum P_D is limited to about 0.5W. In other words, if $I_{OUT(MAX)} = 300mA$, then $[V_{IN} - V_{OUT}]$ cannot exceed 1.67V.



OUTLINE DRAWING SOT-23-3L

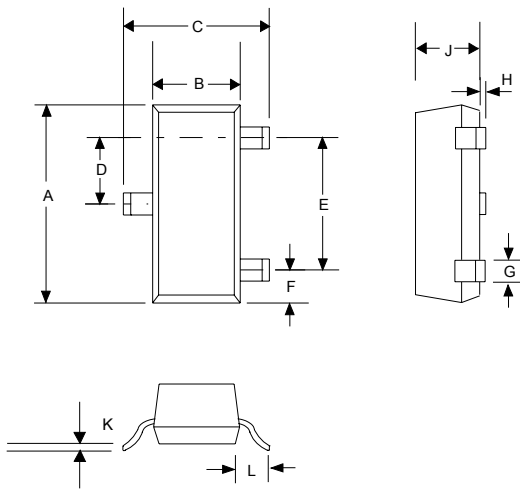

DIMENSIONS				
DIM ^N	INCHES		MM	
	MIN	MAX	MIN	MAX
A	0.110	0.120	2.80	3.04
B	0.047	0.055	1.20	1.40
C	0.083	0.104	2.10	2.64
D	0.035	0.040	0.89	1.03
E	0.070	0.080	1.78	2.05
F	0.018	0.024	0.45	0.60
G	0.015	0.020	0.37	0.51
H	0.0005	0.004	0.013	0.10
J	0.034	0.040	0.887	1.02
K	0.003	0.007	0.085	0.18
L	-	0.027	-	0.69

OUTLINE DRAWING TO-92

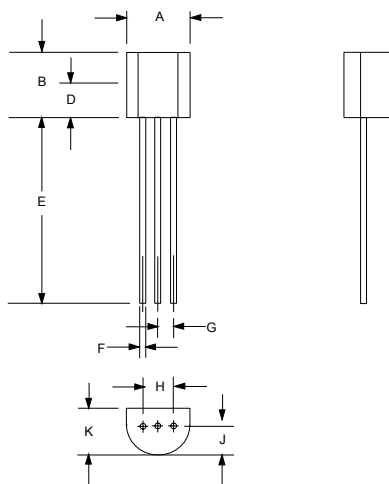

DIMENSIONS				
DIM ^N	INCHES		MM	
	MIN	MAX	MIN	MAX
A	0.175	0.205	4.445	5.207
B	0.170	0.210	4.318	5.334
E	0.500	0.610	12.70	15.50
F	0.016	0.021	0.407	0.533
G	0.045	0.055	1.143	1.397
H	0.095	0.105	2.413	2.667
J	0.080	0.105	2.032	2.667
K	0.125	0.165	3.175	4.191



Customer Support

Seaward Electronics Incorporated – China

Section B, 2nd Floor, ShangDi Scientific Office Complex, #22 XinXi Road

Haidian District, Beijing 100085, China

Tel: 86-10-8289-5700/01/05

Fax: 86-10-8289-5706

Seaward Electronics Corporation – Taiwan

2F, #181, Sec. 3, Minguan East Rd,

Taipei, Taiwan R.O.C

Tel: 886-2-2712-0307

Fax: 886-2-2712-0191

Seaward Electronics Incorporated – North America

1512 Centre Pointe Dr.

Milpitas, CA95035, USA

Tel: 1-408-821-6600

Last Updated - 12/4/2008