

AC-DC Open Frame

100-225 Watts CPL Series

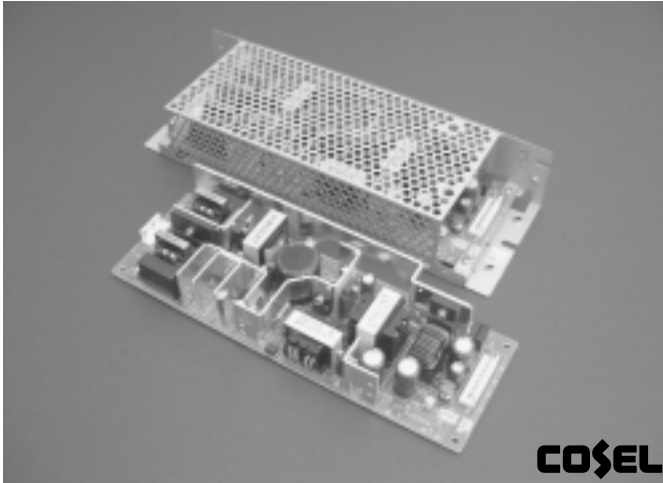

THE XPERTS IN POWER

- Isolated Outputs
- High Peak Current Ratings
- Compact PCB Construction
- Optional Remote On/Off
- Adjustable Output Voltage
- EN55022 Level B
- Cover, Connector & Loom Kits Available

Specification

Input

- Input Voltage** • 85-264 VAC (120-370 VDC)
- Input Frequency** • 47-63 Hz
- Inrush Current** • 15/30 A at 120/230 VAC in, 100% load & 25 °C
- Power Factor** • 0.99 typical at 100 VAC, 0.93 typical at 200 VAC & 100% load to IEC61000-3-2
- Earth Leakage Current** • 0.75 mA max at 230 VAC 60 Hz

Output

- Output Voltage** • See Tables
- Output Voltage Adjustment** • ±10% V1 only
- Minimum Load** • No minimum load required
- Start Up Time** • V1 250 ms, V2 500ms
- Hold Up Time** • V1 40 ms, V2 20 ms at 120 VAC
- Line Regulation** • 0.4% max over specified input range
- Load Regulation** • 0.8% max for a 100% load change
- Ripple & Noise** • 150 mV pk-pk max (0 °C to +50 °C)
- Overcurrent Protection** • >105% of rated current on V1 & >101% of peak current on V2 auto recovery
- Overvoltage Protection** • >115% of nominal value for V1 & 115-140% of nominal value for V2

General

- Efficiency** • 74-83% depending on specific model
- Isolation** • 3000 VAC Input to Output
2000 VAC Input to Ground
500 VAC Output to Ground
V1 to V2 100 VAC 1 min,
cut off current 100 mA,
100 VDC 10 MΩ min
- Switching Frequency** • 80-500 kHz

Options

- Designated by the following suffixes to the model number:
Reduce leakage current <0.1 mA '-G'
Remote ON/OFF '-R'
Cover fitted '-C'
Screw terminals '-T'
Add 4 outputs by the addition of a DC-DC converter to the board '-Z'
Contact Sales Office

Environmental

- Operating Temperature** • -10 °C to +70 °C (See Derating Curve)
- Storage Temperature** • -20 °C to +75 °C
- Humidity** • 20-90% RH, non condensing
- Shock** • 196.1 m/s² (20 G), 11 ms once each X, Y & Z axis
- Vibration** • 2 G 10-55 Hz, 3 axis

EMC & Safety

- Emissions** • EN55022 Level B conducted
EN55022 Level B radiated
- ESD Susceptibility** • EN61000-4-2 Level 2 contact
Level 3 air
- Radiated Susceptibility** • EN61000-4-3 Level 3
- EFT/Burst** • EN61000-4-4 Level 3
- Surge** • EN61000-4-5 Level 3 line to line
Level 4 line to ground
- Safety Approvals** • UL1950, C-UL, EN60950, VDE0160

OUTPUT VOLTAGE & CURRENT RATINGS - 100 WATT MODEL

CPL

Output Voltage	Current Rating		Regulation		Ripple & Noise pk-pk ⁽²⁾	Efficiency ⁽³⁾ Typical	Model Number
	Maximum	Peak ⁽¹⁾	Line	Load			
+5 V ₁	5.0 A	-	20 mV	40 mV	120 mV	80%	CPL100PD24
+24 V ₂	4.0 A	7 A	96 mV	150 mV	150 mV		
+5 V ₁	5.0 A	-	20 mV	40 mV	120 mV	76%	CPL100PD12
+12 V ₂	5.0 A	10 A	48 mV	100 mV	150 mV		

Notes

1. Peak rating for 10 sec with a duty cycle of 35% max.
2. Measured with 22µF cap within 150 mm of output terminal at 20 MHz bandwidth.
3. Measured at 200 VAC input & 100% load.

Mechanical Details - 100 Watt Models

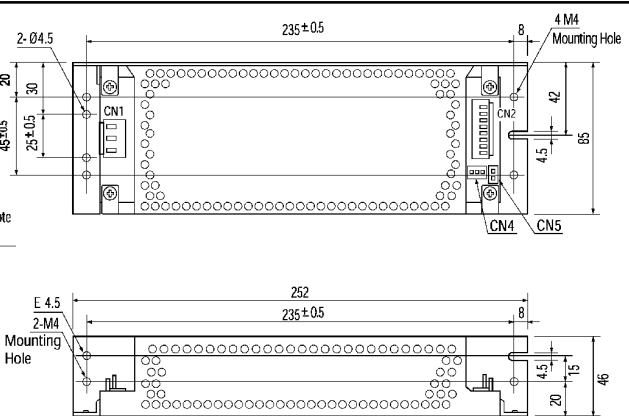
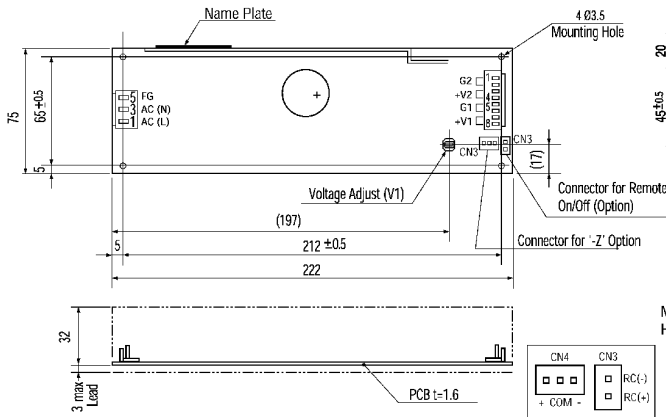

I/O Connector	Mating Connector	Terminal	
CN1	B3P5-VH	VHR-5N	Chain: SVH-21T-P1.1
			Loose: 8VH-21T-P1.1
CN2	B8P-VH	VHR-8N	Chain: SVH-21T-P1.1
			Loose: 8VH-21T-P1.1
CN3 (Option)	B2B-XH-A	XHP-2	Chain: SXH-001-P0.6
			Loose: BXH-001T-P0.6
CN4 (Option)	B3B-XH-A	XHP-3	Chain: SXH-001-P0.6
			Loose: BXH-001T-P0.6

CN1	
Pin No.	Input
1	AC(L)
2	-
3	AC(N)
4	-
5	FG

CN2	
Pin No.	Output
1, 2	G2
3, 4	V2
5, 6	G1
7, 8	V1

CN3 (Optional)	
Pin No.	Remote On/Off
1	RC(+)
2	RC(-)

CN4 (Optional)	
Pin No.	'-Z'
1	+
2	COM
3	-

NOTES:

- Weight 420g or less (without chassis & cover).
- Tolerance ±1.
- Dimensions in mm.
- PCB Material : CEM3.
- Optional chassis & cover, order part no. CPL100 COVER or add suffix '-C' to the model number to receive the unit with the cover fitted.
- Mounting torque 1.5N m (16 kgf cm) max.
- Keep drawing current per pin below 5 A (7 A @ pk load) for CN2.
- Optional connector kit available, order part no. CPL100/150 CON.
- Optional loom kit available, order part no. CPL100/150 LOOM.

Derating Curves - 100 Watt Models

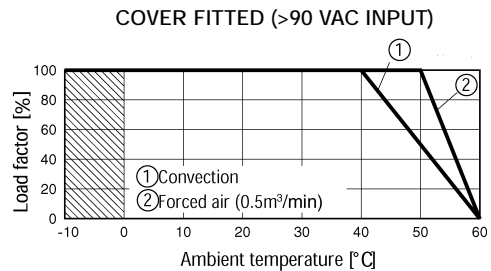
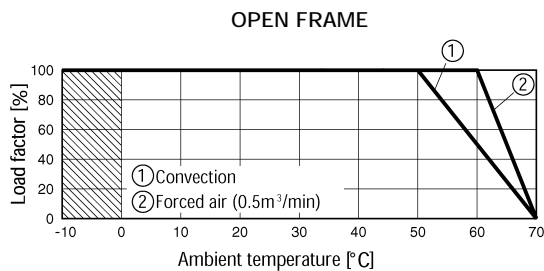

OUTPUT VOLTAGE & CURRENT RATINGS - 150 WATT MODEL

CPL

Output Voltage	Current Rating		Regulation		Ripple & Noise pk-pk ⁽²⁾	Efficiency ⁽³⁾ Typical	Model Number
	Maximum	Peak ⁽¹⁾	Line	Load			
+5 V ₁	5.0 A	-	20 mV	40 mV	120 mV	82%	CPL150PD24
+24 V ₂	6.0 A	10 A	96 mV	150 mV	150 mV		
+5 V ₁	5.0 A	-	20 mV	40 mV	120 mV	79%	CPL150PD12
+12 V ₂	7.5 A	14 A	48 mV	100 mV	150 mV		

Notes

1. Peak rating for 10 sec with a duty cycle of 35% max.
2. Measured with 22 μF cap within 150 mm of output terminal at 20 MHz bandwidth.
3. Measured at 200 V AC input & 100% load.

Mechanical Details - 150 Watt Models

I/O Connector	Mating Connector	Terminal	
CN1	B3P5-VH	VHR-5N	Chain: SVH-21T-P1.1
			Loose: 8VH-21T-P1.1
CN2	B8P-VH	VHR-8N	Chain: SVH-21T-P1.1
			Loose: 8VH-21T-P1.1
CN3 (Option)	B2B-XH-A	XHP-2	Chain: SXH-001-P0.6
CN4 (Option)	B3B-XH-A	XHP-3	Chain: SXH-001-P0.6
			Loose: BXH-001T-P0.6

CN1	
Pin No.	Input
1	AC(L)
2	-
3	AC(N)
4	-
5	FG

CN2	
Pin No.	Output
1, 2	G2
3, 4	V2
5, 6	G1
7, 8	V1

CN3 (Optional)	
Pin No.	Remote On/Off
1	RC(+)
2	RC(-)

CN4 (Optional)	
Pin No.	'-Z'
1	+
2	COM
3	-

NOTES:

- Weight 530g or less (without chassis & cover).
- Tolerance ±1.
- Dimensions in mm.
- PCB Material : CEM3.
- Optional chassis & cover, order part no. CPL150 COVER or add suffix '-C' to the model number to receive the unit with the cover fitted.
- Mounting torque 1.5N m (16 kgf cm) max.
- Ensure current per pin is below 5 A (7 A @ pk load) for CN2.
- Optional connector kit available, order part no. CPL100/150 CON.
- Optional loom kit available, order part no. CPL100/150 LOOM.

Derating Curves - 150 Watt Models

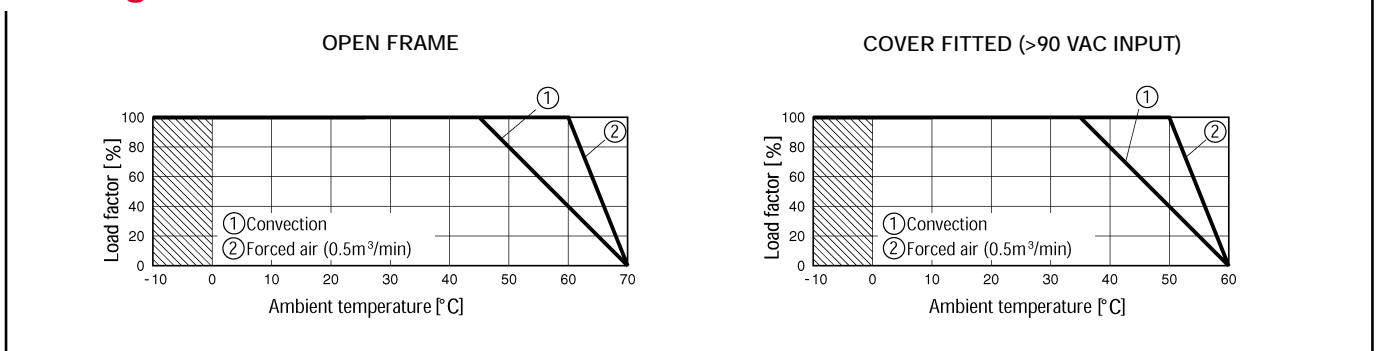

OUTPUT VOLTAGE & CURRENT RATINGS - 225 WATT MODEL

CPL

Output Voltage	Current Rating		Regulation		Ripple & Noise pk-pk ⁽²⁾	Efficiency ⁽³⁾ Typical	Model Number
	Maximum	Peak ⁽¹⁾	Line	Load			
+5 V ₁	5.0 A	-	20 mV	40 mV	120 mV	83%	CPL225PD24
+24 V ₂	9.0 A	14 A	96 mV	150 mV	150 mV		
+5 V ₁	5.0 A	-	20 mV	40 mV	120 mV	79%	CPL225PD12
+12 V ₂	10.0 A	20 A	48 mV	100 mV	150 mV		

Notes

1. Peak rating for 10 sec with a duty cycle of 35% max.
2. Measured with 22 μ F cap within 150 mm of output terminal at 20 MHz bandwidth.
3. Measured at 200 V AC input & 100% load.

Mechanical Details - 225 Watt Models

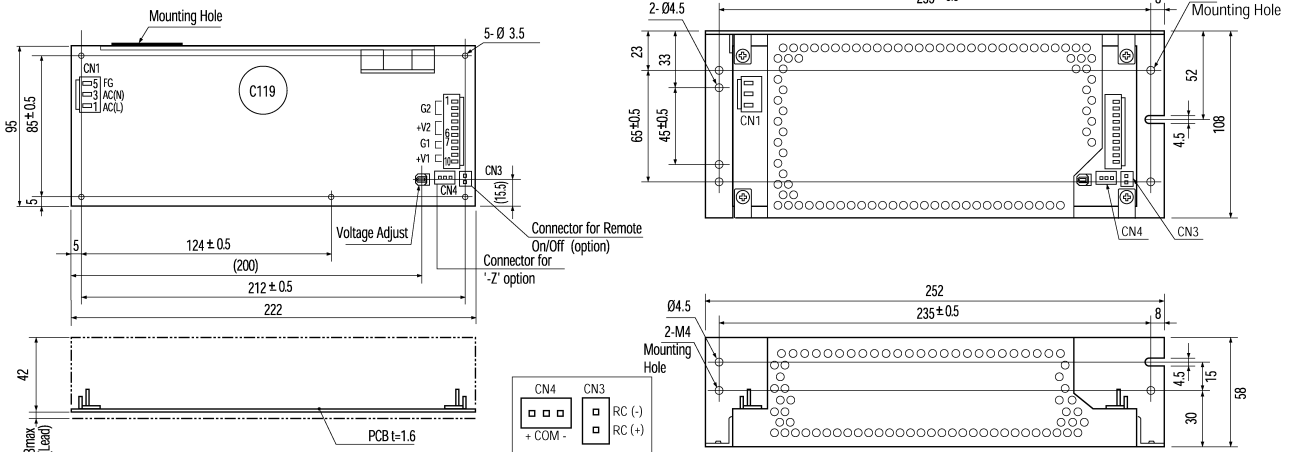

I/O Connector	Mating Connector	Terminal	
CN1	B3P5-VH	VHR-5N	Chain: SVH-21T-P1.1
			Loose: 8VH-21T-P1.1
CN2	B8P-VH	VHR-8N	Chain: SVH-21T-P1.1
			Loose: 8VH-21T-P1.1
CN3 (Option)	B2B-XH-A	XHP-2	Chain: SXH-001-P0.6
CN4 (Option)	B3B-XH-A	XHP-3	Chain: SXH-001-P0.6
			Loose: BXH-001T-P0.6

CN1	
Pin No.	Input
1	AC(L)
2	-
3	AC(N)
4	-
5	FG

CN2	
Pin No.	Output
1, 2, 3	G2
4, 5, 6	V2
7, 8	G1
9, 10	V1

CN3 (Optional)	
Pin No.	Remote On/Off
1	RC(+)
2	RC(-)

CN4 (Optional)	
Pin No.	'-Z'
1	+
2	COM
3	-

NOTES:

- Weight 700g or less (without chassis & cover).
- Tolerance ± 1 .
- Dimensions in mm.
- PCB Material : CEM3.
- Optional chassis & cover, order part no. CPL225 COVER or add suffix '-C' to the model number to receive the unit with the cover fitted.
- Mounting torque 1.5N m (16 kgf cm) max.
- Keep drawing current per pin below 5 A (7 A @ pk load) for CN2.
- Optional connector kit available, order part no. CPL225 CON.
- Optional loom kit available, order part no. CPL225 LOOM.

Derating Curves - 225 Watt Models

