



Dual N-Channel Enhancement Mode Field Effect Transistor

PRODUCT SUMMARY		
V _{DS}	I _D	R _{DS(ON)} (mΩ) Max
40V	6.8A	28 @ V _{GS} =10V
		46 @ V _{GS} =4.5V

FEATURES

- Super high dense cell design for low R_{DS(ON)}.
- Rugged and reliable.
- Surface Mount Package.

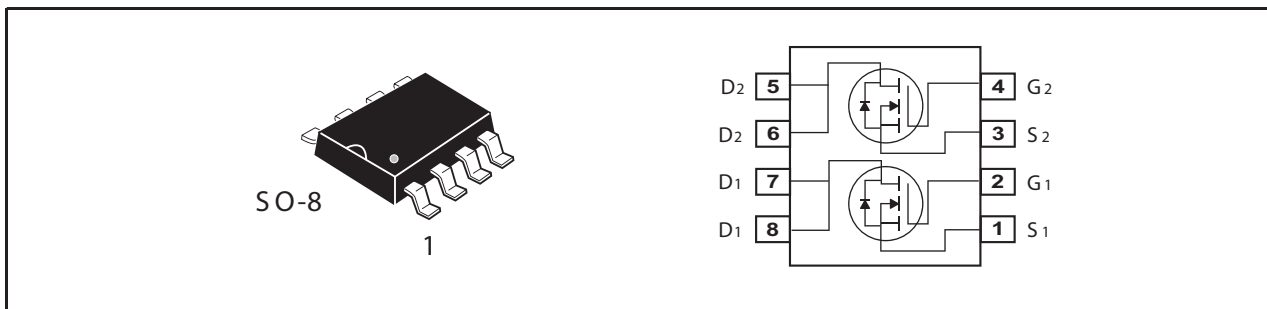

ABSOLUTE MAXIMUM RATINGS (T_A=25°C unless otherwise noted)

Symbol	Parameter	Limit	Units
V _{DS}	Drain-Source Voltage	40	V
V _{GS}	Gate-Source Voltage	±20	V
I _D	Drain Current-Continuous ^a	T _A =25°C	6.8
		T _A =70°C	5.4
I _{DM}	-Pulsed ^b	25	A
E _{AS}	Single Pulse Avalanche Energy ^d	18	mJ
P _D	Maximum Power Dissipation ^a	T _A =25°C	2
		T _A =70°C	1.28
T _J , T _{STG}	Operating Junction and Storage Temperature Range	-55 to 150	°C

THERMAL CHARACTERISTICS

R _{θJA}	Thermal Resistance, Junction-to-Ambient ^a	62.5	°C/W
------------------	--	------	------

STM6924

Ver 1.0

ELECTRICAL CHARACTERISTICS (TA=25°C unless otherwise noted)

Symbol	Parameter	Conditions	Min	Typ	Max	Units
OFF CHARACTERISTICS						
BV _{DSS}	Drain-Source Breakdown Voltage	V _{GS} =0V , I _D =250uA	40			V
I _{DSS}	Zero Gate Voltage Drain Current	V _{DS} =32V , V _{GS} =0V			1	uA
I _{GSS}	Gate-Body Leakage Current	V _{GS} = ±20V , V _{DS} =0V			±100	nA
ON CHARACTERISTICS						
V _{GS(th)}	Gate Threshold Voltage	V _{DS} =V _{GS} , I _D =250uA	1	1.8	3	V
R _{DS(ON)}	Drain-Source On-State Resistance	V _{GS} =10V , I _D =6.8A		23	28	m ohm
		V _{GS} =4.5V , I _D =5.3A		35	46	m ohm
g _{FS}	Forward Transconductance	V _{DS} =5V , I _D =6.8A		12		S
DYNAMIC CHARACTERISTICS ^c						
C _{ISS}	Input Capacitance	V _{DS} =20V, V _{GS} =0V f=1.0MHz		825		pF
C _{OSS}	Output Capacitance			80		pF
C _{RSS}	Reverse Transfer Capacitance			64		pF
SWITCHING CHARACTERISTICS ^c						
t _{D(ON)}	Turn-On Delay Time	V _{DD} =20V I _D =1A V _{GS} =10V R _{GEN} =3.3ohm		15.5		ns
t _r	Rise Time			13.5		ns
t _{D(OFF)}	Turn-Off Delay Time			17		ns
t _f	Fall Time			18		ns
Q _g	Total Gate Charge	V _{DS} =20V, I _D =6.8A, V _{GS} =10V		13		nC
		V _{DS} =20V, I _D =6.8A, V _{GS} =4.5V		6.5		nC
Q _{gs}	Gate-Source Charge	V _{DS} =20V, I _D =6.8A, V _{GS} =4.5V		2		nC
Q _{gd}	Gate-Drain Charge			3.6		nC
DRAIN-SOURCE DIODE CHARACTERISTICS AND MAXIMUM RATINGS						
I _S	Maximum Continuous Drain-Source Diode Forward Current				1.7	A
V _{SD}	Diode Forward Voltage ^b	V _{GS} =0V, I _S =1.7A		0.78	1.3	V
Notes a. Surface Mounted on FR4 Board, t ≤ 10sec. b. Pulse Test: Pulse Width ≤ 300us, Duty Cycle ≤ 2%. c. Guaranteed by design, not subject to production testing. d. Starting T _J =25°C, L=0.5mH, V _{DD} = 20V, V _{GS} =10V. (See Figure13)						

Nov,07,2008

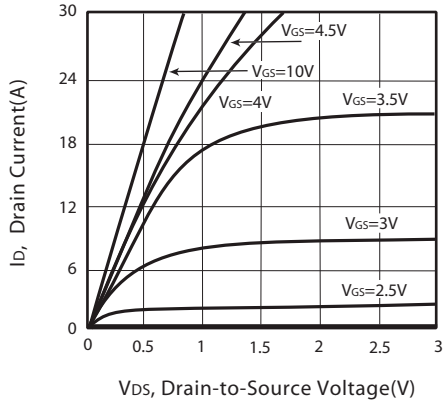

Figure 1. Output Characteristics

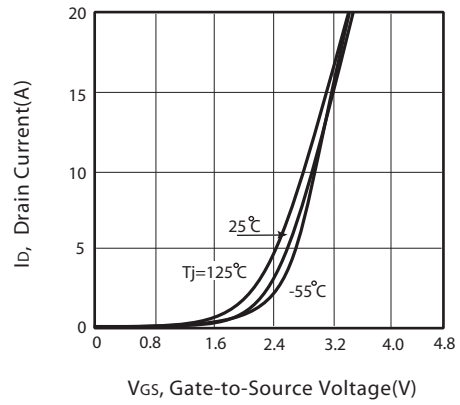

Figure 2. Transfer Characteristics

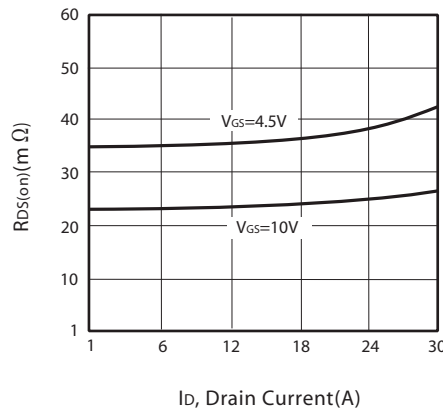

Figure 3. On-Resistance vs. Drain Current and Gate Voltage

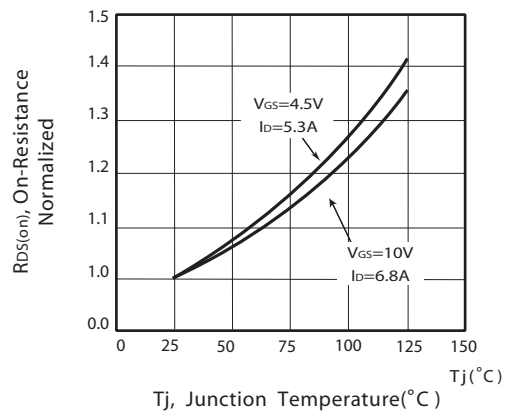

Figure 4. On-Resistance Variation with Drain Current and Temperature

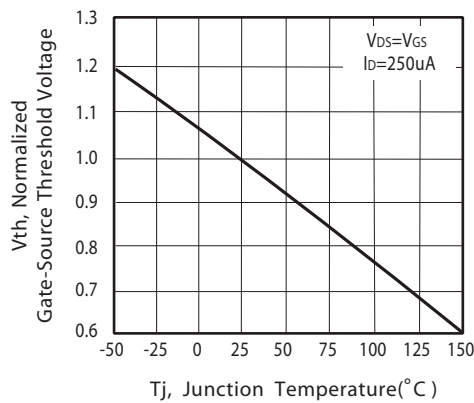

Figure 5. Gate Threshold Variation with Temperature

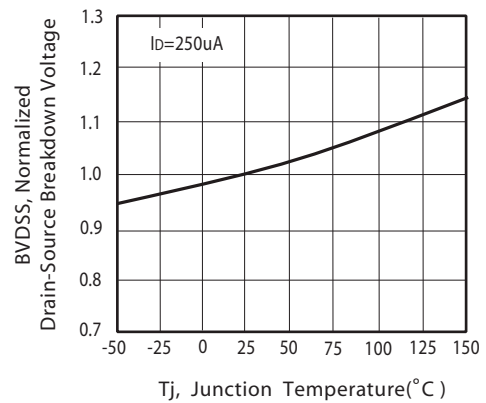

Figure 6. Breakdown Voltage Variation with Temperature

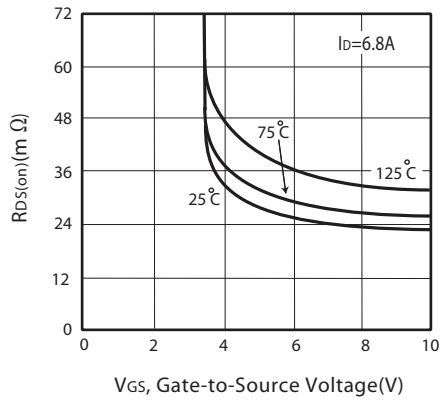

Figure 7. On-Resistance vs. Gate-Source Voltage

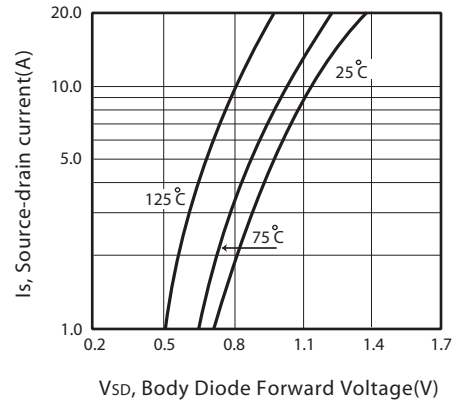

Figure 8. Body Diode Forward Voltage Variation with Source Current

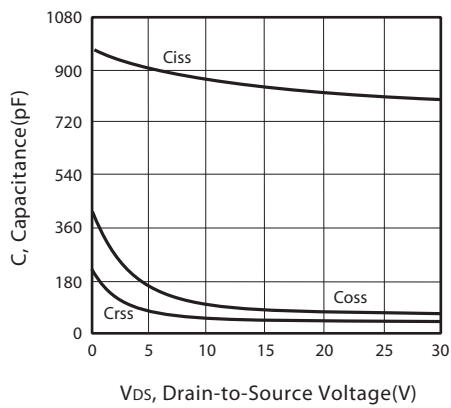

Figure 9. Capacitance

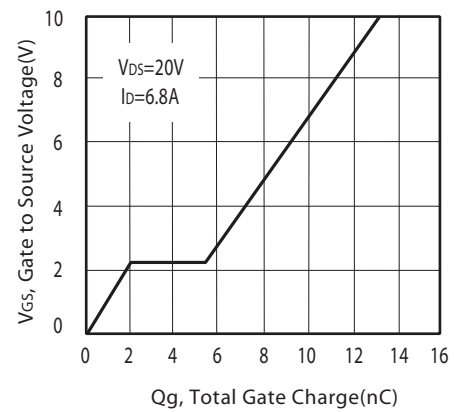

Figure 10. Gate Charge

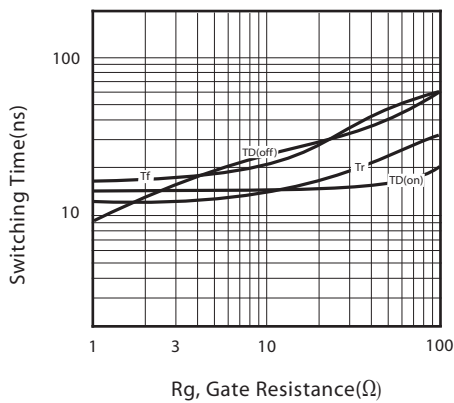

Figure 11. switching characteristics

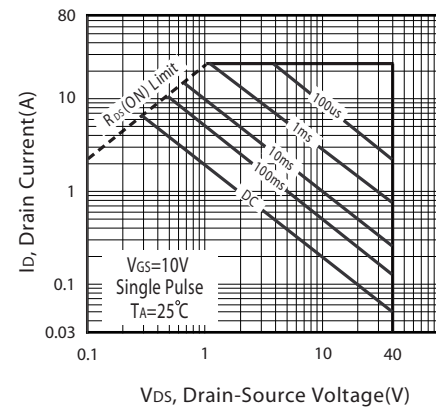
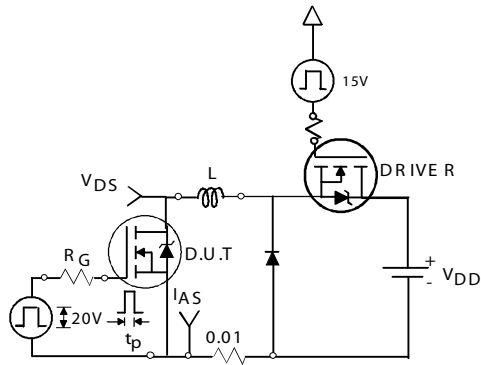
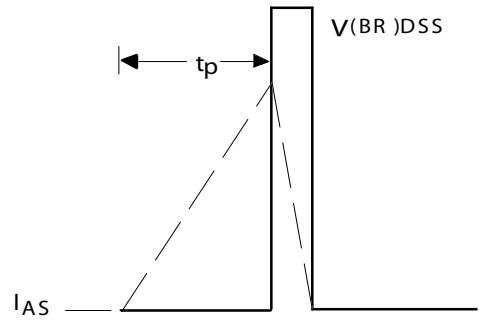

Figure 12. Maximum Safe Operating Area



Unclamped Inductive Test Circuit

Figure 13a.



Unclamped Inductive Waveforms

Figure 13b.

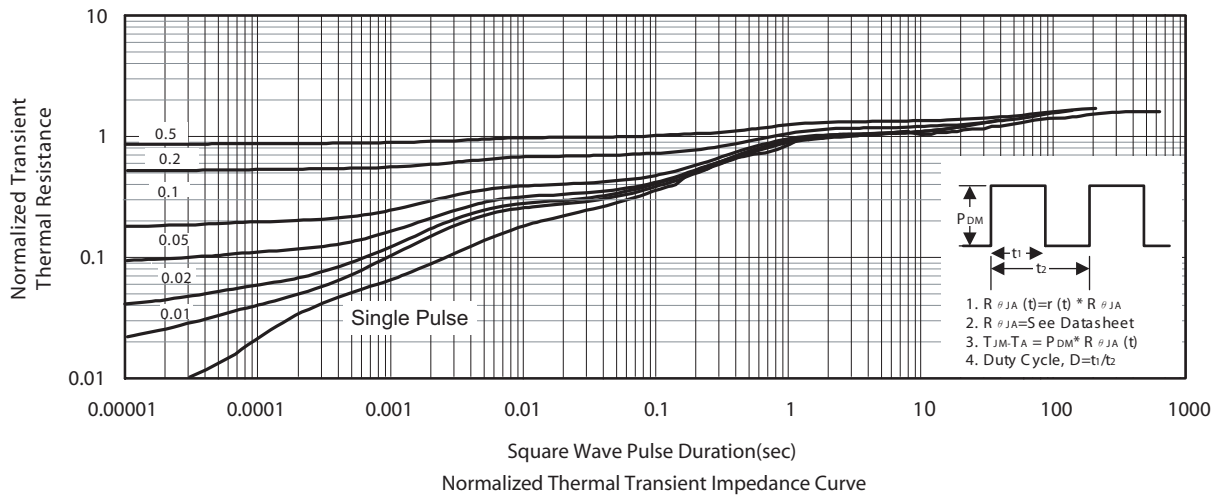

PACKAGE OUTLINE DIMENSIONS

SO-8

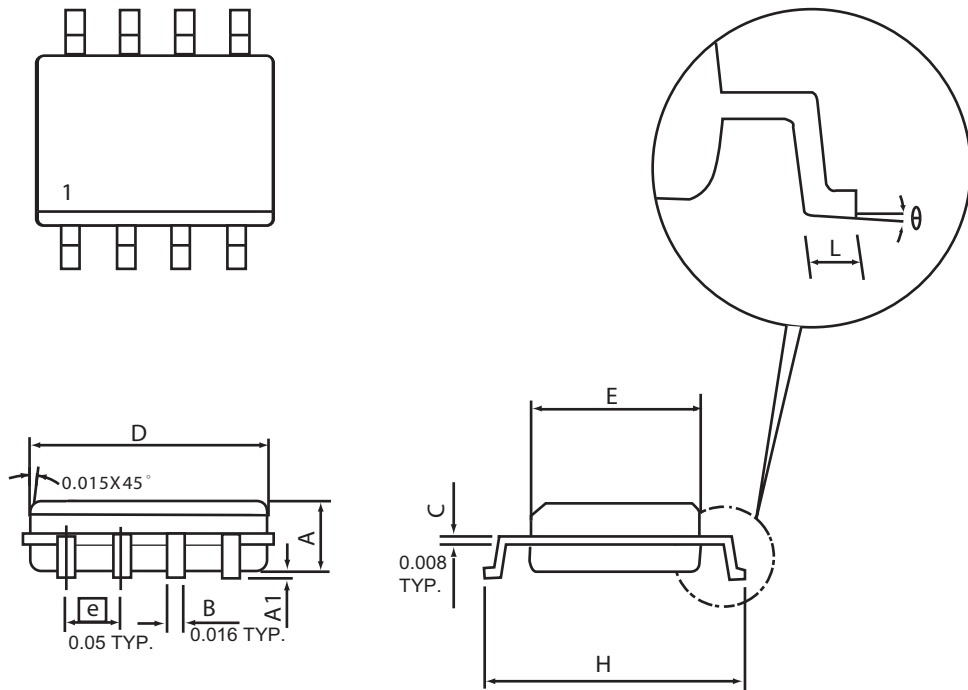

SYMBOLS	MILLIMETERS		INCHES	
	MIN	MAX	MIN	MAX
A	1.35	1.75	0.053	0.069
A1	0.10	0.25	0.004	0.010
D	4.80	4.98	0.189	0.196
E	3.81	3.99	0.150	0.157
H	5.79	6.20	0.228	0.244
L	0.41	1.27	0.016	0.050
θ	0°	8°	0°	8°

Notes : SO-8 package weight : 0.083g

SO-8 Tape and Reel Data

SO-8 Carrier Tape

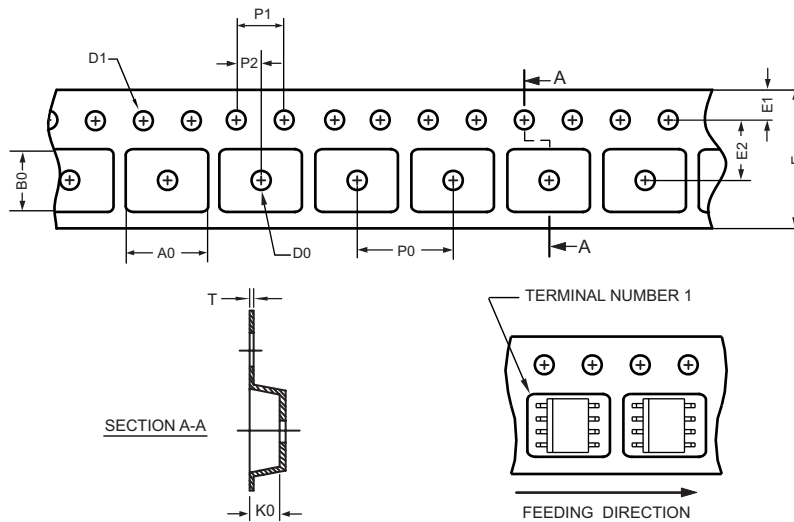

unit: mm

PACKAGE	A0	B0	K0	D0	D1	E	E1	E2	P0	P1	P2	T
SOP 8N 150mil	6.50 ±0.15	5.25 ±0.10	2.10 ±0.10	φ 1.5 (MIN)	φ 1.55 ±0.10	12.0 +0.3 -0.1	1.75 ±0.10	5.5 ±0.10	8.0 ±0.10	4.0 ±0.10	2.0 ±0.10	0.30 ±0.013

SO-8 Reel

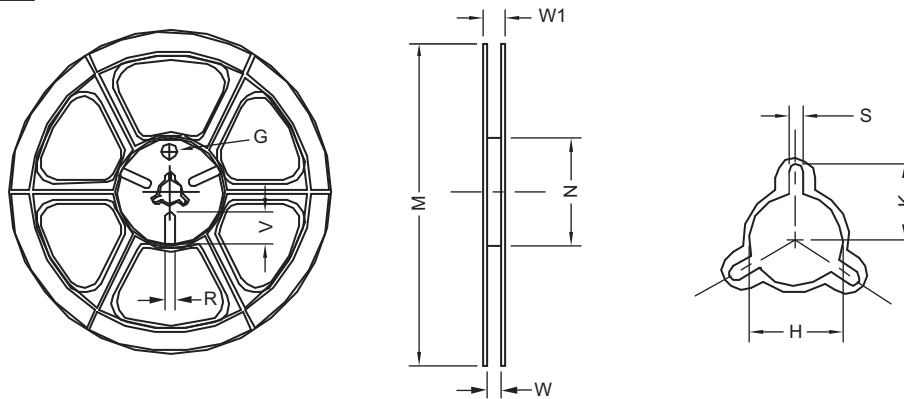

UNIT: mm

TAPE SIZE	REEL SIZE	M	N	W	W1	H	K	S	G	R	V
12 mm	φ 330	330 ± 1	62 ±1.5	12.4 + 0.2	16.8 - 0.4	φ 12.75 + 0.15	---	2.0 ±0.15	---	---	---