

FEATURES

- 2.5% EVM @ $P_{OUT} = +19$ dBm with IEEE 802.11g 64 QAM OFDM at 54 Mbps
- -34 dBr 1st Sidelobe / -56 dBr 2nd Sidelobe ACPR at +21 dBm with IEEE 802.11b at 1, 2, 5.5, 11 Mbps, Gaussian baseband filtering
- SP3T RF Switch to Enable Bluetooth Path
- Single +3.8 V Supply
- Transmit Path Linear Power of Gain 24 dB
- Receive Path In-Band Gain of 13 dB
- Receive Path Noise Figure of 1.9 dB
- 3 x 3 x 0.55 mm ULPCC Package
- Leadfree and RoHS Compliant

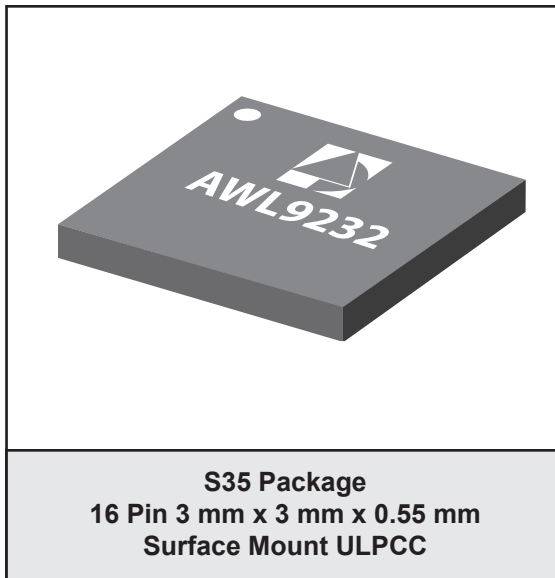
APPLICATIONS

- 802.11b/g WLAN in Consumer Electronics Products (e.g., cell phones, MP3 players, cameras, etc.)
- 2.4 GHz Cordless Phone Handsets/Basestations

PRODUCT DESCRIPTION

The ANADIGICS AWL9232 is a high performance InGaP HBT power amplifier, low-noise amplifier and RF switch integrated on a single IC. It is particularly applicable in consumer electronics products (e.g., cell phones, MP3 players, cameras, etc.) that integrate 802.11b/g WLAN in the 2.4 - 2.5 GHz band. Matched to 50Ω on all RF ports, the part requires only one choke inductor and one power supply decoupling cap off-chip.

The antenna port is switched between WLAN transmit, WLAN receive and Bluetooth paths with a low-loss single-pole triple-throw RF switch. The transmit path PA exhibits unparalleled linearity for both IEEE 802.11g and 802.11b WLAN systems under the toughest signal configurations within these standards. The WLAN receive path from the antenna port to receiver output port provides a low noise, high-gain path to the system receiver chain. The AWL9232 is biased by a single +3.8 V supply and consumes ultra-low current in the OFF mode.



The AWL9232 is manufactured using advanced InGaP HBT technology that offers state-of-the-art reliability, temperature stability and ruggedness. It is provided in a 3 x 3 x 0.55 mm ULPCC package optimized for a 50Ω system.

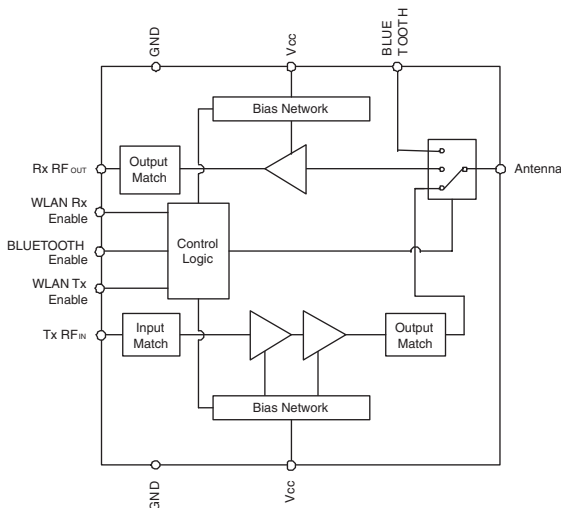

Figure 1: Block Diagram and Pinout

Table 1: Pin Description

PIN	NAME	DESCRIPTION
1	BLUETOOTH	Bluetooth RF Port
2	GND	Ground
3	RX_RF	Receive RF Port
4	GND	Ground
5	LNA_EN	LNA Enable. On/Off control for the Rx Path low noise amplifier
6	BT_EN	Bluetooth Enable. On/Off control for the Bluetooth path
7	PA_EN	Power Amplifier Enable. On/Off control for the the Tx path power amplifier
8	GND	Ground
9	PA_IN	Power Amplifier Input
10	GND	Ground
11	V _{CC1}	Power Supply. Bias for the 1st and 2nd stage transistors.
12	V _{CC2}	Power Supply. Bias for the 3rd stage transistors.
13	N/C	No connect.
14	GND	Ground
15	ANT	Antenna Port. Common connection for the PA, LNA and Bluetooth paths.
16	GND	Ground

Table 2: Absolute Minimum and Maximum Ratings

PARAMETER	MIN	MAX	UNIT	COMMENTS
DC Power Supply Voltage (V_{CC})	-	+5.0	V	No RF signal applied
DC Power Control Voltage (V_{PA_EN})	-	+5.0	V	No RF signal applied
DC Power Control Voltage (V_{LNA_EN})	-	+5.0	V	No RF signal applied
DC Power Control Voltage (V_{BT_EN})	-	+5.0	V	No RF signal applied
DC Current Consumption	-	350	mA	
Tx RF Input Level (RF_{IN})	-	5	dBm	
Ant RF Input Level (RF_{IN})	-	-3	dBm	
Bluetooth RF Input Level (RF_{IN})	-	30	dBm	
Storage Case Temperature	-55	+150	°C	
Operating Case Temperature	-40	+85	°C	
ESD Tolerance	300	-	V_{DC}	All pins, forward and reverse voltage. Human Body Model (HBM)
MSL Rating	-	MSL-2		
Reflow Temperature	-	260	°C	

Stresses in excess of the absolute ratings may cause permanent damage. Functional operation is not implied under these conditions. Exposure to absolute ratings for extended periods of time may adversely affect reliability.

Table 3: Operating Ranges

PARAMETER	MIN	TYP	MAX	UNIT	COMMENTS
Operating Frequency (f)	2400	-	2500	MHz	
DC Power Supply Voltage (V _{CC})	+3.0	+3.8	+4.2	V	
Control Voltage (V _{PA_EN})	2.0 0	- -	V _{CC} +0.4	V	PA "ON" PA "SHUTDOWN"
Control Voltage (V _{BT_EN})	2.0 0	- -	V _{CC} +0.4	V	BT "ON" BT "SHUTDOWN"
Control Voltage (V _{LNA_EN})	2.0 0	- -	V _{CC} +0.4	V	LNA "ON" LNA "SHUTDOWN"
Control Current (V _{PA_EN})	- -	3 -	25 1	μA	PA "ON" PA "SHUTDOWN"
Control Current (V _{BT_EN})	- -	3 -	25 1	μA	BT "ON" BT "SHUTDOWN"
Control Current (V _{LNA_EN})	- -	1 -	5 1	mA μA	LNA "ON" LNA "SHUTDOWN"
Case Temperature (T _C)	-40	-	+85	°C	

The device may be operated safely over these conditions; however, parametric performance is guaranteed only over the conditions defined in the electrical specifications.

ELECTRICAL CHARACTERISTICS

Table 4: Electrical Specifications - Tx Path Continuous Wave and DC Electrical Specification
 (T_C = +25 °C, V_{CC} = +3.8 V, V_{PA_EN} = +3.1 V, V_{LNA_EN} = 0 V, V_{BT_EN} = 0 V)

PARAMETER	MIN	TYP	MAX	UNIT	COMMENTS
Shutdown Current	-	20	90	μA	Tx Mode (V _{CC} = +3.8 V, V _{BT_EN} = V _{PA_EN} = V _{LNA_EN} = 0 V)
Quiescent Current	20	50	80	mA	V _{CC} = +3.8 V, V _{LNA_EN} = 0 V, V _{BT_EN} = 0 V, V _{PA_EN} = 3.1 V, RF = off
2 nd Harmonic (2fo)	-	-30	-15	dBm	P _{OUT} = +21 dBm ⁽¹⁾
3 rd Harmonic (3fo)	-	-20	-10	dBm	P _{OUT} = +21 dBm ⁽¹⁾
Input Return Loss, TX RF In	-	-10	-4	dB	
Output Return Loss, Antenna Port, Switch in Transit Mode	-	-6	-4	dB	Switch in TX position
Reverse Isolation (Antenna port to TX Input Port)	20	45	-	dB	Switch in TX position, signal injected into Antenna Port and measured at TX input Port, PA = "ON"
Stability	-	-65	-	dBc	6:1 VSWR, P _{OUT} = +21 dBm ⁽¹⁾ , -40 °C
T _{ON} Rise Time	-	-	2	μs	10% to 90% of maximum RF power. P _{OUT} = +19 dBm ⁽¹⁾

Notes:

(1) Power as measured at antenna port of AWL9232.

Table 5: Electrical Specifications - Tx Path 802.11g(T_C = +25 °C, V_{CC} = +3.8 V, V_{PA_EN} = +3.1 V, V_{LNA_EN} = 0 V, V_{BT_EN} = 0 V, 64 QAM OFDM 54 Mbps)

PARAMETER	MIN	TYP	MAX	UNIT	COMMENTS
Operating Frequency	2400	-	2500	MHz	
Power Gain	21	25	29	dB	
Gain Ripple	-	± 1.0	± 2.5	dB	Across 100 MHz band
Error Vector Magnitude (EVM) ⁽²⁾	-	2.5	4.0	%	P _{OUT} = +19 dBm ⁽¹⁾
	-	-32.0	-28.0	dB	
Current Consumption	110	145	180	mA	P _{OUT} = +19 dBm ⁽¹⁾
TX Spectrum Mask	Pass	-	-	N/A	P _{OUT} = +19 dBm ⁽¹⁾

Notes:

(1) Power as measured at antenna port of AWL9232.

(2) EVM does not include system noise floor of 1% (-40 dB).

Table 6: Electrical Specifications - Tx Path 802.11b(T_C = +25 °C, V_{CC} = +3.8 V, V_{PA_EN} = +3.1 V, V_{LNA_EN} = 0 V, V_{BT_EN} = 0 V, 1 Mbps CCK/DSSS, Gaussian Baseband Filtering, bT = 0.50)

PARAMETER	MIN	TYP	MAX	UNIT	COMMENTS
Operating Frequency	2400	-	2500	MHz	
Power Gain	21	25	29	dB	
Gain Ripple	-	± 1.0	± 2.5	dB	Across any 100 MHz band
Adjacent Channel Power (ACPR) 1 st Sidelobe (11-22 MHz Offset)	-	-34	-30	dBr	P _{OUT} = +21 dBm ⁽¹⁾
Adjacent Channel Power (ACPR) 2 nd Sidelobe (>22 MHz Offset)	-	-56	-50	dBr	P _{OUT} = +21 dBm ⁽¹⁾
Tx Spectrum Mask	Pass	-	-	N/A	P _{OUT} = +21 dBm ⁽¹⁾
Current Consumption	130	175	220	mA	P _{OUT} = +21 dBm ⁽¹⁾

Notes:

(1) Power as measured at antenna port of AWL9232.

Table 7: Electrical Specifications - Rx Path Continuous Wave
 (T_C = +25 °C, V_{CC} = +3.8 V, V_{PA_EN} = 0 V, V_{LNA_EN} = +3.1 V, V_{BT_EN} = 0 V)

PARAMETER	MIN	TYP	MAX	UNIT	COMMENTS
Gain	10	13	16	dB	
Gain Ripple	-	±0.5	±2.0	dB	Across any 100 MHz band
IP1dB	-12	-7	-	dBm	
Current at IP1dB	9	14	19	mA	
Quiescent Current	9	14	19	mA	
Noise Figure	-	1.9	4.0	dB	Includes RF switch and LNA
Return Loss, RX RF Port	-	-15	-6	dB	Switch in Rx position, Antenna port terminated in 50 Ω Load
Return Loss, Antenna Port, Switch in Receive Mode	-	-5	-3	dB	Switch in RX position, with 50Ω Rx path load
Isolation (Antenna port to RX port)	20	50	-	dB	Switch in TX position, signal injected into Antenna Port and measured at Rx Port, PA = "ON"
Stability	-	-65	-	dBc	6:1 VSWR, P _{IN} = -7 dBm ⁽¹⁾ , -40°C

Note:

(1) Power as measured at antenna port of AWL9232.

Table 8: Electrical Specifications - BT Path Continuous Wave
 (T_C = +25 °C, V_{CC} = +3.8 V, V_{PA_EN} = 0 V, V_{LNA_EN} = 0 V, V_{BT_EN} = +3.1 V)

PARAMETER	MIN	TYP	MAX	UNIT	COMMENTS
Insertion Loss	-	0.7	2.0	dB	2.4 GHz to 2.5 GHz
Quiescent Current	-	20	100	μA	
OP1dB	21	27	-	dBm	Measured at Ant port
Return Loss, Bluetooth RF Port	-	-12	-6	dB	Switch in Bluetooth position, Antenna port terminated in 50 Ω load
Return Loss, Antenna Port, Switch in Bluetooth Mode	-	-11	-6	dB	Switch in Bluetooth position, Bluetooth port terminated in 50 Ω load
Isolation (Antenna port to RX port)	15	33	-	dB	Switch in Bluetooth position, signal injected into Antenna Port and measured at Rx Port

Table 9: Control Logic Truth Table

FEIC Mode	V _{CC}	PA Enable	Bluetooth Enable	LNA Enable	PA Status	LNA Status	Switch Status
Shutdown	On	0	0	0	Off	Off	Not connected
WLAN Rx	On	0	0	1	Off	On	WLAN Rx
Bluetooth	On	0	1	0	Off	Off	Bluetooth
WLAN Tx	On	1	0	0	On	Off	WLAN Tx

Table 10: Control Voltages and Timing

Parameter	Min	Typ	Max	Unit	Comments
LNA Enable Pin Control Voltage	2.0 -	- -	V _{CC} +0.4	V	LNA = 1 LNA = 0
Bluetooth Enable Pin Control Voltage	2.0 -	- -	V _{CC} +0.4	V	Bluetooth = 1 Bluetooth = 0
PA Enable Pin Control Voltage	2.0 -	- -	V _{CC} +0.4	V	PA = 1 PA = 0

PERFORMANCE DATA - TRANSMIT PATH

Figure 2: Tx Path Gain and Icc vs. Output Power Across Freq (V_{CC} = +3.8 V, T_A = +25°C) 802.11g 54 Mbps OFDM

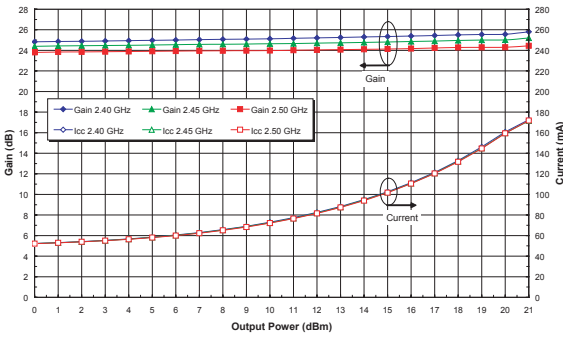


Figure 3: Tx Path Gain and Icc vs. Output Power Across Temp (Freq = 2.45 GHz, V_{CC} = +3.8 V) 802.11g 54 Mbps OFDM

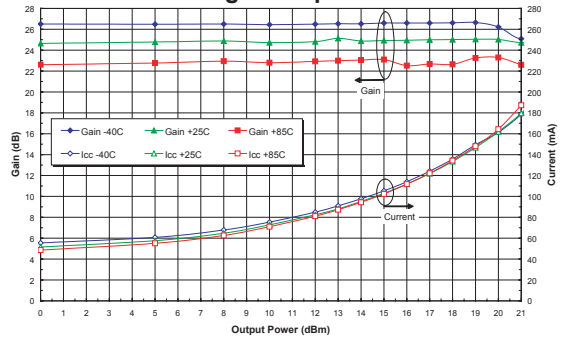


Figure 4: Tx Path Gain and Icc vs. Output Power Across Supply Voltage (Freq = 2.45 GHz, T_A = +25°C) 802.11g 54 Mbps OFDM

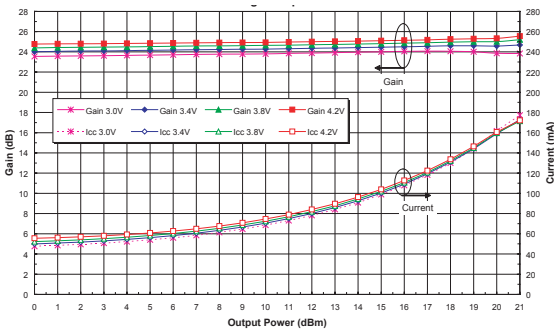


Figure 5: Tx Path EVM vs. Output Power Across Frequency (V_{CC} = +3.8 V, T_A = +25°C) 802.11g 54 Mbps OFDM

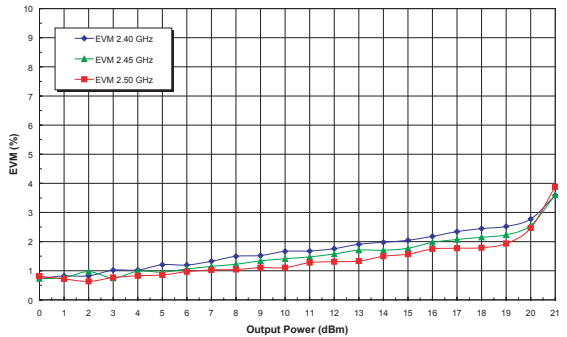


Figure 6: Tx Path EVM vs. Output Power Across Temp (Freq = 2.45 GHz, V_{CC} = +3.8 V) 802.11g 54 Mbps OFDM

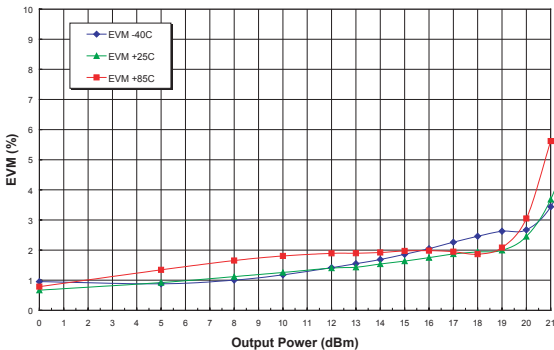


Figure 7: Tx Path EVM vs. Output Power Across Power Supply Voltage (Freq = 2.45 GHz, T_A = +25°C) 802.11g 54 Mbps OFDM

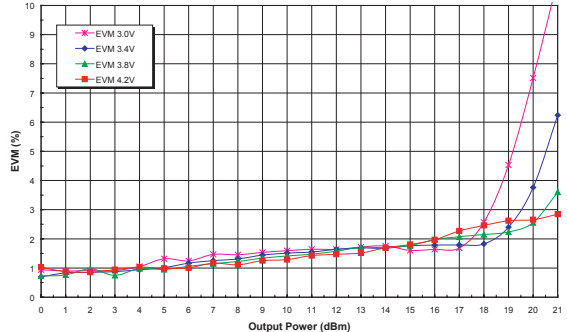


Figure 8: Tx Path Gain and Icc vs. Output Power Across Freq ($V_{CC} = +3.8\text{ V}$, $T_A = +25^\circ\text{C}$) 802.11b Gaussian Filtering ($bT = 0.5$), 1 Mbps

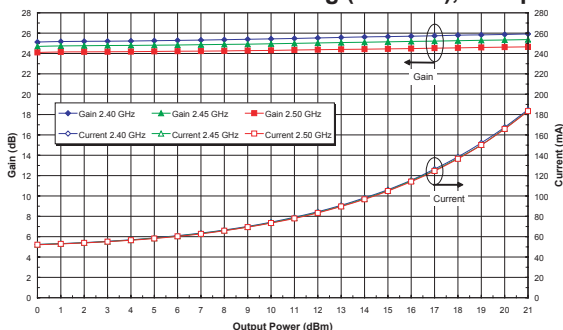


Figure 9: Tx Path Gain and Icc vs. Output Power Across Temp (Freq = 2.45 GHz, $V_{CC} = +3.8\text{ V}$) 802.11b Gaussian Filtering ($bT = 0.5$), 1 Mbps

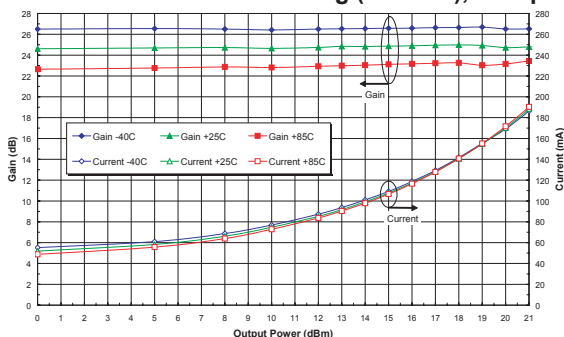


Figure 10: Tx Path Gain and Icc vs. Output Power Across Supply Voltage (Freq = 2.45 GHz, $T_A = +25^\circ\text{C}$) 802.11b Gaussian Filtering ($bT = 0.5$), 1 Mbps

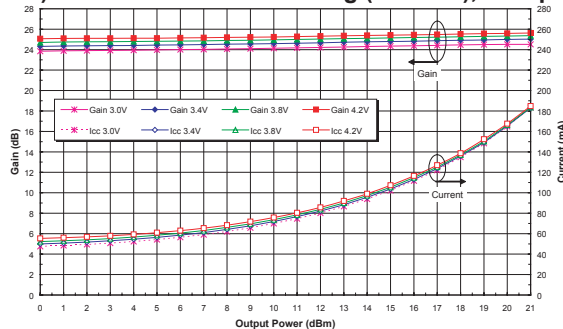


Figure 11: Tx Path ACPR Sidelobes 1&2 vs. Output Power Across Freq ($V_{CC} = +3.8\text{ V}$, $T_A = +25^\circ\text{C}$) 802.11b Gaussian Filtering ($bT = 0.5$), 1 Mbps

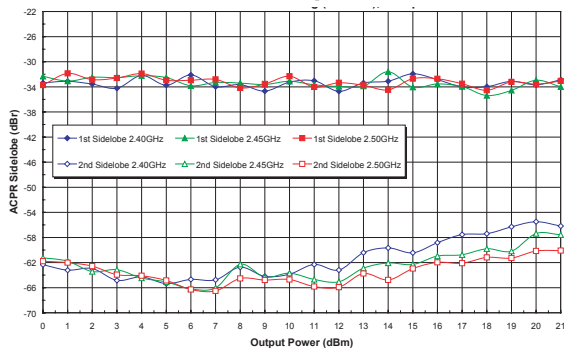


Figure 12: Tx Path ACPR Sidelobes 1&2 vs. Output Power Across Temp (Freq = 2.45 GHz, $V_{CC} = +3.8\text{ V}$) 802.11b Root Cosine Filtering ($bT = 0.5$), 1 Mbps

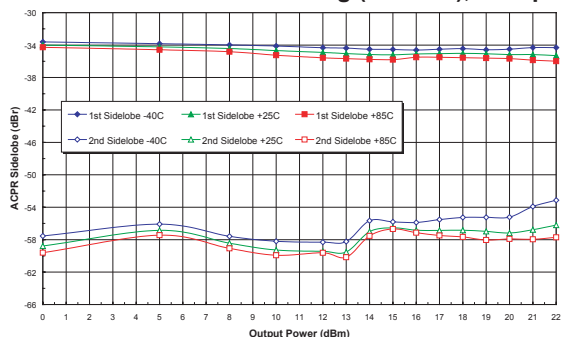
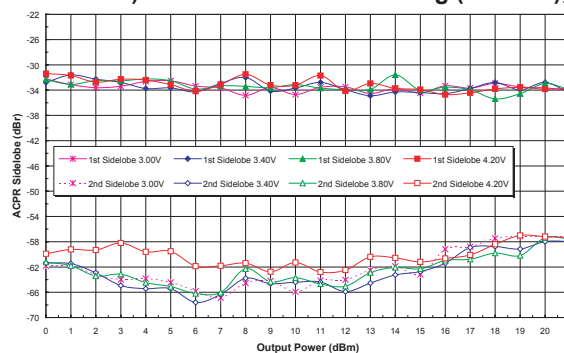
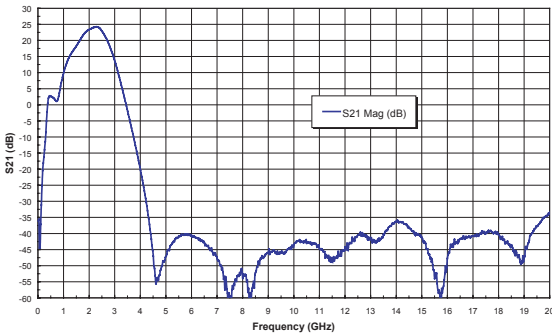


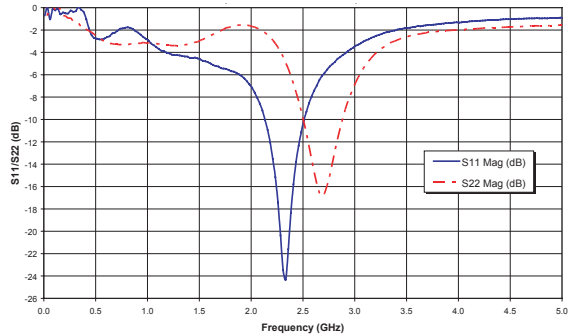
Figure 13: Tx Path ACPR Sidelobes 1&2 vs. Output Power Across Power Supply Voltage (Freq = 2.45 GHz, $T_A = +25^\circ\text{C}$) 802.11b Gaussian Filtering ($bT = 0.5$), 1 Mbps



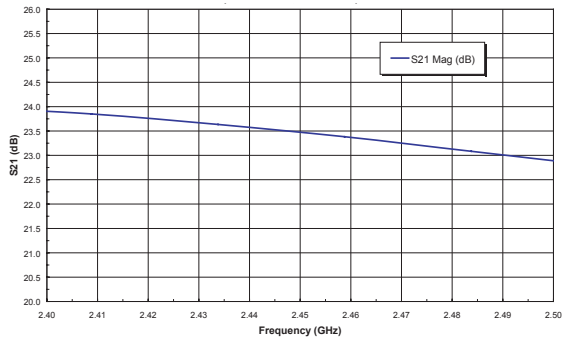
**Figure 14: 2.4 GHz Tx Path S-Parameters
S21 Response
(V_{CC} = +3.8 V, T_C = +25°C)**



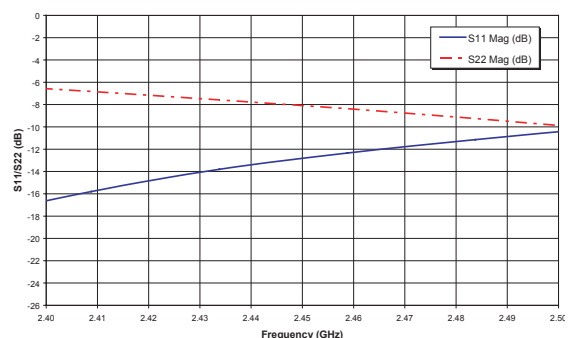
**Figure 15: 2.4 GHz Tx Path S-Parameters
S11 & S22 Response
(V_{CC} = +3.8 V, T_A = +25°C)**



**Figure 16: 2.4 GHz Tx Path S-Parameters
S21 Response (Narrow band)
(V_{CC} = +3.8 V, T_A = +25°C)**



**Figure 17: 2.4 GHz Tx Path S-Parameters
S11 & S22 Response (Narrow band)
(V_{CC} = +3.8 V, T_A = +25°C)**



PERFORMANCE DATA - RECEIVE PATH

Figure 18: Receive Path Noise Figure Across Supply Voltage (V_{LNA_EN} = +3.1 V, T_A = +25°C)

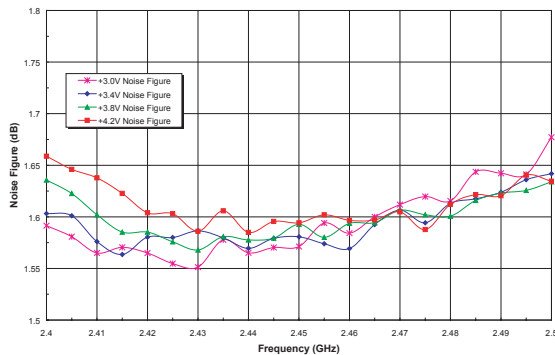
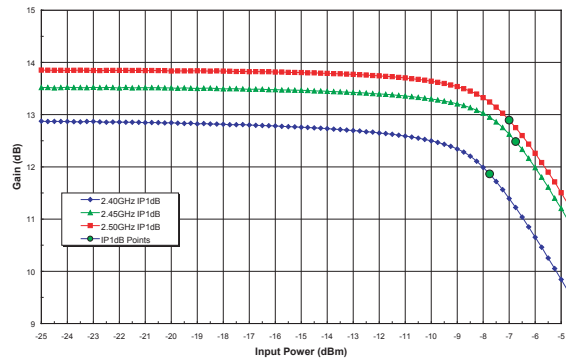
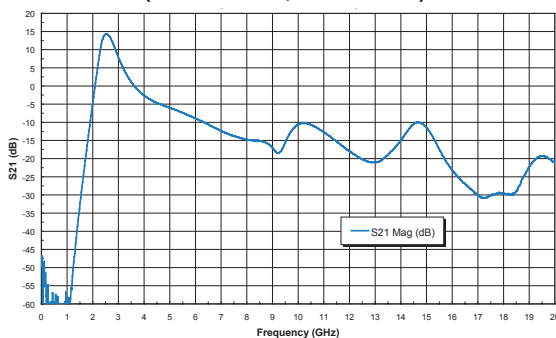


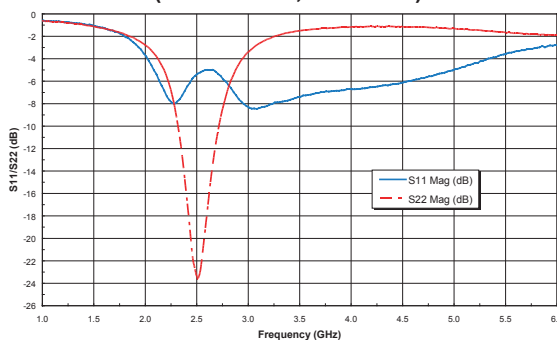
Figure 19: Receive Path Input P1dB Across Freq (V_{CC} = +3.8, V_{LNA_EN} = +3.1 V, T = +25°C)



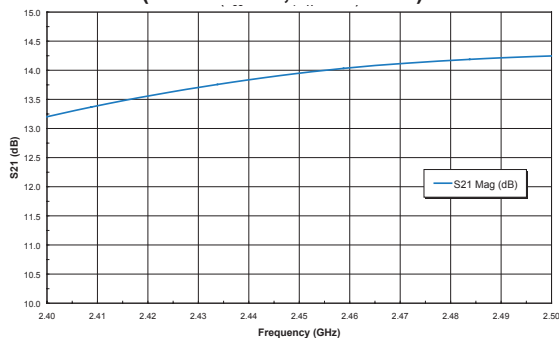
**Figure 20: Rx Path S-Parameters
S21 Response
(V_{CC} = +3.8 V, T_A = +25°C)**



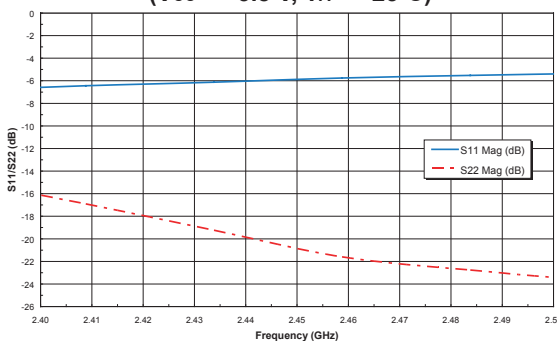
**Figure 21: Rx Path S-Parameters
S11 & S22 Response
(V_{CC} = +3.8 V, T_c = 25°C)**



**Figure 22: Rx Path S-Parameters
S21 Response (Narrow band)
(V_{CC} = +3.8 V, T_A = +25°C)**

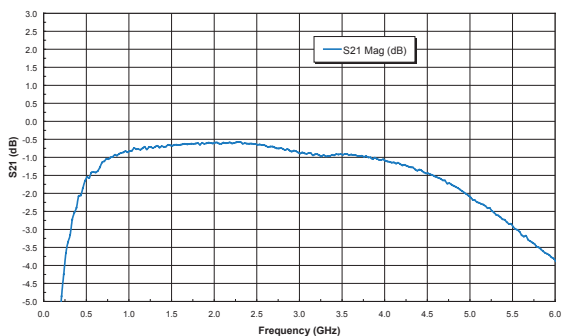


**Figure 23: Rx Path S-Parameters
S11 & S22 Response (Narrow band)
(V_{CC} = +3.8 V, T_A = +25°C)**

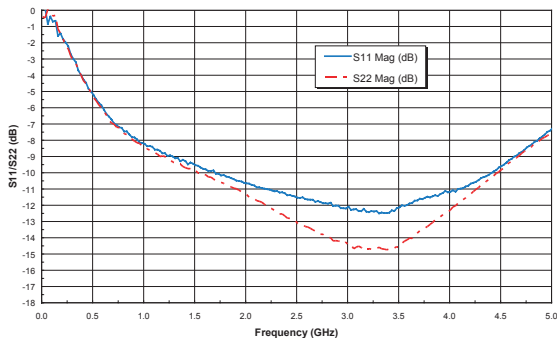


PERFORMANCE DATA - BLUETOOTH PATH

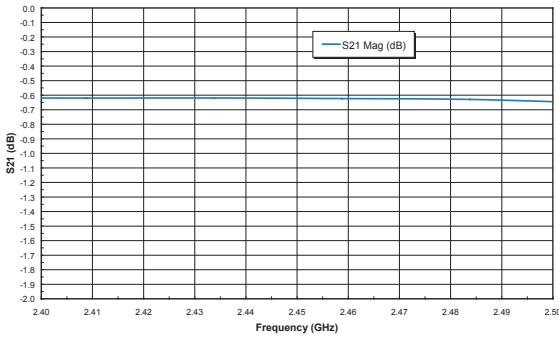
**Figure 24: Bluetooth S-Parameters
S21 Response
(V_{CC} = +3.8 V, T_A = +25°C)**



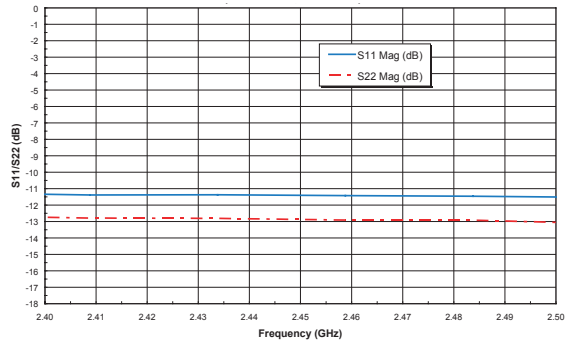
**Figure 25: Bluetooth S-Parameters
S11 & S22 Response
(V_{CC} = +3.8 V, T_A = +25°C)**



**Figure 26: Bluetooth S-Parameters
S21 Response (Narrow band)
(V_{CC} = +3.8 V, T_A = +25°C)**



**Figure 27: Bluetooth S-Parameters
S11 & S22 Response (Narrow band)
(V_{CC} = +3.8 V, T_A = +25°C)**



APPLICATION INFORMATION

Following is an application schematic for the AWL9232. A 10uF decoupling capacitor should be connected to the system voltage supply line for low frequency bypassing.

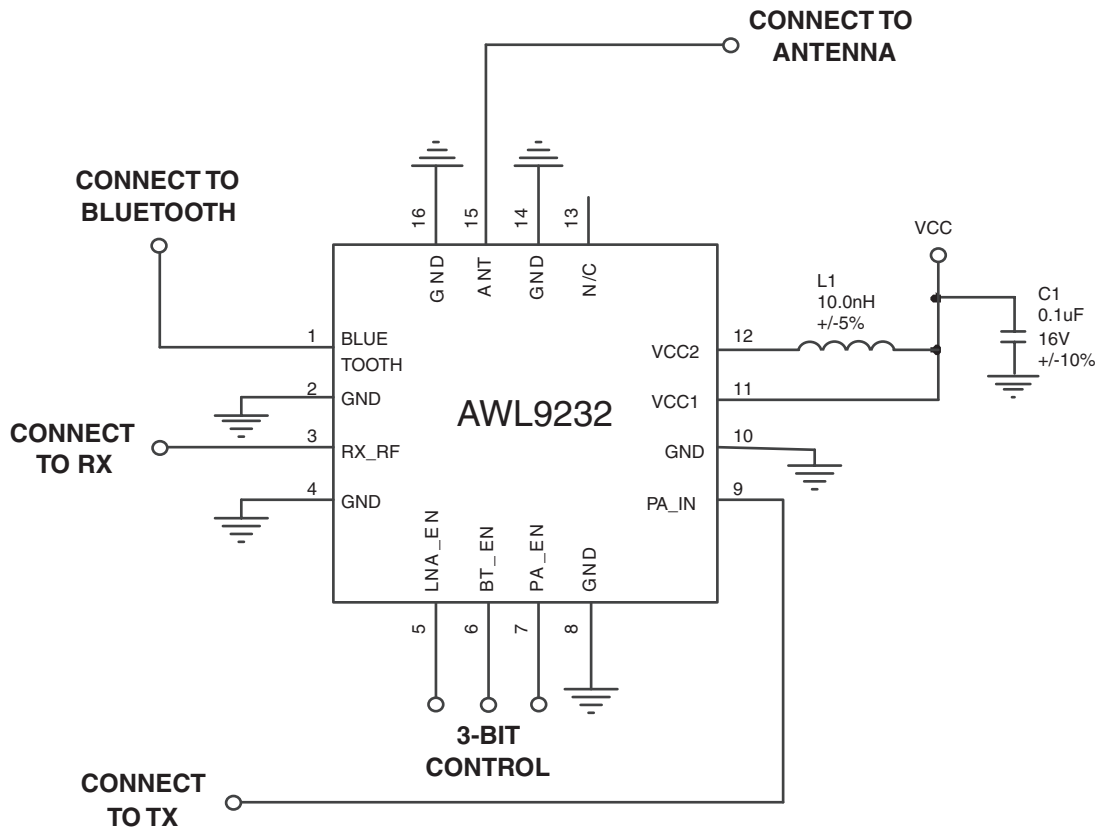
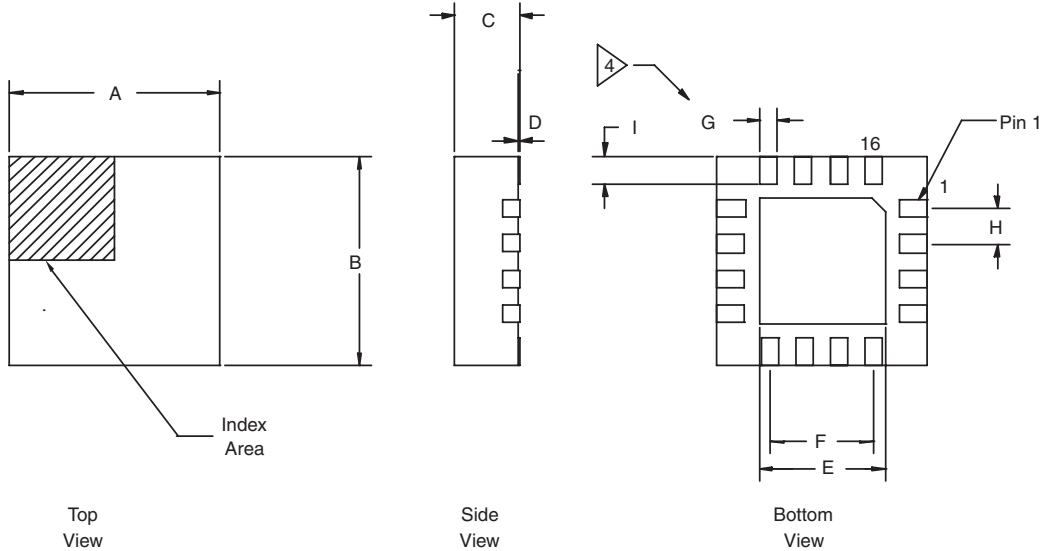


Figure 26: Application Circuit

PACKAGE OUTLINE

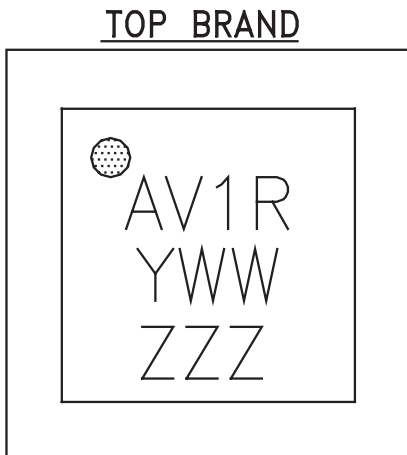
The AWL9232 is offered in a 3 mm x 3 mm x 0.55 mm surface mount ULPC package:



DIMENSION	MILLIMETERS		
	MIN	TYP	MAX
A	2.90	3.00	3.10
B	2.90	3.00	3.10
C	0.50	0.55	0.60
D	0.00	0.02	0.05
E	1.55	1.70	1.85
F	1.50 BSC.		
G	0.18	0.25	0.30
H	0.50 BSC.		
I	0.20	0.30	0.40

1. All dimensions are in millimeters, angles in degrees.
2. The terminal #1 identifier and pad numbering convention shall conform to JESD 95-1 SPP-012
3. Lead coplanarity: 0.05 max.
4. Dimension applies to metalized pad and is measured between 0.25 and 0.30 MM from pad tip.

Figure 27: S35 Package Outline - 16 Pin 3 mm x 3 mm x 0.55 mm Surface Mount Module



NOTES:

1. ANADIGICS LOGO SIZE: N/A
2. PART NUMBER: AV = 2 DIGIT PART NUMBER
1 = CURRENT ISSUE NUMBER OF BOM.
R = ROHS COMPLIANCE.
3. YEAR AND WORK WEEK: YWW = LAST DIGIT OF YEAR, TWO DIGIT WORK WEEK.
4. LOT NUMBER: ZZZ = LAST THREE NUMBERS OF WAFER LOT NUMBER
5. PIN 1 INDICATOR: MOLD NOTCH -or- INK DOT
6. COUNTRY CODE: N/A
7. TYPE : ELITE
SIZE : 1.5-POINT
COLOR : LASER

Figure 28: Branding Specification

RECOMMENDED PCB LAYOUT

The following diagram shows the suggested application PCB layout:

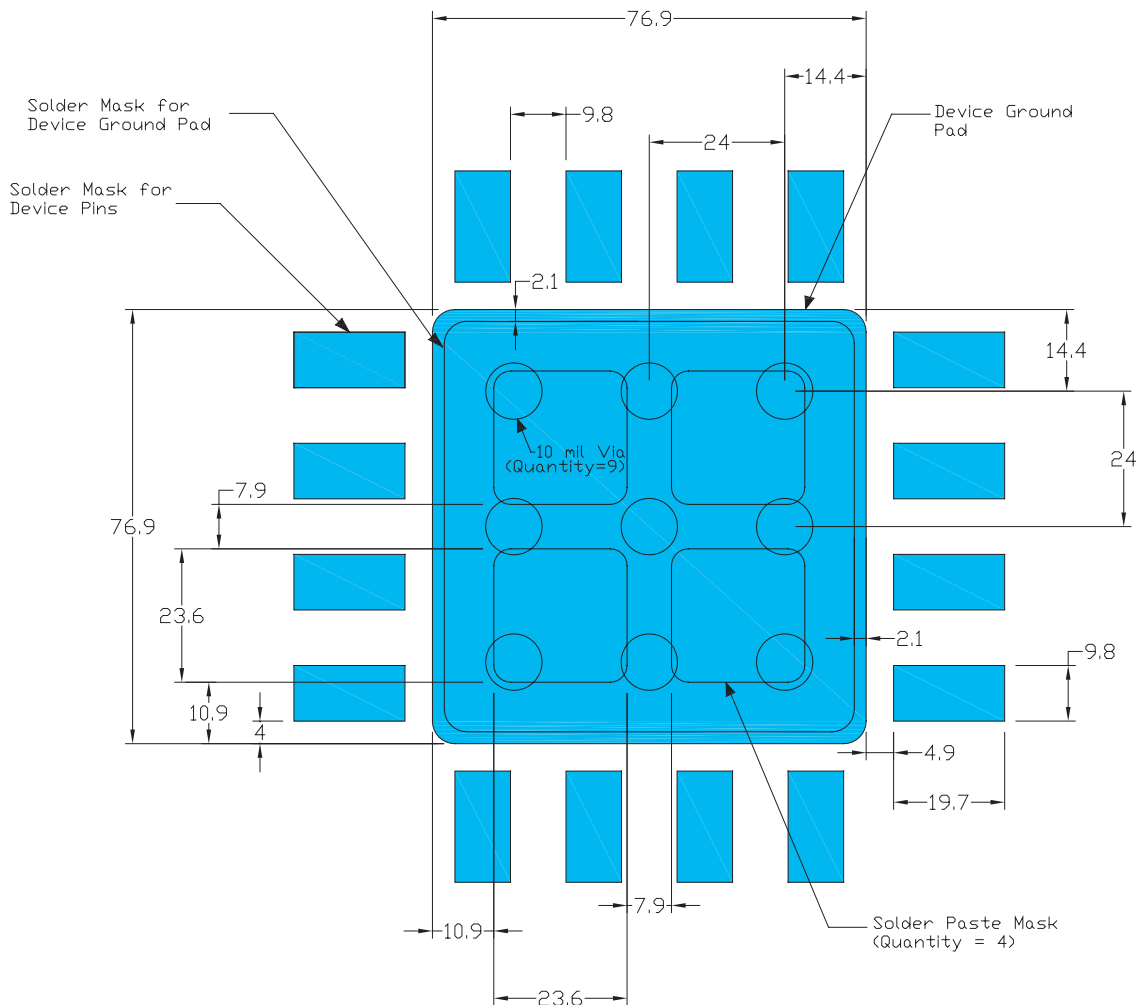


Figure 29: Recommended PCB Layout (all units in mils)

ORDERING INFORMATION

ORDER NUMBER	TEMPERATURE RANGE	PACKAGE DESCRIPTION	COMPONENT PACKAGING
AWL9232RS35P8	-40 °C to +85°C	16 Pin 3 mm x 3 mm x 0.55 mm Surface Mount ULPCC	2,500 piece Tape and Reel 13 inch Reel
AWL9232RS35Q7	-40 °C to +85°C	16 Pin 3 mm x 3 mm x 0.55 mm Surface Mount ULPCC	2,500 piece Tape and Reel 7 inch Reel
AWL9232RS35Q1	-40 °C to +85°C	16 Pin 3 mm x 3 mm x 0.55 mm Surface Mount ULPCC	1000 piece Tape and Reel
EVA9232RS35	-40 °C to +85°C	16 Pin 3 mm x 3 mm x 0.55 mm Surface Mount ULPCC	1 piece Evaluation Board

**ANADIGICS, Inc.**

141 Mount Bethel Road
Warren, New Jersey 07059, U.S.A.

Tel: +1 (908) 668-5000

Fax: +1 (908) 668-5132

URL: <http://www.anadigics.com>

E-mail: Mktg@anadigics.com

IMPORTANT NOTICE

ANADIGICS, Inc. reserves the right to make changes to its products or to discontinue any product at any time without notice. The product specifications contained in Advanced Product Information sheets and Preliminary Data Sheets are subject to change prior to a product's formal introduction. Information in Data Sheets have been carefully checked and are assumed to be reliable; however, ANADIGICS assumes no responsibilities for inaccuracies. ANADIGICS strongly urges customers to verify that the information they are using is current before placing orders.

WARNING

ANADIGICS products are not intended for use in life support appliances, devices or systems. Use of an ANADIGICS product in any such application without written consent is prohibited.