



晶采光電科技股份有限公司  
AMPIRE CO., LTD.

## SPECIFICATIONS FOR LCD MODULE

<b>CUSTOMER</b>	
<b>CUSTOMER PART NO.</b>	
<b>AMPIRE PART NO.</b>	<b>AT-09632JFIEB-52H(R)</b>
<b>APPROVED BY</b>	
<b>DATE</b>	

Approved For Specifications

Approved For Specifications & Sample

**AMPIRE CO., LTD.**

**TOWER A, 4F, No.114, Sec. 1, HSIN-TAI 5th RD., HIS-CHIH,  
TAIPEI HSIEN, TAIWAN(R.O.C.)**

台北縣汐止鎮新台五路一段114號4樓(東方科學園區A棟)

**TEL:886-2-26967269, FAX:886-2-26967196 or 886-2-26967270**

APPROVED BY	CHECKED BY	ORGANIZED BY

## RECORD OF REVISION

<b>Revision Date</b>	<b>Page</b>	<b>Contents</b>	<b>Editor</b>
2005/7/1	-	New Release	Tony
2006/9/7	3	Modify Mechanical data	Tony

## 1 FEATURES

- (1) Display format : 96 × 32 dot-matrix, 1/33 duty, 1/6 Bias.
- (2) Construction : LCD panel, Blue EL backlight and TAB IC
- (3) Display type : FSTN, Transflective, Positive, 6 o'clock view
- (4) LCD Controller :NT7534
- (5) Interface for 8-bits 80 series MPU.
- (6) Extended temperature type.
- (7) IC Segment 0~95.
- (8) ROHS compliable.

## 2 MECHANICAL DATA

Parameter	Stand Value	Unit
Dot size	0.235(W) × 0.235(H)	mm
Dot pitch	0.25(W) × 0.25(H)	mm
Viewing area	30.0(W) × 9.5(H)	mm
Module size	39.5(W) × 33.9(H) × 2.2 max (T)	mm

## 3 ABSOLUTE MAXIMUM RATINGS

Parameter	Symbol	Min	Max	Unit	
Logic Circuit Supply Voltage	VDD	2.7	3.5	V	
LCD Driving Voltage	VLCD	--	6.0	V	
Input Voltage	VI	VSS	VDD	V	
Extended temp. type	Operating Temp.	TOP	0	50	°C
	Storage Temp.	TSTG	-20	70	°C

#### 4 ELECTRO-OPTICAL CHARACTERISTICS

Parameter	Symbol	Condition	Min	Typ	Max	Unit	Note
<b>----- Electronic Characteristics -----</b>							
Logic Circuit Supply Voltage	VDD-VSS	--	2.7	--	3.5	V	
LCD Driving Voltage	V0-VSS	-20 °C	--	--	--	V	
		25 °C	--	6.0	--		
		70 °C	--	--	--		
Input Voltage	VIH	--	2.2	--	VDD	V	
	VIL	--	VSS	--	0.6	V	
Logic Supply Current	IDD	VDD = 3.0V	--	--	0.3	mA	
<b>----- Optical Characteristics -----</b>							
Contrast	CR	FSTN type	--	7	--		Note 1
Rise Time	tr	25°C	--	200	--	ms	Note 2
Fall Time	tf	25°C	--	200	--	ms	
Viewing Angle Range	θ f	25°C & CR≥2	--	40	--	Deg.	Note 3
	θ b		--	35	--		
	θ l		--	40	--		
	θ r		--	40	--		
Frame Frequency	fF	25°C	--	33	--	Hz	

(NOTE 1) Contrast ratio :

CR = (Brightness in OFF state) / (Brightness in ON state)

( NOTE 2 ) Response time :

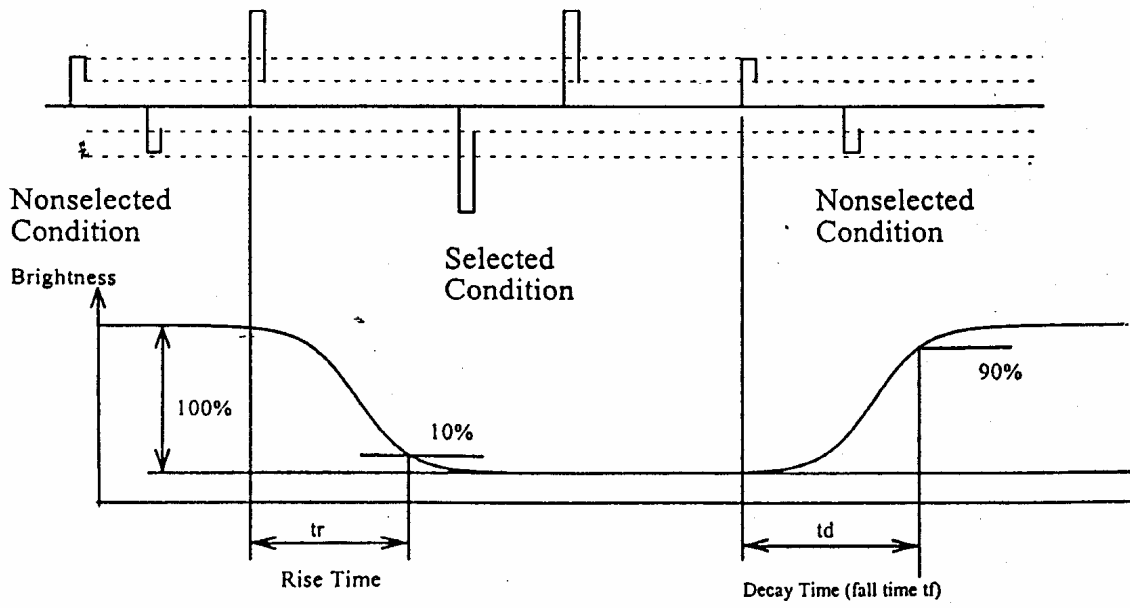

(NOTE 3) Viewing angle

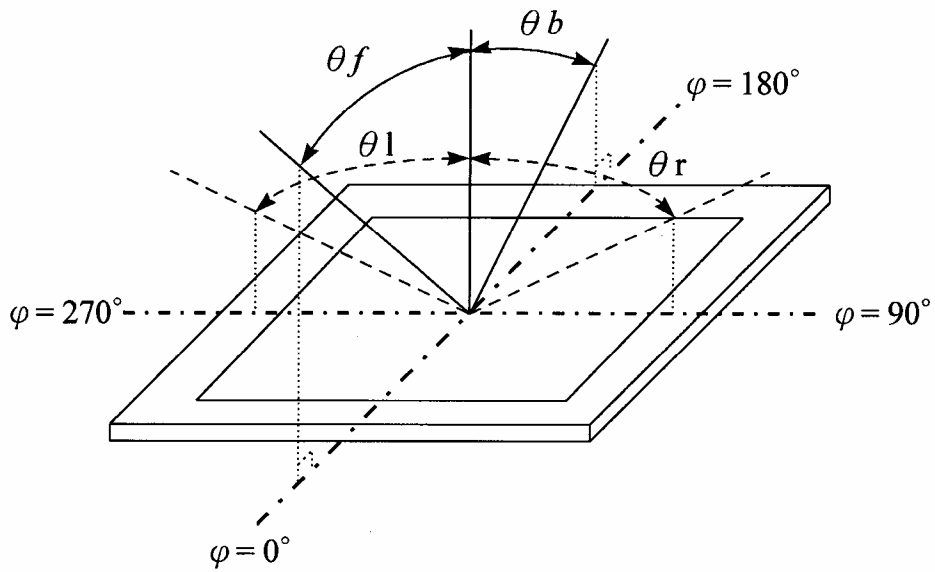

## EL Back-light Electrical Specification

<b>Parameter</b>	<b>Specification</b>	<b>Unit</b>
Color	Blue	-
Voltage	Vrms = 110	V(AC)
Frequency	Sine Wave = 400	Hz
Current Density	0.12	mA / cm <sup>2</sup>
Bare EL Initial Brightness	40	cd / m <sup>2</sup>
LCM Initial Brightness	6	cd / m <sup>2</sup>

# 5 BLOCK DIAGRAM

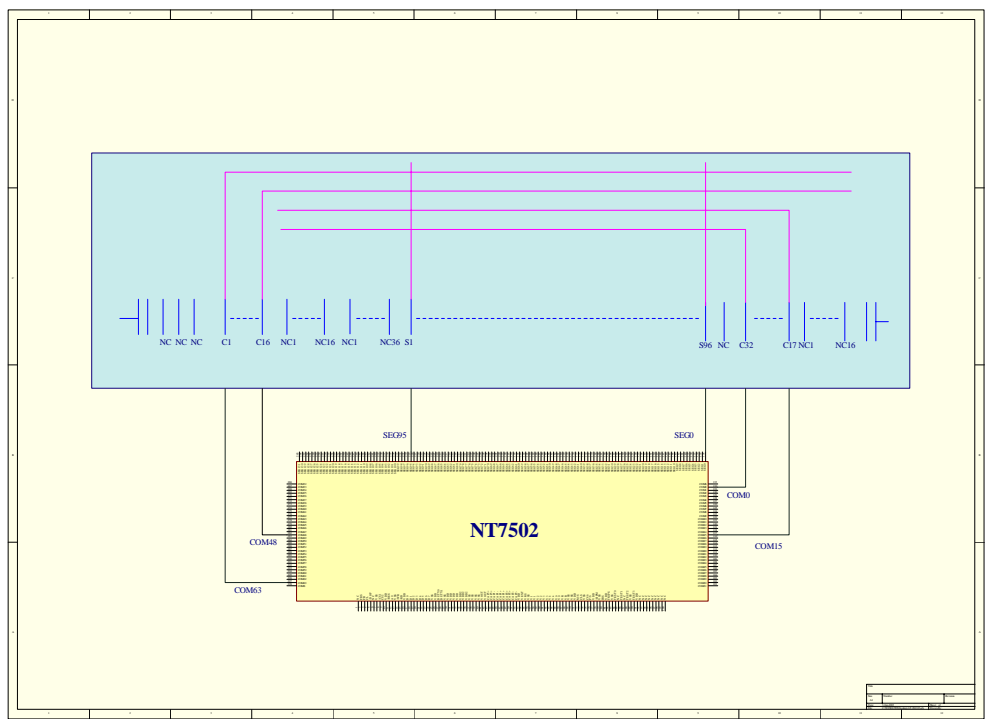
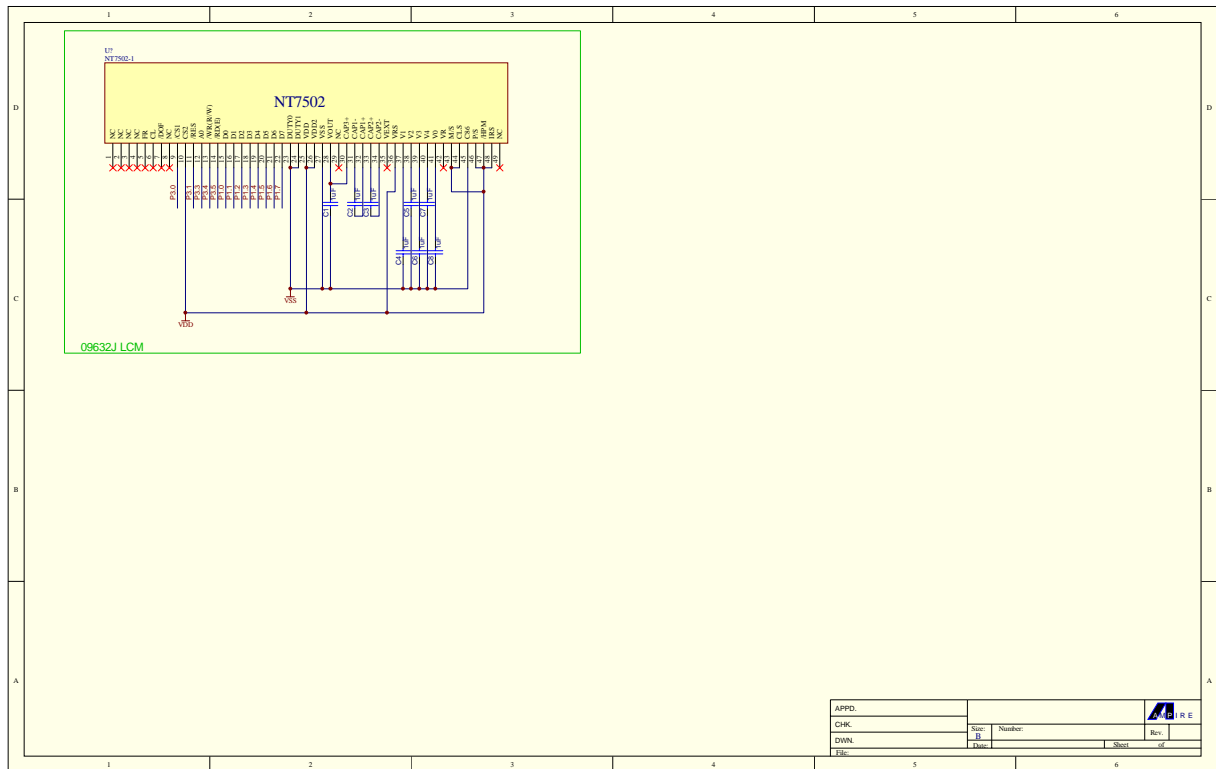

## 6 INTERFACE

No.	Symbol	Function
1~4	NC	No connection
5	FR	M/S="H" Output; M/S="L" Input.
6	CL	This is the display clock input terminal.
7	DOF	M/S="H" Output; M/S="L" Input.
8	NC	No connection
9	CS1	Chip select
10	CS2	Chip select
11	RES	Set="L" Settings are initialized.
12	A0	"H" D0-D7 are display data; "L" D0-D7 are control data.
13	WR	8080 MPU It's active"L"; 6800 MPU "H"Read, "L"Write.
14	RD	8080 MPU It's active"L"; 6800 MPU It's active"H".
15~22	D0~D7	8-bit data bus for 80 series MPU
23	DUTY0	Select the LCD driver duty.
24	DUTY1	Select the LCD driver duty.
25	VDD	Power supply 2.4-3.5V
26	VDD2	This is the reference power supply.
27	VSS	Ground
28	VOUT	DC/DC Voltage Converter.
29	NC	No connection
30	CAP3+	Capacitor3+ pad for internal DC/DC Voltage Converter.
31	CAP1-	Capacitor1- pad for internal DC/DC Voltage Converter.
32	CAP1+	Capacitor1+ pad for internal DC/DC Voltage Converter.
33	CAP2+	Capacitor2+ pad for internal DC/DC Voltage Converter.
34	CAP2-	Capacitor2- pad for internal DC/DC Voltage Converter.
35	VEXT	Vext must be > 2.4V and < Vdd2.
36	VRS	"0" using the external Vref; "1" using the internal Vref.
37	V1	LCD driver supply voltage:
38	V2	Voltage should have the following relationship; $V0 \geq V1 \geq V2 \geq V3 \geq V4 \geq Vss$
39	V3	
40	V4	
41	V0	
42	VR	Voltage adjustment pad.
43	M/S	Select the Master/Slave operation.
44	CLS	"H" internal oscillator circuit is enabled. "L" internal oscillator circuit is disabled.



45	C86	"H" 6800 Series MPU interface; "L" 8080 MPU interface.
46	P/S	This is parallel data.
47	HPM	"H" Normal mode; "L" Hight power mode.
48	IRS	"H" use the internal resistors "L" Don't use the internal resistors
49	NC	No connection

## 7 INSTRUCTION SET

Command	Code											Function
	A0	$\overline{RD}$	$\overline{WR}$	D7	D6	D5	D4	D3	D2	D1	D0	
(1) Display ON/OFF	0	1	0	1	0	1	0	1	1	1	D	Turns on LCD panel when goes high, and turns off when goes low
(2) Set Display Start Line	0	1	0	0	1	Display start address					Specifies RAM display line for COM0	
(3) Set Page Address	0	1	0	1	0	1	1	Page address				Sets the display RAM page in Page Address register
(4) Set Column Address 4 higher bits	0	1	0	0	0	0	1	Higher column address				Sets 4 higher bits of column address of display RAM in register
(4) Set column Address 4 lower bits	0	1	0	0	0	0	0	Lower column address				Sets 4 lower bits of column address of display RAM in register
(5) Read Status	0	0	1	Status				0	0	0	0	Reads the status information
(6) Write Display Data	1	1	0	Write data								Writes data in display RAM
(7) Read Display Data	1	0	1	Read data								Reads data from display RAM
(8) ADC select	0	1	0	1	0	1	0	0	0	0	D	Sets the display RAM address SEG output correspondence
(9) Normal/Reverse Display	0	1	0	1	0	1	0	0	1	1	D	Normal indication when low, but full indication when high
(10) Entire Display ON/OFF	0	1	0	1	0	1	0	0	1	0	0 1	Selects normal display (0) or Entire Display ON (1)
(11) Set LCD Bias	0	1	0	1	0	1	0	0	0	1	D	Sets LCD drive voltage bias ratio
(12) Read-Modify-Write	0	1	0	1	1	1	0	0	0	0	0	Increments Column Address counter during each write
(13) End	0	1	0	1	1	1	0	1	1	1	0	Releases the Read-Modify-Write
(14) Reset	0	1	0	1	1	1	0	0	0	1	0	Resets internal functions
(15) Common output mode select	0	1	0	1	1	0	0	D	*	*	*	Selects COM output scan direction. * Invalid data
(16) Set Power Control	0	1	0	0	0	1	0	1	Operation status			Selects the power circuit operation mode
(17) V0 voltage regulator internal resistor ratio set	0	1	0	0	0	1	0	0	Resistor ratio			Select internal resistor ratio (Rb / Ra) mode
(18) Electronic volume mode set	0	1	0	1	0	0	0	0	0	0	1	Set the V0 output voltage electronic volume register
Electronic Volume Register set	0	1	0	*	*	Electronic control value						
(19) Set static indicator On/Off	0	1	0	1	0	1	0	1	1	0	D	Set static indicator On/Off 0: OFF 1: ON
Set Static indicator register	0	1	0	*	*	*	*	*	*	Mode		Set the flashing mode
(20) Power Save	-	-	-	-	-	-	-	-	-	-	-	Compound command of display OFF and entire display ON
(21) NOP	0	1	0	1	1	1	0	0	0	1	1	Command for non-operation
(22) Test Command	0	1	0	1	1	1	1	*	*	*	*	IC Test command. Do not use!
(23) Test Mode Reset	0	1	0	1	1	1	1	0	0	0	0	Command of test mode reset

Note: Do not use any other command, or the system malfunction may result.

## 8 TIMING CHARACTERISTICS

(1) System buses Read/Write characteristics 1 (For the 8080 Series MPU)

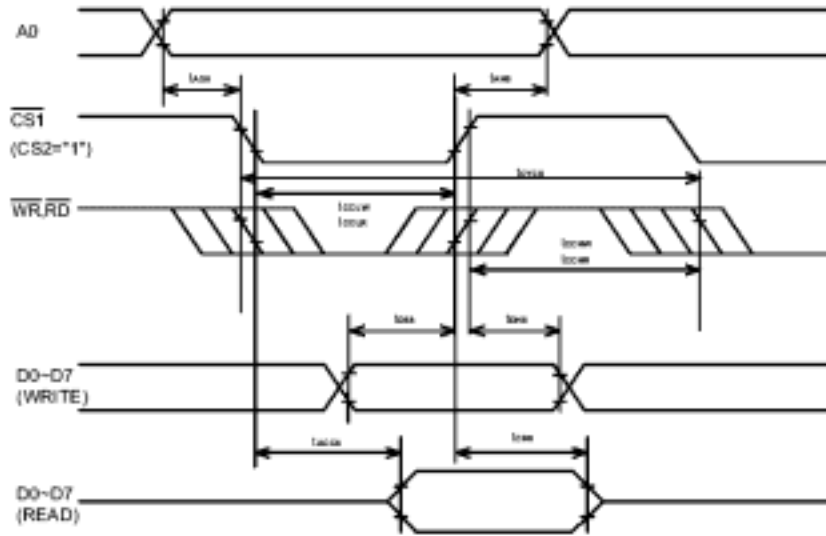

( $V_{DD}=2.7 - 3.3V$ ,  $T_A = -40 - 85^\circ C$ )

Symbol	Parameter	Min.	Typ.	Max.	Unit	Condition
$T_{AH}$	Address hold time	0			ns	
$T_{AS}$	Address setup time	0			ns	
$T_{CY}$	System cycle time	300			ns	
$T_{CCLW}$	Control L pulse width (WR)	60			ns	
$T_{CCLR}$	Control L pulse width (RD)	120			ns	
$T_{CCHW}$	Control H pulse width (WR)	60			ns	
$T_{CCHR}$	Control H pulse width (RD)	60			ns	
$T_{DS}$	Data setup time	40			ns	
$T_{DH}$	Data hold time	15			ns	
$T_{ACC}$	$\overline{RD}$ access time			140	ns	$C_L=100pF$
$T_{CH}$	Output disable time	10		100	ns	$C_L=100pF$

\*1 The input signal rise time and fall time ( $t_r$ ,  $t_f$ ) is specified at 15ns or less. When the system cycle time is extremely fast,  $(t_r+t_f) \leq (t_{CY}-t_{CCLW}-t_{CCHW})$  for  $(t_r+t_f) \leq (t_{CY}-t_{CCLR}-t_{CCHR})$  are specified.

\*2 All timing is specified using 20% and 80% of  $V_{DD}$  as the reference.

\*3  $t_{CCLW}$  and  $t_{CCLR}$  are specified as the overlap between  $\overline{CS1}$  being "L" ( $CS2="H"$ ) and  $\overline{WR}$  and  $\overline{RD}$  being at the "L" level.

### System buses Read/Write Characteristics 2 (6800 Series MPU)

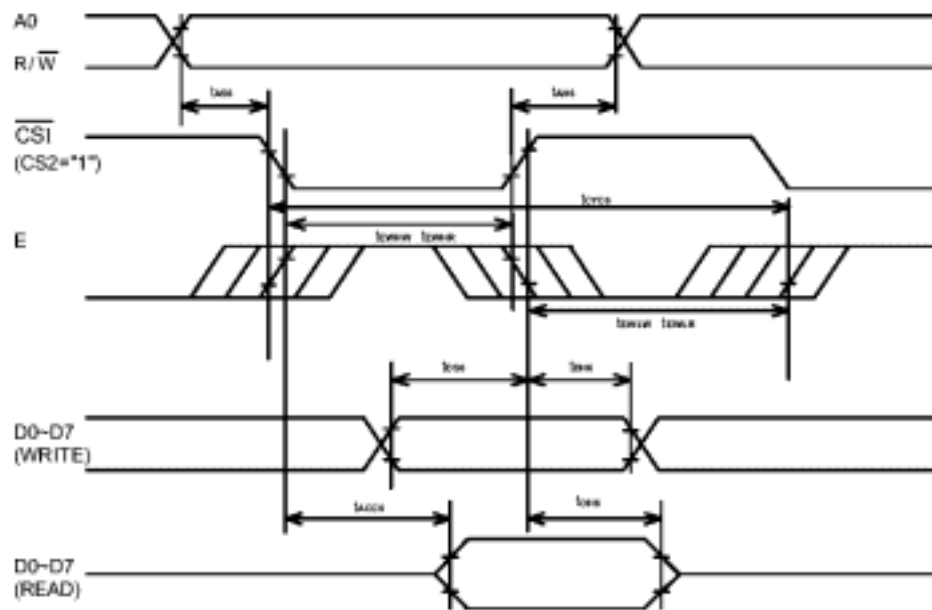

( $V_{DD}=2.7 - 3.3V$ ,  $T_A = -40 - 85^\circ C$ )

Symbol	Parameter	Min.	Typ.	Max.	Unit	Condition
T <sub>CYC6</sub>	System cycle time	300			nS	
T <sub>AS6</sub>	Address setup time	0			nS	
T <sub>AH6</sub>	Address hold time	0			nS	
T <sub>DS6</sub>	Data setup time	40			nS	
T <sub>DH6</sub>	Data hold time	15			nS	
T <sub>OH6</sub>	Output disable time	10		100	nS	$C_L=100pF$
T <sub>ACC6</sub>	Access time			140	nS	$C_L=100pF$
T <sub>EWHR</sub>	Enable H pulse width (Read)	120			nS	
T <sub>EWHW</sub>	Enable H pulse width (Write)	60			nS	
T <sub>EWLR</sub>	Enable L pulse width (Read)	60			nS	
T <sub>EWLW</sub>	Enable L pulse width (Write)	60			nS	

\*1 The input signal rise time and fall time ( $t_r$ ,  $t_f$ ) is specified at 15ns or less. When the system cycle time is extremely fast,  $(t_r+t_f) \leq (t_{CYC6}-t_{EWLW}-t_{EWHW})$  for  $(t_r+t_f) \leq (t_{CYC6}-t_{EWLR}-t_{EWHR})$  are specified.

\*2 All timing is specified using 20% and 80% of  $V_{DD}$  as the reference.

\*3  $t_{EWLW}$  and  $t_{EWLR}$  are specified as the overlap between  $\overline{CS1}$  being "L" ( $CS2="H"$ ) and E.

## **9 QUALITY AND RELIABILITY**

### **9.1 TEST CONDITIONS**

Tests should be conducted under the following conditions :

Ambient temperature :  $25 \pm 5^{\circ}\text{C}$

Humidity :  $60 \pm 25\% \text{ RH}$ .

### **9.2 SAMPLING PLAN**

Sampling method shall be in accordance with MIL-STD-105E , level II, normal single sampling plan .

### **9.3 ACCEPTABLE QUALITY LEVEL**

A major defect is defined as one that could cause failure to or materially reduce the usability of the unit for its intended purpose. A minor defect is one that does not materially reduce the usability of the unit for its intended purpose or is an infringement from established standards and has no significant bearing on its effective use or operation.

### **9.4 APPEARANCE**

An appearance test should be conducted by human sight at approximately 30 cm distance from the LCD module under fluorescent light. The inspection area of LCD panel shall be within the range of following limits.

## 9.5 INSPECTION QUALITY CRITERIA

Item	Description of defects			Class of Defects	Acceptable level (%)	
Function	Short circuit or Pattern cut			Major	0.65	
Dimension	Deviation from drawings			Major	1.5	
Black spots	Ave . dia . D	area A	area B	Minor	2.5	
	D≤0.2	Disregard				
	0.2<D≤0.3	3	4			
	0.3<D≤0.4	2	3			
	0.4<D	0	1			
Black lines	Width W, Length L		A	B	Minor	2.5
	W≤0.03		disregard			
	0.03<W≤0.05		3	4		
	0.05<W≤0.07 , L≤3.0		1	1		
	See line criteria					
Bubbles in polarizer	Average diameter D 0.2 < D < 0.5 mm for N = 4 , D > 0.5 for N = 1			Minor	2.5	
Color uniformity	Rainbow color or newton ring.			Minor	2.5	
Glass Scratches	Obvious visible damage.			Minor	2.5	
Contrast ratio	See note 1			Minor	2.5	
Response time	See note 2			Minor	2.5	
Viewing angle	See note 3			Minor	2.5	

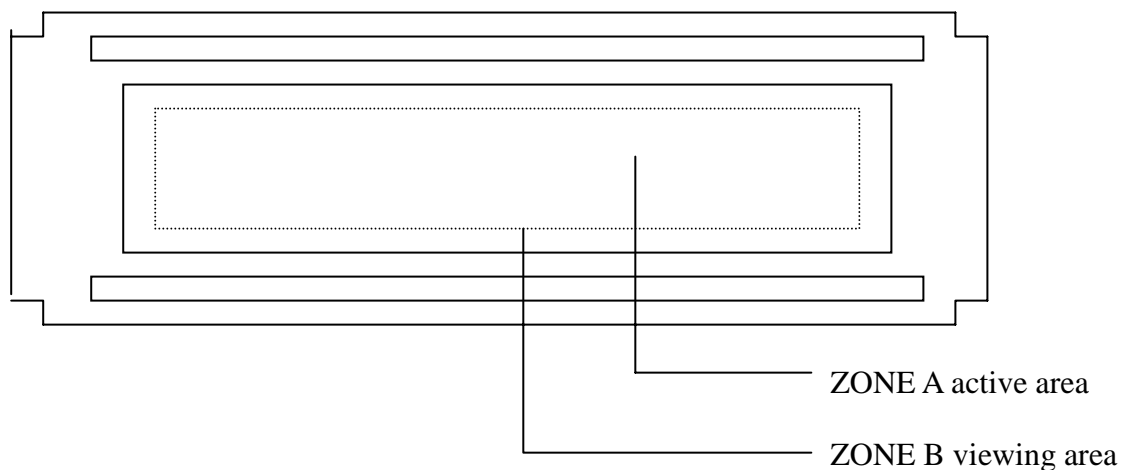

## 9.6 RELIABILITY

Test Item	Test Conditions	Note
High Temperature Operation	70±3°C , t=96 hrs	
Low Temperature Operation	-20±3°C , t=96 hrs	
High Temperature Storage	80±3°C , t=96 hrs	1,2
Low Temperature Storage	-30±3°C , t=96 hrs	1,2
Thermal Shock Test	-30°C ~ 25°C ~ 80°C 30 min. 5 min. 30 min. ( 1 cycle ) Total 5 cycle	1,2
Vibration Test (Packing)	Sweep frequency : 10~55~10 Hz/1min Amplitude : 0.75mm Test direction : X.Y.Z/3 axis Duration : 30min/each axis	2

Note 1 : Condensation of water is not permitted on the module.

Note 2 : The module should be inspected after 1 hour storage in normal conditions  
(15-35°C , 45-65%RH).

Definitions of life end point :

- Current drain should be smaller than the specific value.
- Function of the module should be maintained.
- Appearance and display quality should not have degraded noticeably.
- Contrast ratio should be greater than 50% of the initial value.

## **10 HANDLING PRECAUTIONS**

- (1) An LCD module is a fragile item and should not be subjected to strong mechanical shocks.
- (2) Avoid applying pressure to the module surface. This will distort the glass and cause a change in color.
- (3) Under no circumstances should the position of the bezel tabs or their shape be modified.
- (4) Do not modify the display PCB in either shape or positioning of components.
- (5) Do not modify or move location of the zebra or heat seal connectors.
- (6) The device should only be soldered to during interfacing. Modification to other areas of the board should not be carried out.
- (7) In the event of LCD breakage and resultant leakage of fluid do not inhale, ingest or make contact with the skin. If contact is made rinse immediately.
- (8) When cleaning the module use a soft damp cloth with a mild solvent, such as Isopropyl or Ethyl alcohol. The use of water, ketone or aromatic is not permitted.
- (9) Prior to initial power up input signals should not be applied.
- (10) Protect the module against static electricity and observe appropriate anti-static precautions.



