

## Silicon PNP Power Transistors

2SA1804

## DESCRIPTION

- With TO-3PML package
- Complement to type 2SC4689

## APPLICATIONS

- Power amplifier applications
- Recommend for 55W high fidelity audio frequency amplifier output stage

## PINNING

PIN	DESCRIPTION
1	Base
2	Collector
3	Emitter

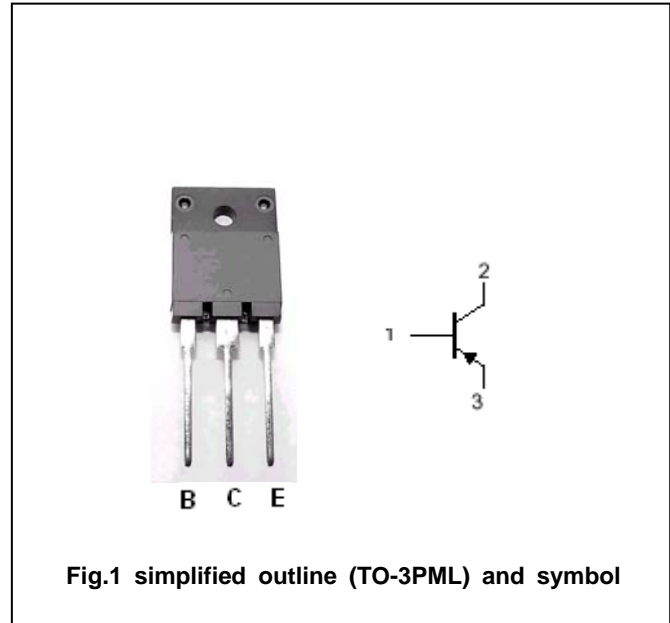
Absolute maximum ratings( $T_a=25^\circ\text{C}$ )

SYMBOL	PARAMETER	CONDITIONS	VALUE	UNIT
$V_{CBO}$	Collector-base voltage	Open emitter	-120	V
$V_{CEO}$	Collector-emitter voltage	Open base	-120	V
$V_{EBO}$	Emitter-base voltage	Open collector	-5	V
$I_C$	Collector current		-8	A
$I_{CM}$	Collector current-peak		-16	A
$I_B$	Base current		-0.8	A
$P_C$	Collector power dissipation	$T_C=25^\circ\text{C}$	70	W
$T_j$	Junction temperature		150	$^\circ\text{C}$
$T_{stg}$	Storage temperature		-55~150	$^\circ\text{C}$

## Silicon PNP Power Transistors

## 2SA1804

## CHARACTERISTICS

T<sub>j</sub>=25°C unless otherwise specified

SYMBOL	PARAMETER	CONDITIONS	MIN	TYP.	MAX	UNIT
V <sub>(BR)CEO</sub>	Collector-emitter breakdown voltage	I <sub>C</sub> =-50mA; I <sub>B</sub> =0	-120			V
V <sub>CE(sat)</sub>	Collector-emitter saturation voltage	I <sub>C</sub> =-6A; I <sub>B</sub> =-0.6 A			-2.0	V
V <sub>BE</sub>	Base-emitter voltage	I <sub>C</sub> =-4A ; V <sub>CE</sub> =-5V			-1.5	V
I <sub>CBO</sub>	Collector cut-off current	V <sub>CB</sub> =-120V; I <sub>E</sub> =0			-5	μ A
I <sub>EBO</sub>	Emitter cut-off current	V <sub>EB</sub> =-5V; I <sub>C</sub> =0			-5	μ A
h <sub>FE-1</sub>	DC current gain	I <sub>C</sub> =-1A ; V <sub>CE</sub> =-5V	55		160	
h <sub>FE-2</sub>	DC current gain	I <sub>C</sub> =-4A ; V <sub>CE</sub> =-5V	35			
f <sub>T</sub>	Transition frequency	I <sub>C</sub> =-1A ; V <sub>CE</sub> =-5V		30		MHz
C <sub>OB</sub>	Output capacitance	I <sub>E</sub> =0; V <sub>CB</sub> =10V; f=1MHz		420		pF

◆ h<sub>FE</sub> classifications

R	O
55-110	80-160

Silicon PNP Power Transistors

2SA1804

PACKAGE OUTLINE

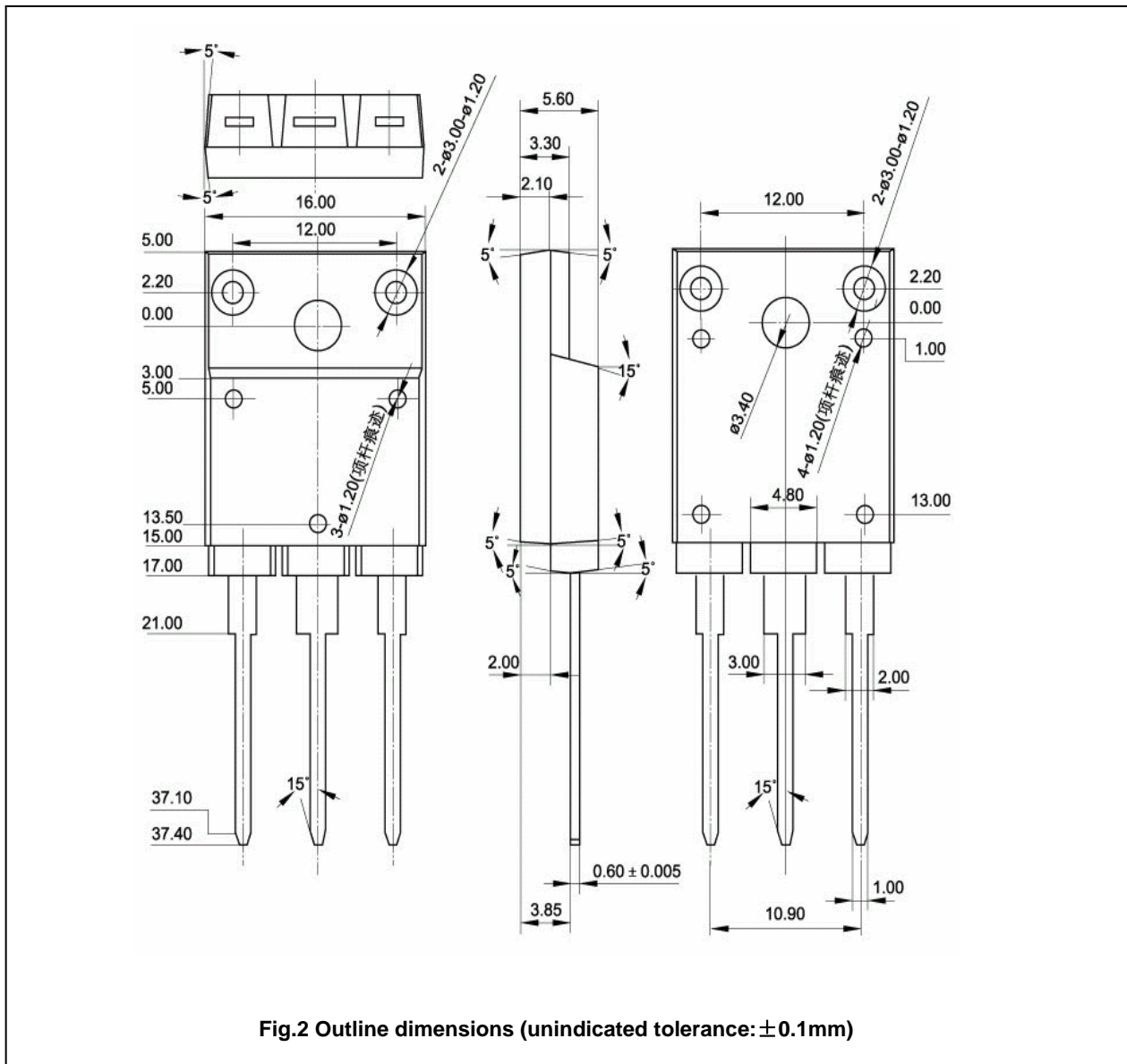

Fig.2 Outline dimensions (unindicated tolerance: ±0.1mm)

Silicon PNP Power Transistors

2SA1804

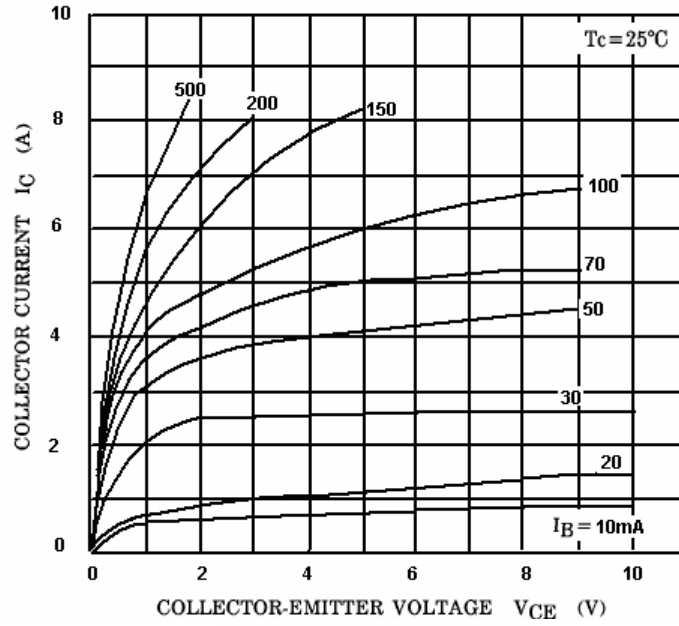

Fig.3 Static Characteristic

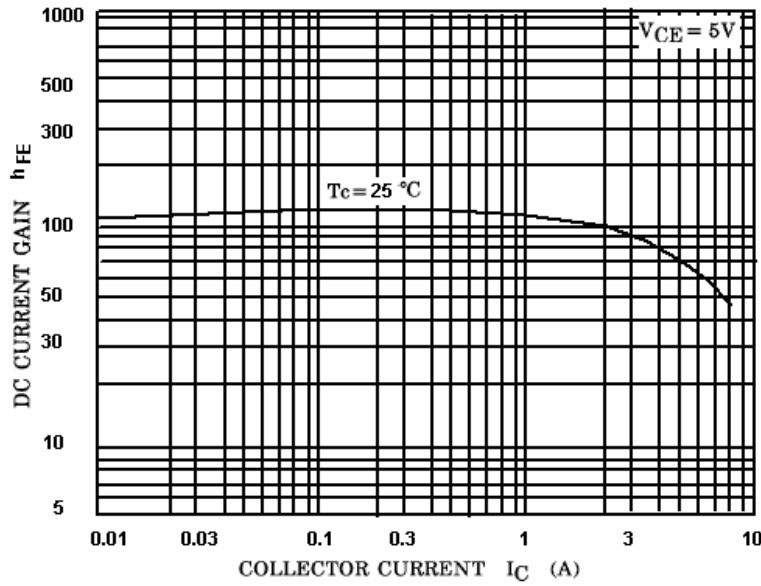

Fig.4 DC current Gain

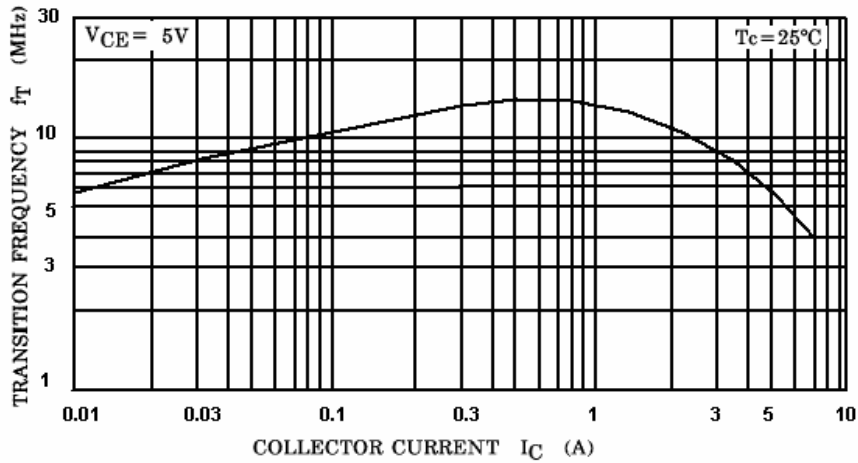

Fig.5  $f_T - I_C$

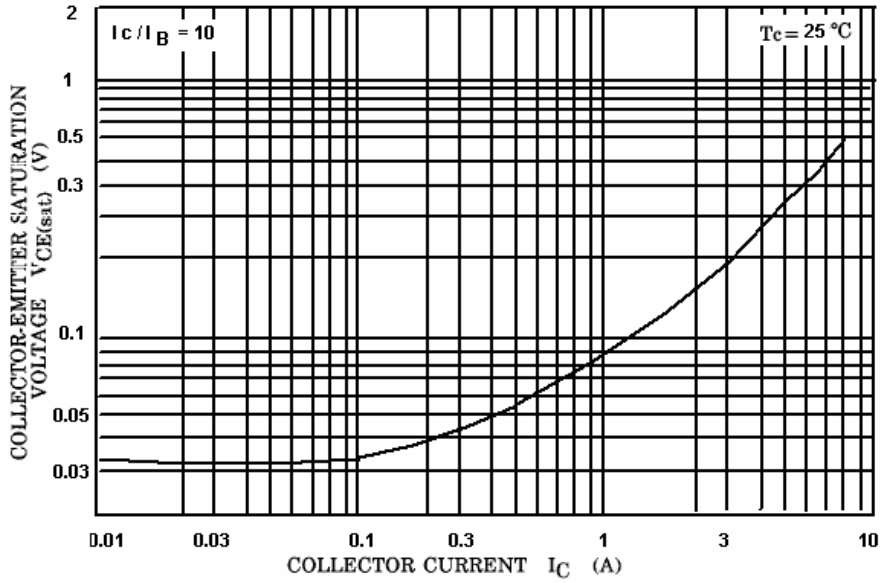

Fig.5 Collector-Emitter Saturation Voltage

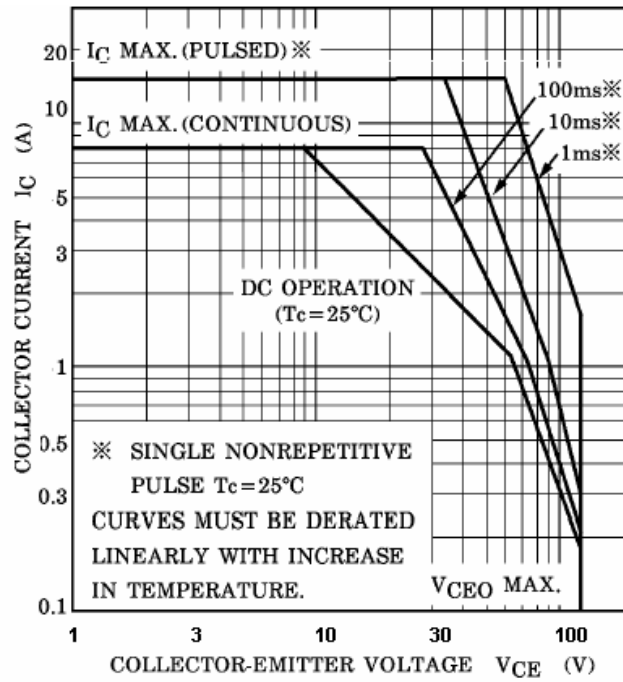

Fig.7 Safe Operating Area