

PRELIMINARY IN P/N DIR

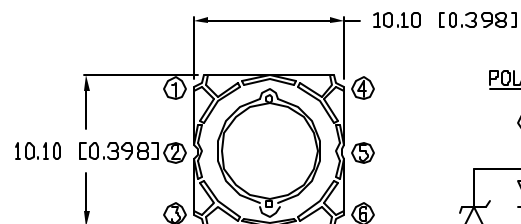

POLARITY:

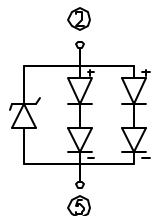

LEAD FREE REFLOW PROFILE

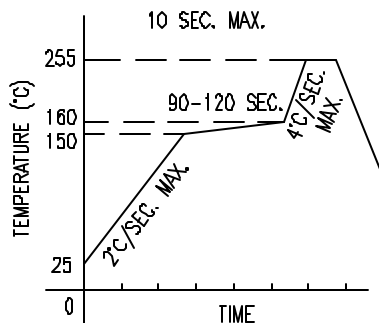

TOTAL TIME ABOVE 220°C IS 60 SECONDS MAX.

PAD LAYOUT:

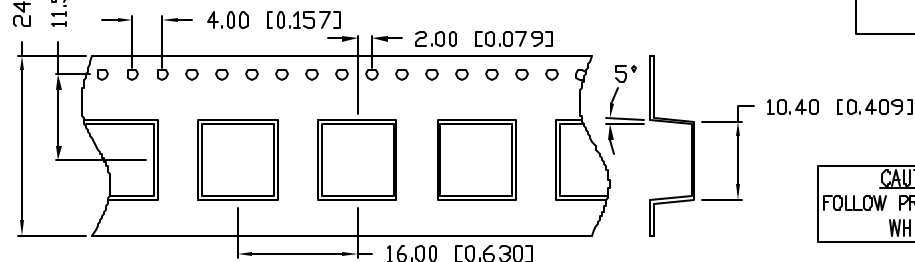
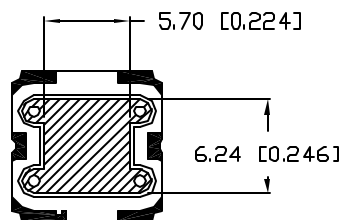
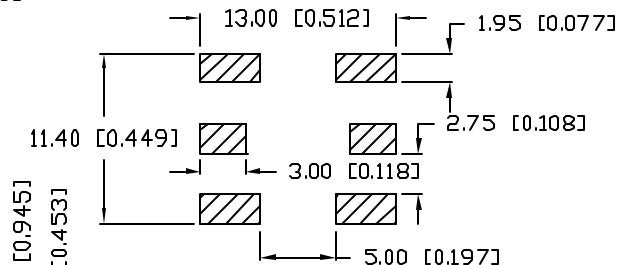
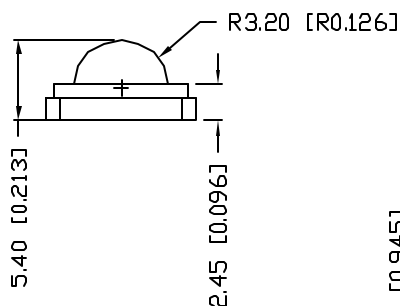

CAUTION: MOISTURE SENSITIVE DEVICE  
PER JEDEC LEVEL 3 STANDARDS

CAUTION: STATIC SENSITIVE DEVICE  
FOLLOW PROPER E.S.D. HANDLING PROCEDURES  
WHEN WORKING WITH THIS PART.



UNCONTROLLED DOCUMENT

\*UNLESS OTHERWISE SPECIFIED TOLERANCES PER DECIMAL PRECISION ARE: X=±1 (±0.039), X.X=±0.5 (±0.020), X.XX=±0.25 (±0.010), X.XXX=±0.127 (±0.005). LEAD SIZE=±0.05 (±0.002), LEAD LENGTH=±0.75 (±0.030), MIN.=<sup>+0.00</sup>/<sub>-0.00</sub> DECIMAL PRECISION, MAX.=<sup>+0.00</sup>/<sub>-0.00</sub> DECIMAL PRECISION

REV.

PART NUMBER

SML-LX3939UWC-TR

CONFIDENTIAL INFORMATION  
THE INFORMATION CONTAINED IN THIS DOCUMENT IS THE PROPERTY OF LUMEX INC. EXCEPT AS SPECIFICALLY AUTHORIZED IN WRITING BY LUMEX INC, THE HOLDER OF THIS DOCUMENT SHALL KEEP ALL INFORMATION CONTAINED HEREIN CONFIDENTIAL AND SHALL PROTECT SAME IN WHOLE OR IN PART FROM DISCLOSURE AND DISSEMINATION TO ALL THIRD PARTIES.



290 E. HELEN ROAD  
PALATINE, IL 60067-6976  
PHONE: +1.847.359.2790  
US WEB: www.lumex.com  
TW WEB: www.lumex.com.tw

10.10mm SQUARE 5 WATT HIGH POWER SMT LED,  
WHITE LED, WATER CLEAR LENS.

RELIABILITY NOTE  
OUR MANY YEARS OF EXPERIENCE DATA ACCUMULATION INDICATE THAT SOLDER HEAT IS A MAJOR CAUSE OF EARLY AND FUTURE FAILURE. PLEASE PAY ATTENTION TO YOUR SOLDERING PROCESS.

DRAWN BY:

CHECKED BY:

APPROVED BY:

DATE: 10.05.07

JN

PAGE: 1 OF 2  
SCALE: N/A