



N-Channel Enhancement Mode Field Effect Transistor

| PRODUCT SUMMARY | | |
|-----------------|----------------|------------------------------|
| V _{DS} | I _D | R _{DS(ON)} (mΩ) Max |
| 40V | 7A | 32 @ V _{GS} =10V |
| | | 45 @ V _{GS} =4.5V |

FEATURES

- Super high dense cell design for low R_{DS(ON)}.
- Rugged and reliable.
- Surface Mount Package.

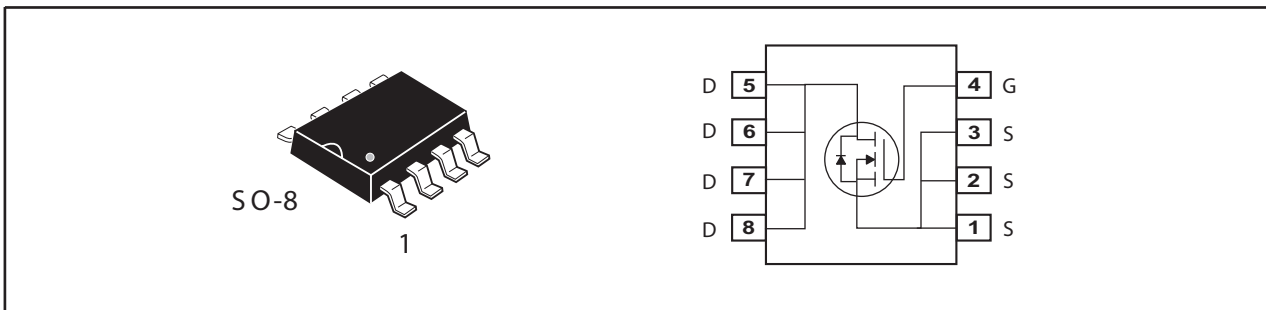

ABSOLUTE MAXIMUM RATINGS (T_A=25°C unless otherwise noted)

| Symbol | Parameter | Limit | Units |
|-----------------------------------|--|----------------------|-------|
| V _{DS} | Drain-Source Voltage | 40 | V |
| V _{GS} | Gate-Source Voltage | ±20 | V |
| I _D | Drain Current-Continuous ^a | T _A =25°C | 7 |
| | | T _A =70°C | 5.6 |
| I _{DM} | -Pulsed ^b | 28 | A |
| E _{AS} | Single Pulse Avalanche Energy ^d | 9 | mJ |
| P _D | Maximum Power Dissipation ^a | T _A =25°C | 2.5 |
| | | T _A =70°C | 1.6 |
| T _J , T _{STG} | Operating Junction and Storage Temperature Range | -55 to 150 | °C |

THERMAL CHARACTERISTICS

| | | | |
|------------------|--|----|------|
| R _{θJA} | Thermal Resistance, Junction-to-Ambient ^a | 50 | °C/W |
|------------------|--|----|------|

STM4460

Ver 1.0

ELECTRICAL CHARACTERISTICS (TA=25°C unless otherwise noted)

| Symbol | Parameter | Conditions | Min | Typ | Max | Units |
|---|---|---|-----|------|------|-------|
| OFF CHARACTERISTICS | | | | | | |
| BV _{DSS} | Drain-Source Breakdown Voltage | V _{GS} =0V, I _D =250uA | 40 | | | V |
| I _{DSS} | Zero Gate Voltage Drain Current | V _{DS} =32V, V _{GS} =0V | | | 1 | uA |
| I _{GSS} | Gate-Body Leakage Current | V _{GS} = ±20V, V _{DS} =0V | | | ±100 | nA |
| ON CHARACTERISTICS | | | | | | |
| V _{GS(th)} | Gate Threshold Voltage | V _{DS} =V _{GS} , I _D =250uA | 1 | 1.9 | 3 | V |
| R _{DS(ON)} | Drain-Source On-State Resistance | V _{GS} =10V, I _D =7A | | 26 | 32 | m ohm |
| | | V _{GS} =4.5V, I _D =6A | | 33 | 45 | m ohm |
| g _{FS} | Forward Transconductance | V _{DS} =10V, I _D =7A | | 16 | | S |
| DYNAMIC CHARACTERISTICS ^c | | | | | | |
| C _{ISS} | Input Capacitance | V _{DS} =20V, V _{GS} =0V f=1.0MHz | | 635 | | pF |
| C _{OSS} | Output Capacitance | | | 95 | | pF |
| C _{RSS} | Reverse Transfer Capacitance | | | 55 | | pF |
| SWITCHING CHARACTERISTICS ^c | | | | | | |
| t _{D(ON)} | Turn-On Delay Time | V _{DD} =20V I _D =7A | | 11 | | ns |
| t _r | Rise Time | | | 12 | | ns |
| t _{D(OFF)} | Turn-Off Delay Time | V _{GS} =10V R _{GEN} =3.3 ohm | | 17 | | ns |
| t _f | Fall Time | | | 11 | | ns |
| Q _g | Total Gate Charge | V _{DS} =20V, I _D =7A, V _{GS} =10V | | 11 | | nC |
| | | V _{DS} =20V, I _D =6A, V _{GS} =4.5V | | 5.1 | | nC |
| Q _{gs} | Gate-Source Charge | V _{DS} =20V, I _D =7A, V _{GS} =10V | | 1.7 | | nC |
| Q _{gd} | Gate-Drain Charge | | | 3 | | nC |
| DRAIN-SOURCE DIODE CHARACTERISTICS AND MAXIMUM RATINGS | | | | | | |
| I _S | Maximum Continuous Drain-Source Diode Forward Current | | | | 7 | A |
| V _{SD} | Diode Forward Voltage | V _{GS} =0V, I _S =7A | | 0.98 | 1.3 | V |
| Notes | | | | | | |
| a.Surface Mounted on FR4 Board, t ≤ 10sec. | | | | | | |
| b.Pulse Test:Pulse Width ≤ 300us, Duty Cycle ≤ 2%. | | | | | | |
| c.Guaranteed by design, not subject to production testing. | | | | | | |
| d.Starting T _J =25°C, L=0.5mH, R _G =25Ω, V _{DD} =20V.(See Figure 13) | | | | | | |

Jun,18,2008

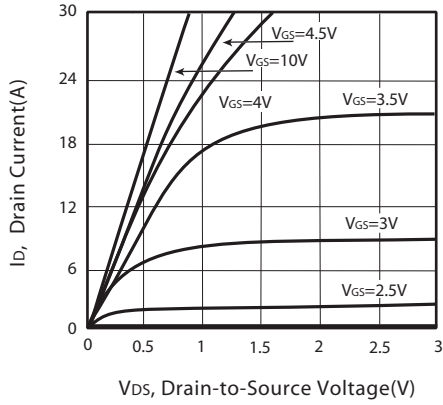

Figure 1. Output Characteristics

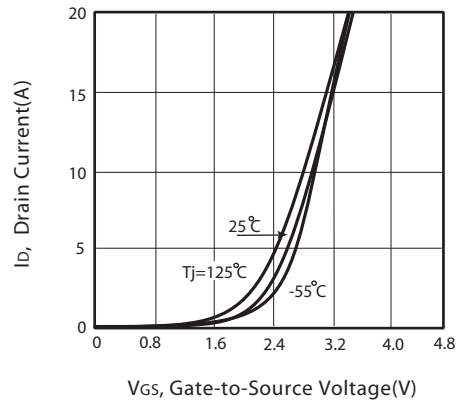

Figure 2. Transfer Characteristics

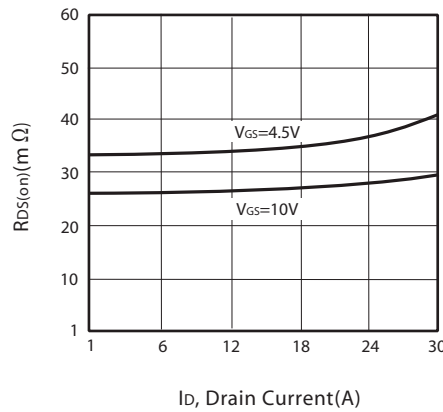

Figure 3. On-Resistance vs. Drain Current and Gate Voltage

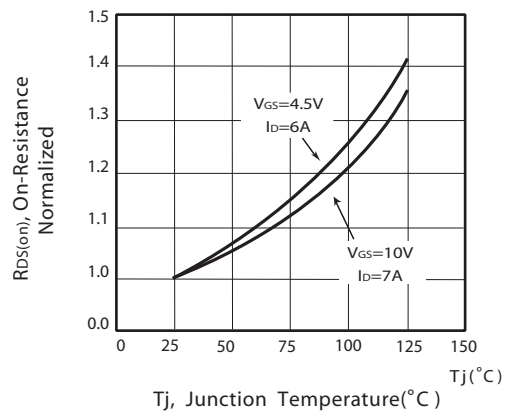

Figure 4. On-Resistance Variation with Drain Current and Temperature

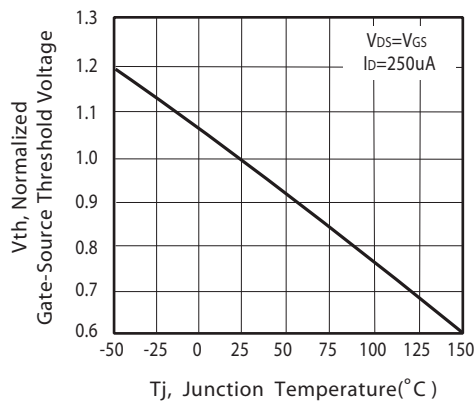

Figure 5. Gate Threshold Variation with Temperature

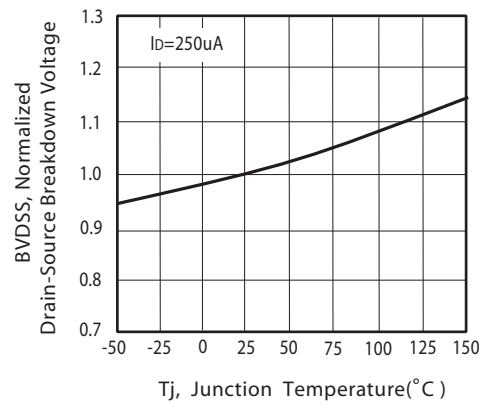

Figure 6. Breakdown Voltage Variation with Temperature

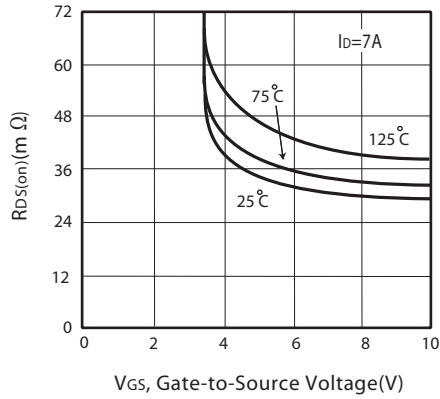

Figure 7. On-Resistance vs. Gate-Source Voltage

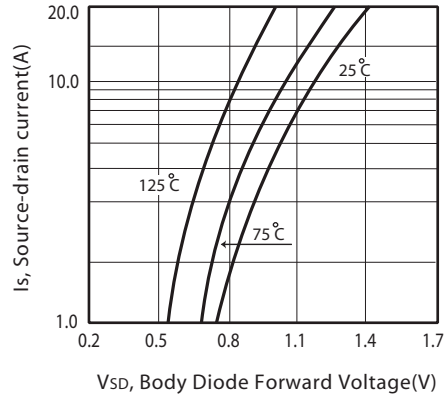

Figure 8. Body Diode Forward Voltage Variation with Source Current

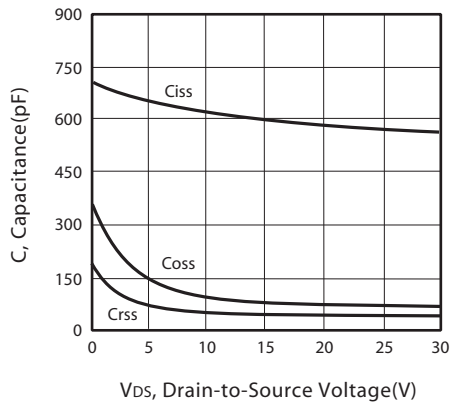

Figure 9. Capacitance

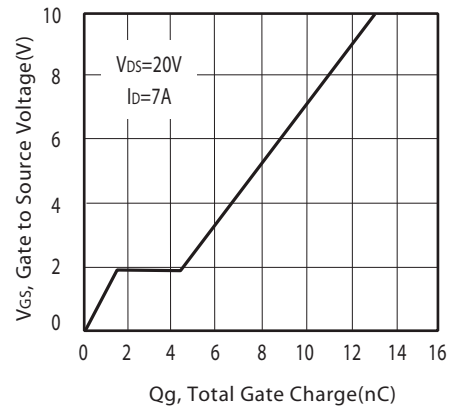

Figure 10. Gate Charge

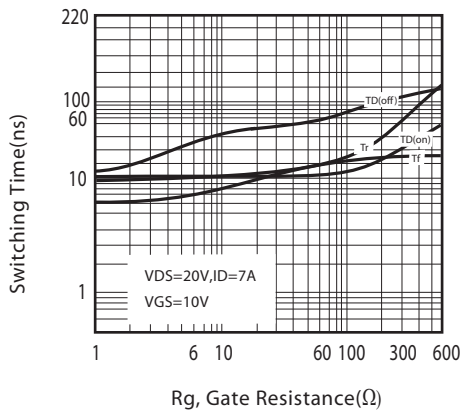

Figure 11. switching characteristics

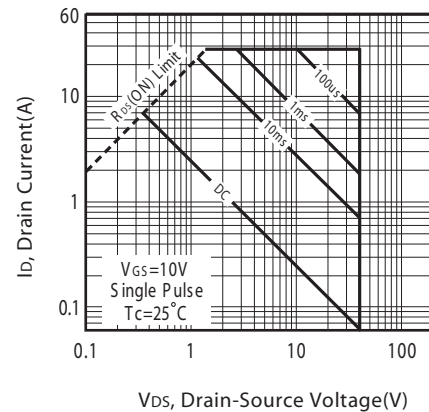
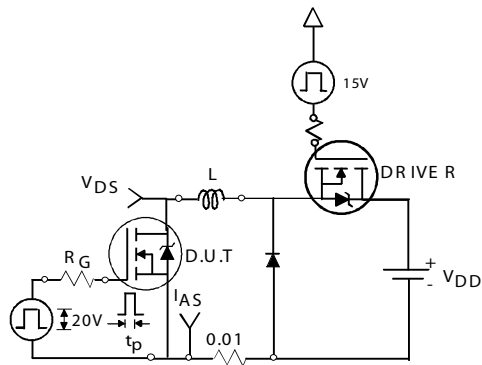
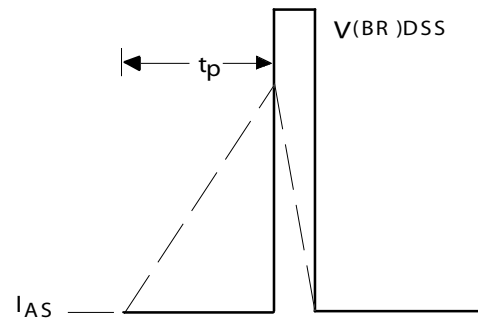

Figure 12. Maximum Safe Operating Area



Unclamped Inductive Test Circuit

Figure 13a.



Unclamped Inductive Waveforms

Figure 13b.

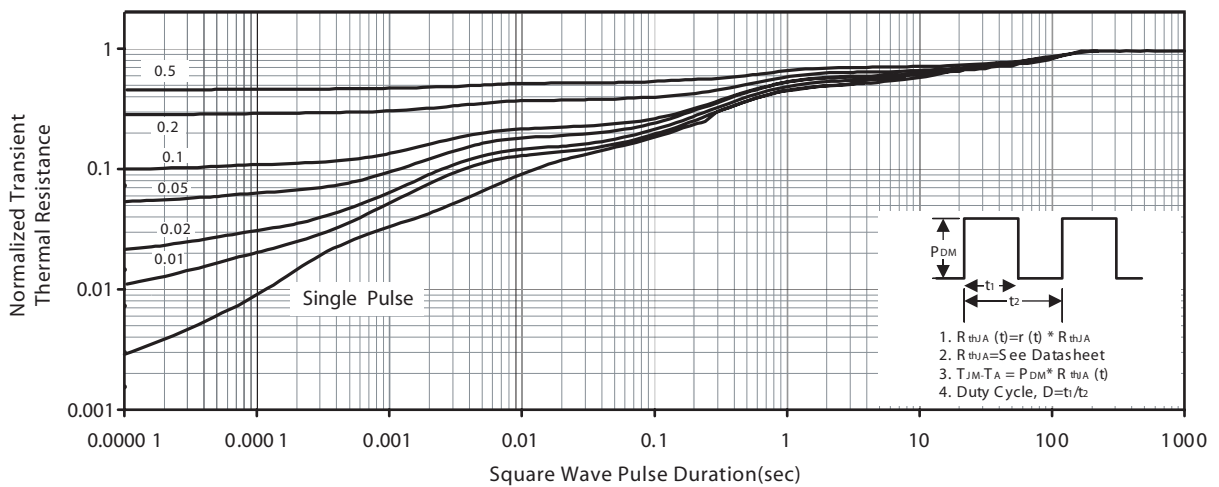
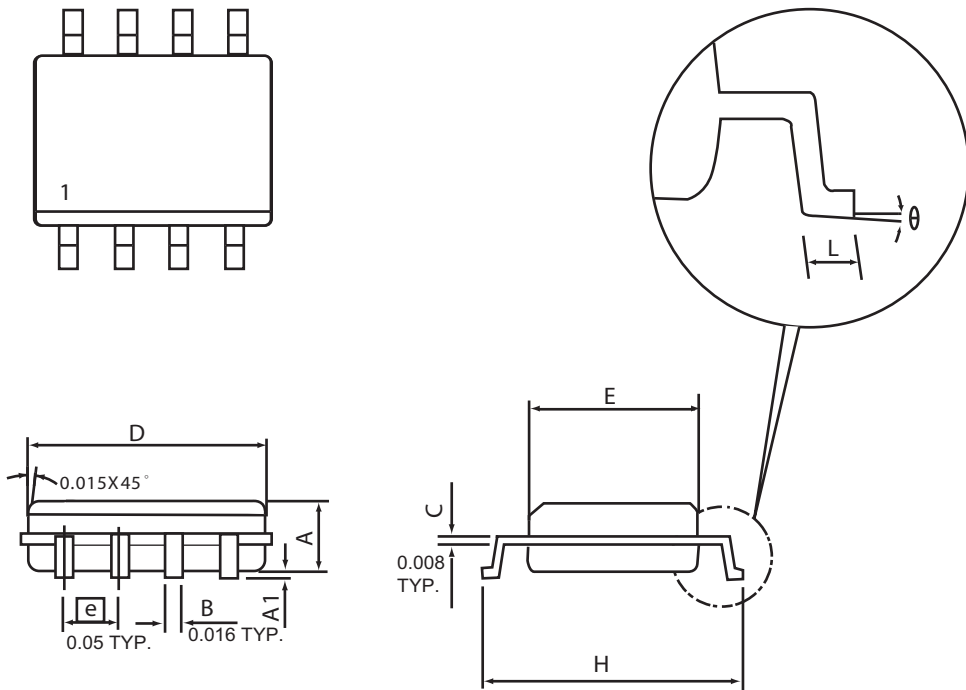

Figure 14. Normalized Thermal Transient Impedance Curve

PACKAGE OUTLINE DIMENSIONS

SO-8



| SYMBOLS | MILLIMETERS | | INCHES | |
|---------|-------------|------|--------|-------|
| | MIN | MAX | MIN | MAX |
| A | 1.35 | 1.75 | 0.053 | 0.069 |
| A1 | 0.10 | 0.25 | 0.004 | 0.010 |
| D | 4.80 | 4.98 | 0.189 | 0.196 |
| E | 3.81 | 3.99 | 0.150 | 0.157 |
| H | 5.79 | 6.20 | 0.228 | 0.244 |
| L | 0.41 | 1.27 | 0.016 | 0.050 |
| θ | 0° | 8° | 0° | 8° |

SO-8 Tape and Reel Data

SO-8 Carrier Tape

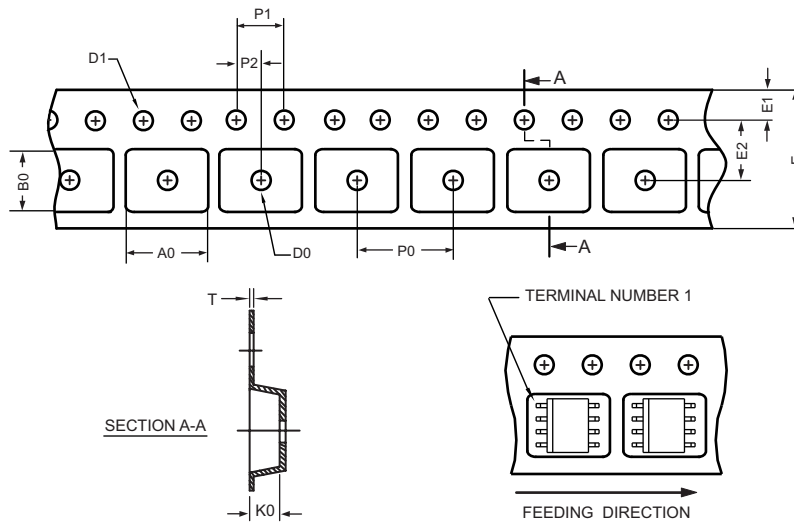

unit: mm

| PACKAGE | A0 | B0 | K0 | D0 | D1 | E | E1 | E2 | P0 | P1 | P2 | T |
|------------------|---------------|---------------|---------------|----------------|-----------------|----------------------|---------------|--------------|--------------|--------------|--------------|----------------|
| SOP 8N 150mil | 6.50 ±0.15 | 5.25 ±0.10 | 2.10 ±0.10 | φ 1.5 (MIN) | φ 1.55 ±0.10 | 12.0 +0.3 -0.1 | 1.75 ±0.10 | 5.5 ±0.10 | 8.0 ±0.10 | 4.0 ±0.10 | 2.0 ±0.10 | 0.30 ±0.013 |

SO-8 Reel

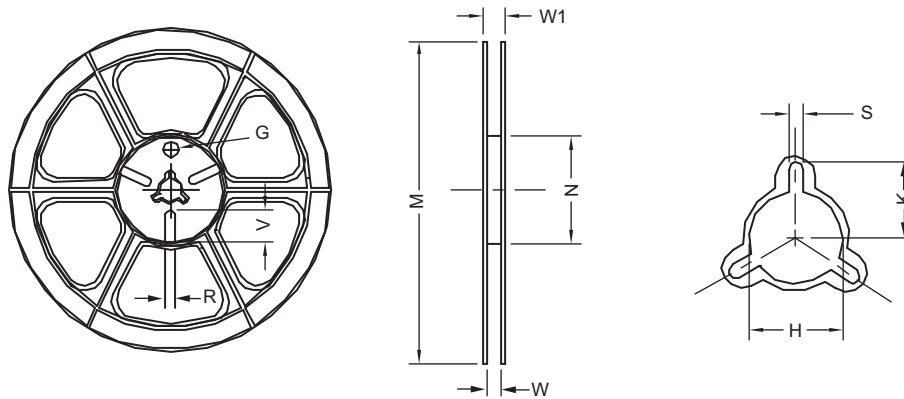

UNIT: mm

| TAPE SIZE | REEL SIZE | M | N | W | W1 | H | K | S | G | R | V |
|-----------|-----------|------------|------------|---------------|---------------|-------------------|-----|--------------|-----|-----|-----|
| 12 mm | φ 330 | 330 ± 1 | 62 ±1.5 | 12.4 + 0.2 | 16.8 - 0.4 | φ 12.75 + 0.15 | --- | 2.0 ±0.15 | --- | --- | --- |