

## Wirewound Rheostat/Potentiometer

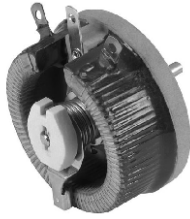

### FEATURES

- 55 W at 25 °C
- 40 W at 25 °C
- CCTU 05-03B (PA3)



**RoHS**  
COMPLIANT

### DIMENSIONS in millimeters

#### ADAPTATION BOARD

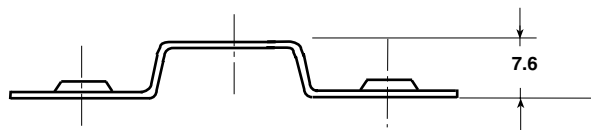

#### PANEL CUT OUT DETAILS

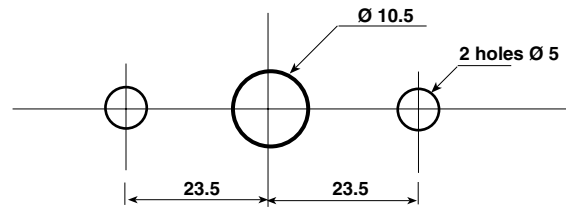

RT55-PA3

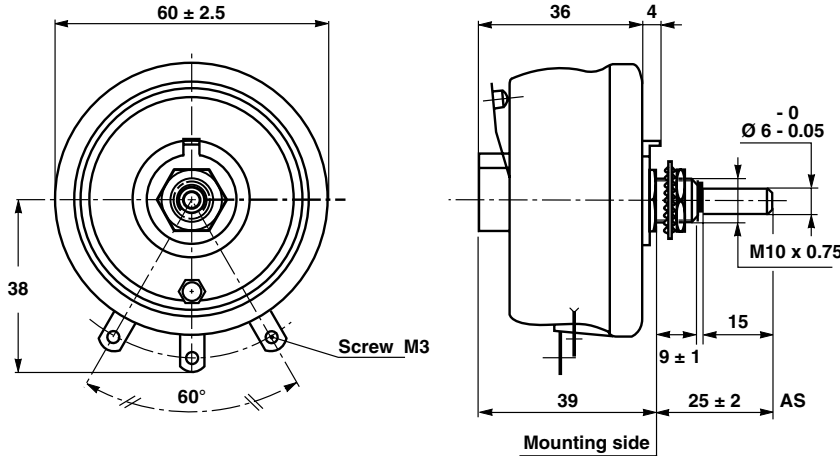

#### PANEL CUT OUT DETAILS

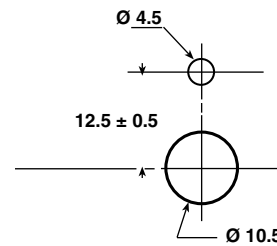

### MECHANICAL SPECIFICATIONS

Mechanical Protection	Vitreous
Mechanical Travel	300° ± 5°
Operating Torque	2 to 15 Ncm
End Stop Torque	100 Ncm
Unit Weight	175 g

### ENVIRONMENTAL SPECIFICATIONS

Temperature Range	- 55 °C + 320 °C
Climatic Category	CCTU 454 CEI 55/200/56

ELECTRICAL SPECIFICATIONS	
Ohmic Range	1Ω to 10 kΩ
Tolerance Standard	± 10 %
Power Rating	55 W at 25 °C
Variation Law	Standard: linear
	On request: sectorial winding
Limiting Element Voltage	500 V (linear Law)
Dielectric Strength	1000 V <sub>RMS</sub>
Insulation Resistance	10 <sup>3</sup> MΩ (500 V <sub>CC</sub> )

**LOCKING DEVICE**

This is supplied as an option. The available spindle length is according to the panel thickness.  
Order reference: DBA6

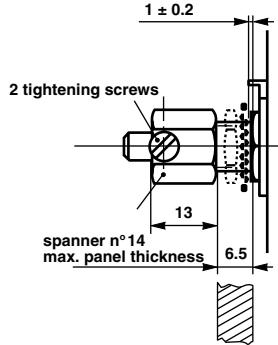

**ADAPTATION BOARD**

This enables 2 point mounting instead of bush mounting. The adaptation board is supplied as an option with 2 mounting screws.

SPINDLES			
Ø mm	DISTANCE TO MOUNTING PLATE mm	SCREW DRIVER SLOT	CODE
6	22	WITHOUT	AD
		WITH	ADF
	25	WITHOUT	AS
		WITH	ASF
50	WITHOUT	AL	

For any special requirement on request: spindle flats, etc.  
Please supply detailed drawing.

**COMMAND KNOB 41JF (OPTION)**

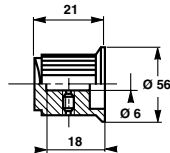

**DIAL CG78 (OPTION)**

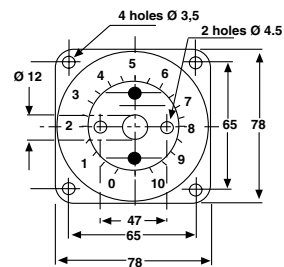

**MARKING**

SFERNICE trademark, series, style, ohmic value (in Ω or kΩ), tolerance (in %), maximum current in A, manufacturing date

ORDERING INFORMATION											
VITREOUS	RT	55	L	AS	4K7	± 10 %	B01	e			
	SERIES	STYLE	SPINDLE LOCKING DEVICE	VARIATION LAW	SPECIAL DESIGN	WINDING	SPINDLE (Code)	OHMIC VALUE	TOLERANCE	PACKAGING	LEAD (Pb)-FREE
			Optional		Method N° Optional	Optional	for special spindles please supply detailed drawing				
		ACC	BOUTON CADIAN	CG78 41JF	e						
ACCESORIES	MODEL		TYPE	STYLE	LEAD (Pb)-FREE						

PARTICULAR CHARACTERISTICS		
NOMINAL RESISTANCE Ω	MAX. SERVICE VOLTAGE V	MAX. CURRENT THROUGH WIPER A
1	7.41	7.41
1.5	9.08	6.05
2.2	11	5
3.3	4.7	6.8
4.7	16.1	3.42
6.8	19.3	2.84
10	23.5	2.35
15	28.7	1.91
22	34.8	1.58
33	42.6	1.29
47	50.8	1.08
68	61.2	0.9
100	74.1	0.74
150	90.8	0.6
220	110	0.5
330	135	0.4
470	161	0.34
680	193	0.28
1K	235	0.23
1.5K	287	0.19
2.2K	348	0.16
3.3K	426	0.13
4.7K	500	0.11
5.6K	500	0.09
10K	500	0.05



**SAP PART NUMBERING GUIDELINES**

<b>RT</b> MODEL	<b>055</b> STYLE	<b>AS</b> SPINDLE	<b>4701</b> OHMIC VALUE	<b>K</b> TOLERANCE	<b>B</b> PACKAGING	<b>XXX</b> SPECIAL DESIGN
<b>ACCRF</b> MODEL		<b>BOUTON</b> TYPE			<b>41JF</b> STYLE	



## Disclaimer

All product specifications and data are subject to change without notice.

Vishay Intertechnology, Inc., its affiliates, agents, and employees, and all persons acting on its or their behalf (collectively, "Vishay"), disclaim any and all liability for any errors, inaccuracies or incompleteness contained herein or in any other disclosure relating to any product.

Vishay disclaims any and all liability arising out of the use or application of any product described herein or of any information provided herein to the maximum extent permitted by law. The product specifications do not expand or otherwise modify Vishay's terms and conditions of purchase, including but not limited to the warranty expressed therein, which apply to these products.

No license, express or implied, by estoppel or otherwise, to any intellectual property rights is granted by this document or by any conduct of Vishay.

The products shown herein are not designed for use in medical, life-saving, or life-sustaining applications unless otherwise expressly indicated. Customers using or selling Vishay products not expressly indicated for use in such applications do so entirely at their own risk and agree to fully indemnify Vishay for any damages arising or resulting from such use or sale. Please contact authorized Vishay personnel to obtain written terms and conditions regarding products designed for such applications.

Product names and markings noted herein may be trademarks of their respective owners.