

## FEATURES

- $-55^{\circ}\text{C}$  to  $+125^{\circ}\text{C}$  operation
- 50 dB min. attenuation at 500 kHz differential mode
- 45 dB min. attenuation at 5MHz common mode
- Compliant to MIL-STD-461C, CE03
- Compatible with MIL-STD-704A through E

# EMI INPUT FILTER 28 VOLT INPUT SURFACE MOUNT

## FMGA EMI FILTER 0.8 AMP

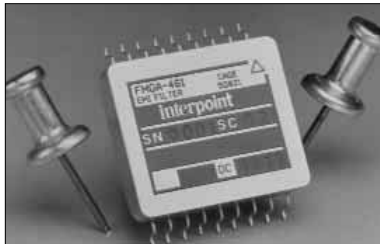

MODEL	
FMGA-461	0.8 amp

Size (max.): 1.010 x 0.880 x 0.250 inches (25.65 x 22.35 x 6.35 mm)  
Shown with "Gull Wing" lead option, also available with straight leads. See Section B8, case B, for dimensions and options.  
Weight: 10.3 grams typical, 11.5 grams maximum  
Screening: Standard or ES. See Section C2 for screening options, see Section A5 for ordering information.

## DESCRIPTION

Interpoint's surface mount FMGA-461™ EMI filter has been designed to work with Interpoint's surface mount MGA and MGH Series DC/DC converters. Multiple MGA or MGH Series converters can be operated from a single FMGA filter provided the total power line current does not exceed the filter's maximum rating. The FMGA filter will reduce the converter's power line reflected ripple current to within the limit of MIL-STD-461C, Method CE03 as shown in Figures 4 through 7. The filter uses only ceramic capacitors for reliable high-temperature operation.

## CONNECTION AND OPERATION

Where more than one pin has the same designation (e.g. pins 7, 8, and 9 are Positive Output), all of those pins must be connected for output performance to meet the specifications.

The MGA Series has an internal 2  $\mu\text{F}$  capacitor its input terminals and the MGH Series has an internal 0.47  $\mu\text{F}$  capacitor across its input power terminals. When the MGA or MGH converters are used with the FMGA filter, this capacitor becomes part of the filter and forms its final LC output section. When 2 or 3 MGA or MGH converters are used with a single filter, this capacitor becomes larger, improving the rejection versus frequency.

## TRANSIENT DAMPING

The optional damping circuit shown in Figure 2 will prevent filter overshoot caused by 80 V transients with rise times of less than 200

microseconds. The damping circuit can be used with a 1.50  $\Omega$  resistor in series with the filter's positive input where the additional line loss can be tolerated. For transients with rise times of greater than 200 microseconds, there is no overshoot and the damping circuit is not required.

## SURFACE MOUNT PACKAGE

The FMGA EMI filter can be surface mounted with pick-and-place equipment or manually. It is recommended that the case be attached with flexible epoxy adhesive or silicone which is thermally conductive ( $>1$  watt /meter<sup>2</sup>K).

Internal components are soldered with SN96 (melting temperature 221°C) to prevent damage during reflow. Maximum reflow temperature for surface mounting the FMGA filter is 220°C for a maximum of 30 seconds. SN60, 62, or 63 are the recommended types of solder. Hand soldering should not exceed 300°C for 10 seconds per pin.

The hermetically sealed metal cases are available in two different lead configurations. See Section B8, case B.

## LAYOUT REQUIREMENTS

The case of the filter must be connected to the case of the converter through a low impedance connection to minimize EMI.

CRANE

interpoint

A CRANE CO. COMPANY

# FMGA EMI FILTER 0.8 AMP

# EMI INPUT FILTERS

ABSOLUTE MAXIMUM RATINGS	
<b>Input Voltage</b>	<ul style="list-style-type: none"> <li>0 to 40 VDC continuous</li> <li>80 V for 100 ms transient</li> </ul>
<b>Lead Soldering Temperature (10 sec per lead)</b>	<ul style="list-style-type: none"> <li>300°C</li> </ul>
<b>Storage Temperature Range (Case)</b>	<ul style="list-style-type: none"> <li>-65°C to +150°C</li> </ul>

RECOMMENDED OPERATING CONDITIONS	
<b>Input Voltage Range</b>	<ul style="list-style-type: none"> <li>16 to 40 VDC continuous</li> </ul>
<b>Case Operating Temperature (Tc)</b>	<ul style="list-style-type: none"> <li>-55°C to +125°C full power</li> </ul>
<b>Derating Input and Output Current</b>	<ul style="list-style-type: none"> <li>Derate linearly from 100% at 100°C to 0.60 Amps at 125°C case. Above 125°C derate to 0%</li> </ul>

TYPICAL CHARACTERISTICS	
<b>Capacitance</b>	<ul style="list-style-type: none"> <li>0.045 μF max, any pin to case</li> </ul>
<b>Isolation</b>	<ul style="list-style-type: none"> <li>100 megohm minimum at 500 V</li> <li>Any pin to case, except case pin</li> </ul>

Electrical Characteristics: 25°C Tc, nominal Vin, unless otherwise specified.

PARAMETER	CONDITIONS	FMGA-461			UNITS
		MIN	TYP	MAX	
INPUT VOLTAGE	CONTINUOUS	0	28	40	VDC
	TRANSIENT 100 ms	—	—	80	V
INPUT CURRENT		—	—	0.80	A
DIFFERENTIAL MODE NOISE REJECTION	500 kHz	50	—	—	dB
COMMON MODE NOISE REJECTION	5 MHz	45	—	—	
DIFFERENTIAL MODE NOISE REJECTION	2 MHz - 50 MHz	40	—	—	dB
DC RESISTANCE (R <sub>DC</sub> )	TC = 25°C	—	—	1.50	Ω
OUTPUT VOLTAGE	STEADY STATE	$V_{OUT} = V_{IN} \cdot I_N (R_{DC})$			VDC
OUTPUT CURRENT	STEADY STATE (<100°C CASE)	—	—	0.80	A
INTERNAL POWER DISSIPATION	MAXIMUM CURRENT	—	—	1.37	W

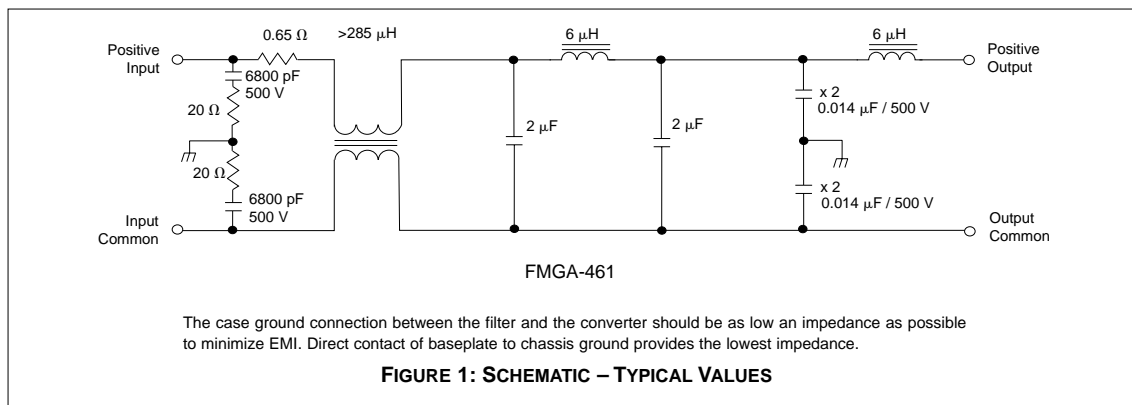

# EMI INPUT FILTERS

# FMGA EMI FILTER 0.8 AMP

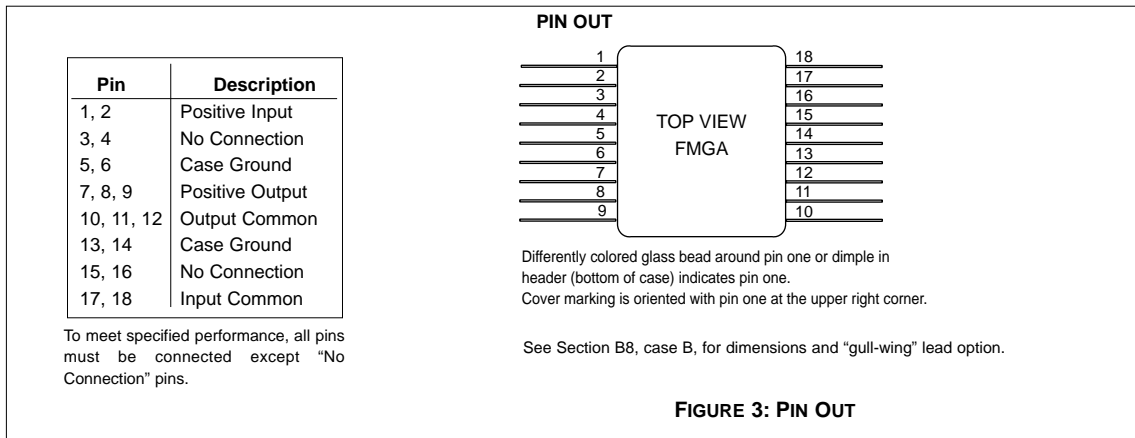
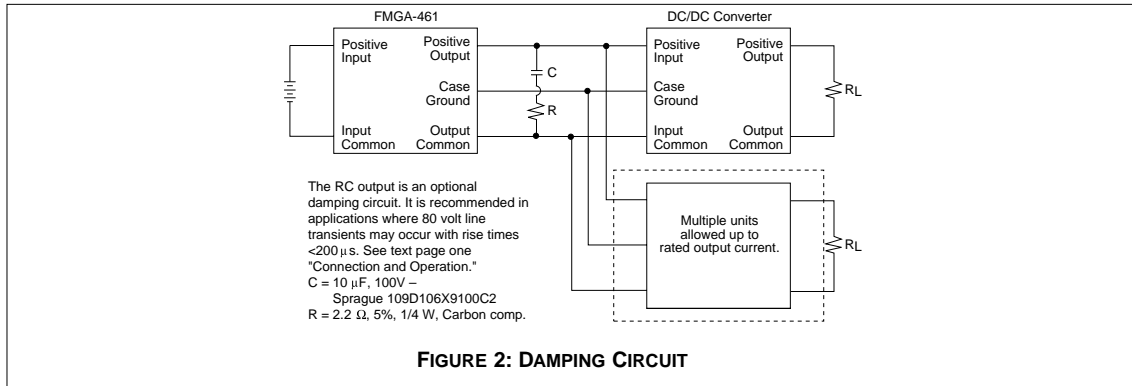

DSCC NUMBER	
DSCC DRAWING (5915)	FMGA-461 FILTER SIMILAR PART
IN PROCESS	FMGA-461/883

For exact specifications for a DSCC product, refer to the DSCC drawing. Call you Interpoint representative for status on the FMGA DSCC models. See Section A3, "SMD/DSCC Lists", for more information.

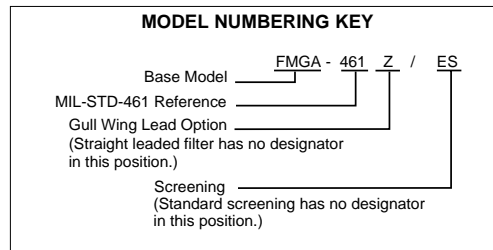

# FMGA EMI FILTER 0.8 AMP

# EMI INPUT FILTERS

Typical Performance Curves: 25°C Tc , nominal Vin, unless otherwise specified.

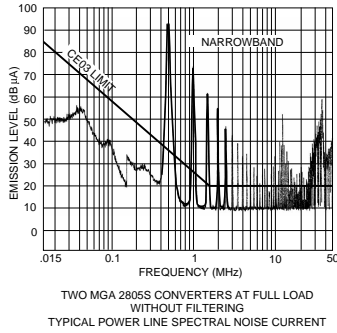

FIGURE 4

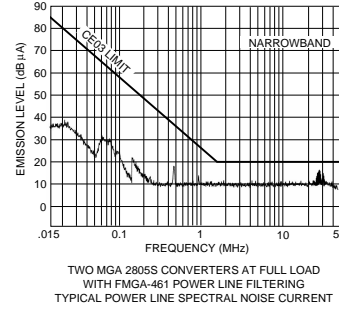

FIGURE 5

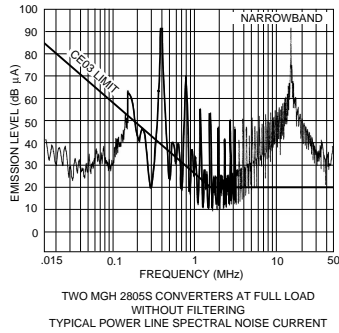

FIGURE 6

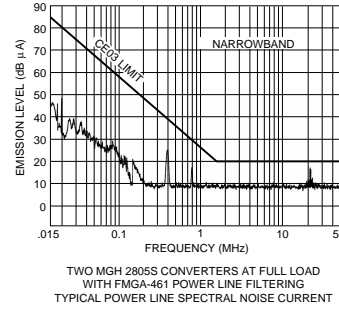
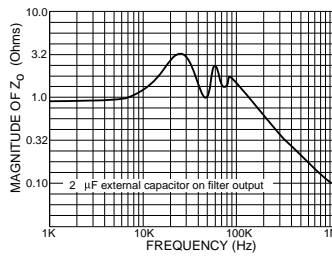

FIGURE 7



Typical Output Impedance (Z)  
With Input Shorted

FIGURE 8

26221-001-DTS RevA  
DQ# 4011  
FMGA-461 is a trademark of Interpoint.  
© Interpoint 1999

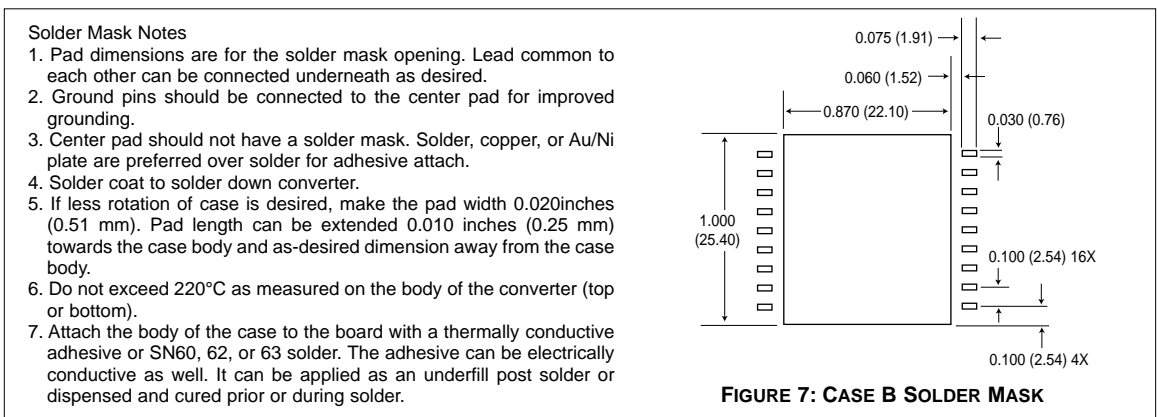
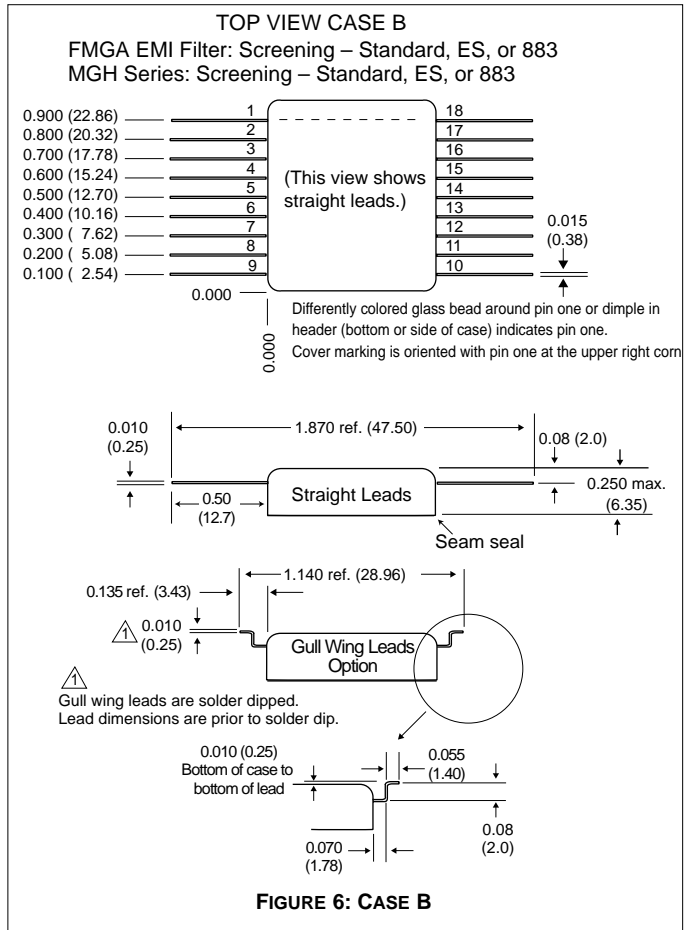
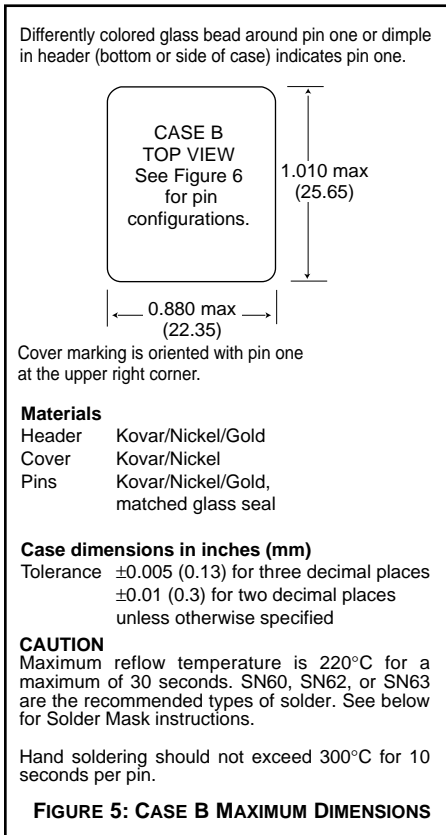

Note: Although every effort has been made to render the case drawings at actual size, variations in the printing process may cause some distortion. Please refer to the numerical dimensions for accuracy.

**QA SCREENING  
125°C PRODUCTS**

**125°C PRODUCTS**

<b>TEST (125°C Products)</b>	<b>STANDARD</b>	<b>/ES</b>	<b>/883 (Class H)*</b>
PRE-CAP INSPECTION Method 2017, 2032	yes	yes	yes
TEMPERATURE CYCLE (10 times) Method 1010, Cond. C, -65°C to 150°C Method 1010, Cond. B, -55°C to 125°C	no no	no yes	yes no
CONSTANT ACCELERATION Method 2001, 3000 g Method 2001, 500 g	no no	no yes	yes no
BURN-IN Method 1015, 160 hours at 125°C 96 hours at 125°C case (typical)	no no	no yes	yes no
FINAL ELECTRICAL TEST MIL-PRF-38534, Group A Subgroups 1 through 6: -55°C, +25°C, +125°C Subgroups 1 and 4: +25°C case	no yes	no yes	yes no
HERMETICITY TESTING Fine Leak, Method 1014, Cond. A Gross Leak, Method 1014, Cond. C Gross Leak, Dip (1 x 10 <sup>-3</sup> )	no no yes	yes yes no	yes yes no
FINAL VISUAL INSPECTION Method 2009	yes	yes	yes

Test methods are referenced to MIL-STD-883 as determined by MIL-PRF-38534.

\*883 products are built with element evaluated components and are 100% tested and guaranteed over the full military temperature range of -55°C to +125°C.

Applies to the following products

MOR Series	MHD Series	MGH Series	FMGA EMI Filter
MFLHP Series	MHV Series	MCH Series	FMSA EMI Filter
MFL Series	MHF+ Series	FM-704A EMI Filter	HUM Modules**
MHP Series	MHF Series**	FMD**/FME EMI Filter	LCM Modules**
MTR Series	MGA Series	FMC EMI Filter	LIM Modules
MQO Series**	MSA Series	FMH EMI Filter	

\*\*MFLHP Series, MQO Series, MHF Series, FMD EMI Filters, Hum Modules, and LCM Modules do not offer '883' screening.