

**Silicon PNP Power Transistors**

**2SA1907**

**DESCRIPTION**

- With TO-3PML package
- Complement to type 2SC5099

**APPLICATIONS**

- Audio and general purpose

**PINNING**

PIN	DESCRIPTION
1	Emitter
2	Collector
3	Base

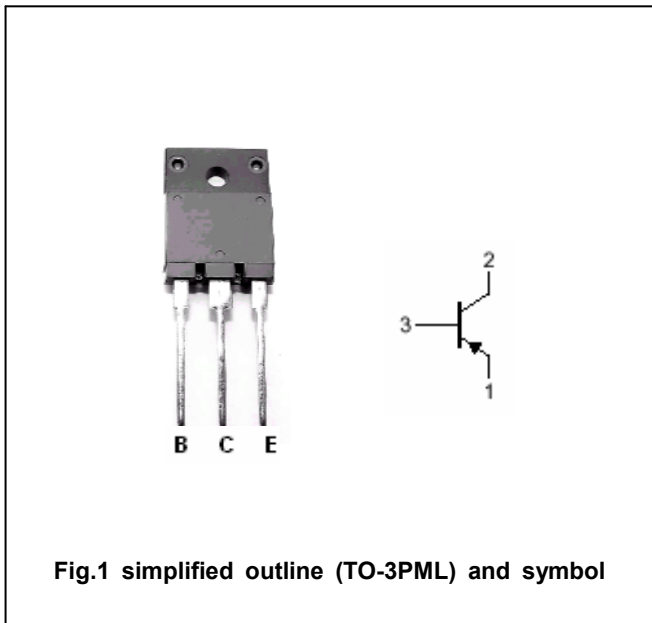

Fig.1 simplified outline (TO-3PML) and symbol

**Absolute maximum ratings(Tc=25°C)**

SYMBOL	PARAMETER	CONDITIONS	VALUE	UNIT
V <sub>CBO</sub>	Collector-base voltage	Open emitter	-80	V
V <sub>CEO</sub>	Collector-emitter voltage	Open base	-80	V
V <sub>EBO</sub>	Emitter-base voltage	Open collector	-6	V
I <sub>C</sub>	Collector current		-6	A
I <sub>B</sub>	Base current		-3	A
P <sub>C</sub>	Collector power dissipation	T <sub>C</sub> =25°C	60	W
T <sub>j</sub>	Junction temperature		150	°C
T <sub>stg</sub>	Storage temperature		-55~150	°C

## Silicon PNP Power Transistors

## 2SA1907

## CHARACTERISTICS

T<sub>j</sub>=25 °C unless otherwise specified

SYMBOL	PARAMETER	CONDITIONS	MIN	TYP.	MAX	UNIT
V <sub>(BR)CEO</sub>	Collector-emitter breakdown voltage	I <sub>C</sub> =-50mA; I <sub>B</sub> =0	-80			V
V <sub>CEsat</sub>	Collector-emitter saturation voltage	I <sub>C</sub> =-2A; I <sub>B</sub> =-0.2 A			-0.5	V
I <sub>CBO</sub>	Collector cut-off current	V <sub>CB</sub> =-80V; I <sub>E</sub> =0			-10	μA
I <sub>EBO</sub>	Emitter cut-off current	V <sub>EB</sub> =-6V; I <sub>C</sub> =0			-10	μA
h <sub>FE</sub>	DC current gain	I <sub>C</sub> =-2A ; V <sub>CE</sub> =-4V	50		180	
f <sub>T</sub>	Transition frequency	I <sub>C</sub> =-0.5A ; V <sub>CE</sub> =-12V		20		MHz
C <sub>OB</sub>	Output capacitance	I <sub>E</sub> =0; V <sub>CB</sub> =10V; f=1MHz		150		pF

## Switching times

t <sub>on</sub>	Turn-on time	I <sub>C</sub> =-3A; R <sub>L</sub> =10Ω I <sub>B1</sub> =-I <sub>B2</sub> =-0.3A; V <sub>CC</sub> =-30V		0.18		μs
t <sub>s</sub>	Storage time			1.10		μs
t <sub>f</sub>	Fall time			0.21		μs

◆ h<sub>FE</sub> classifications

O	P	Y
50-100	70-140	90-180

Silicon PNP Power Transistors

2SA1907

PACKAGE OUTLINE

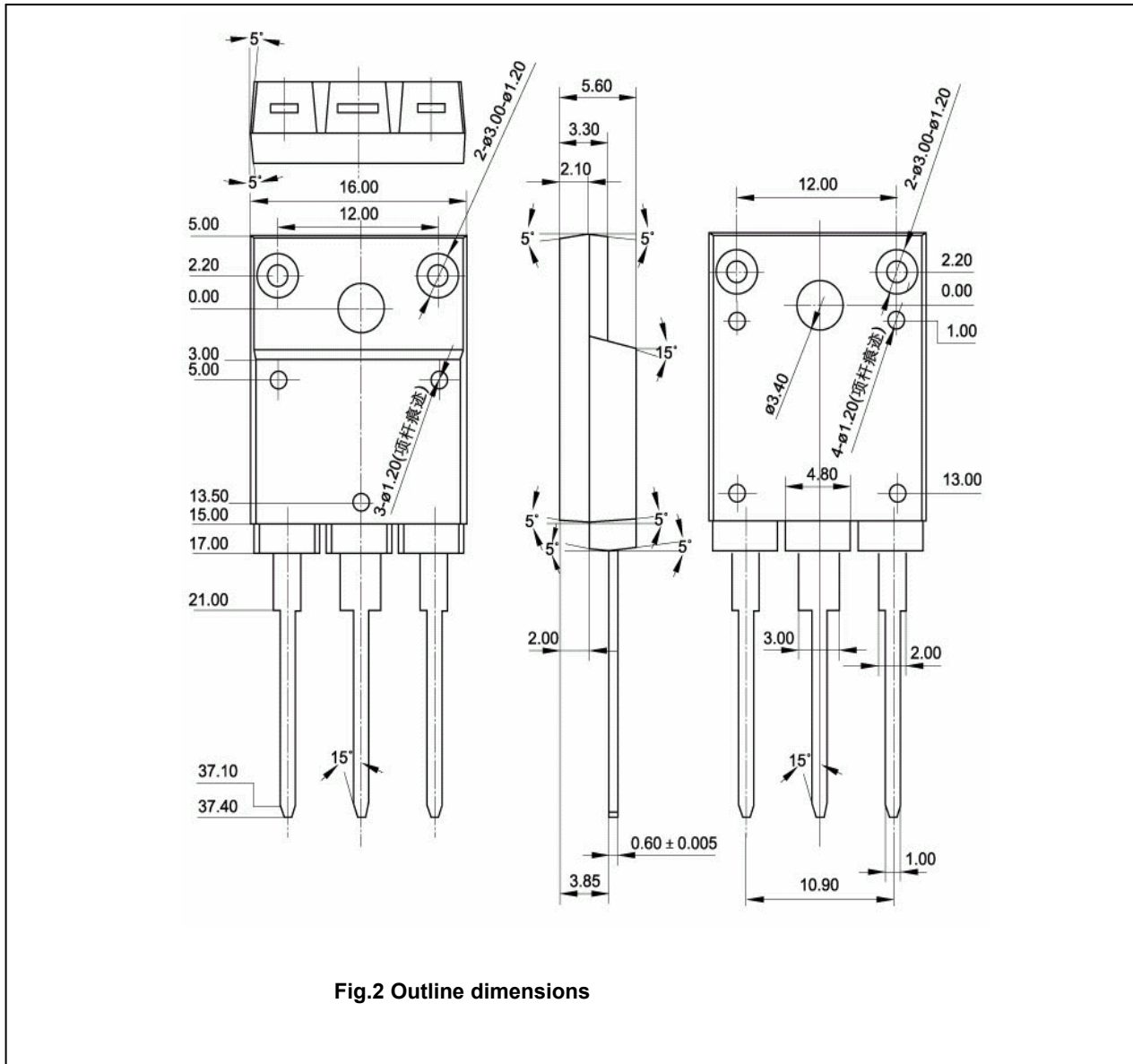

Fig.2 Outline dimensions

Silicon PNP Power Transistors

2SA1907

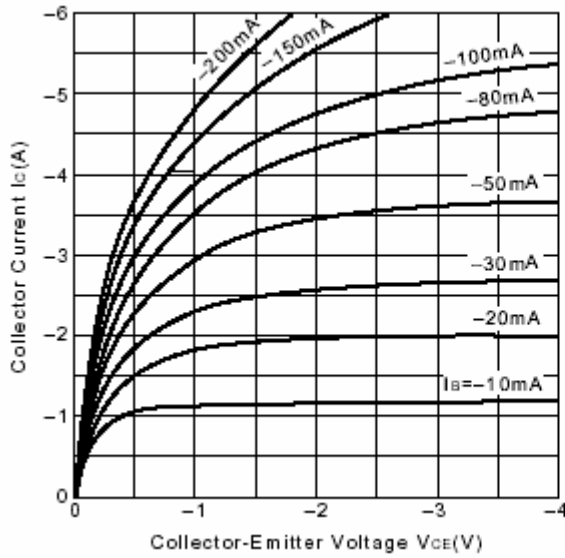

Fig.3 Static Characteristic

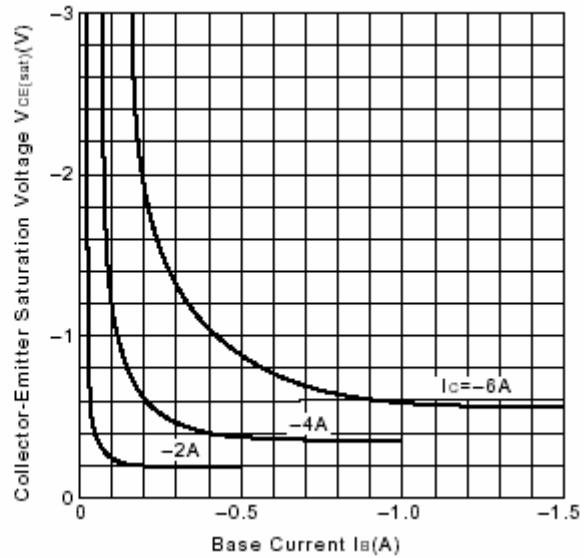

Fig.4  $V_{CE(sat)}-I_B$  Characteristics

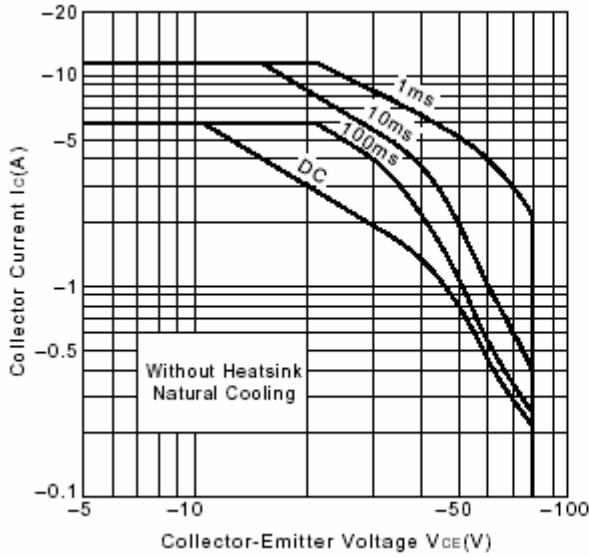

Fig.5 Safe Operating Area

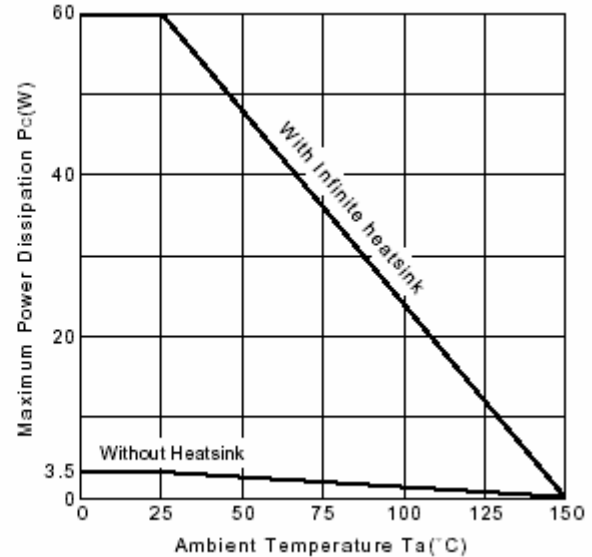

Fig.6  $P_c-T_a$  Derating

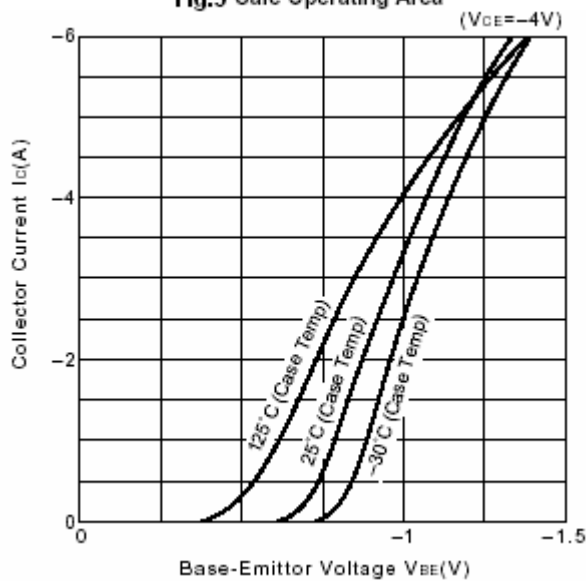

Fig.7  $I_C-V_{BE}$

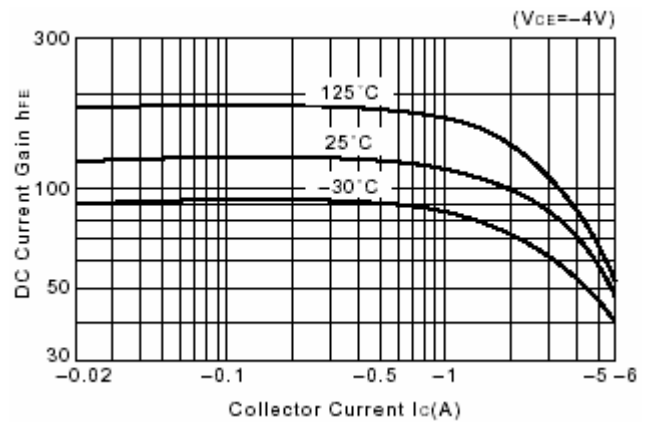

Fig.8 DC current Gain