

L6562A 400W FOT-controlled PFC pre-regulator evaluation board

Data Brief

Features

- Line voltage range: 90 to 265 V_{ac}
- Minimum line frequency (fL): 47 Hz
- Regulated output voltage: 400 V
- Rated output power: 400 W
- Maximum 2fL output voltage ripple: 10 V pk-pk
- Hold-up time: 22 ms
(V_{DROP} after hold-up time: 300 V)
- Maximum switching frequency: 85 kHz
(@V_{in}= 90 V_{ac}, P_{out}= 400 W)
- Minimum estimated efficiency: 90%
(@V_{in}= 90 V_{ac}, P_{out}= 400 W)
- Maximum ambient temperature: 50 °C
- EMI: in accordance with EN55022 Class-B
- PCB type and size: single side, 70 μm, CEM-1, 148.5x132 mm
- Low profile design: 35 mm component maximum height



Table 1. Device summary

Order code
EVL6562A-400W

Description

The board implements a 400 W, wide-range mains input, PFC pre-conditioner suitable for ATX PSU, Flat screen displays, etc. To make possible the use of a low-cost device like the L6562A at this power level, usually prohibitive for TM PFC, the chip operates with Fixed-Off-Time control. This allows continuous conduction mode operation, normally achievable with more expensive control chips and more complex control architectures. For technical details and demoboard performance, please refer to the available application note.

1 Circuit schematic

Figure 1. EVL6562A-400W schematic

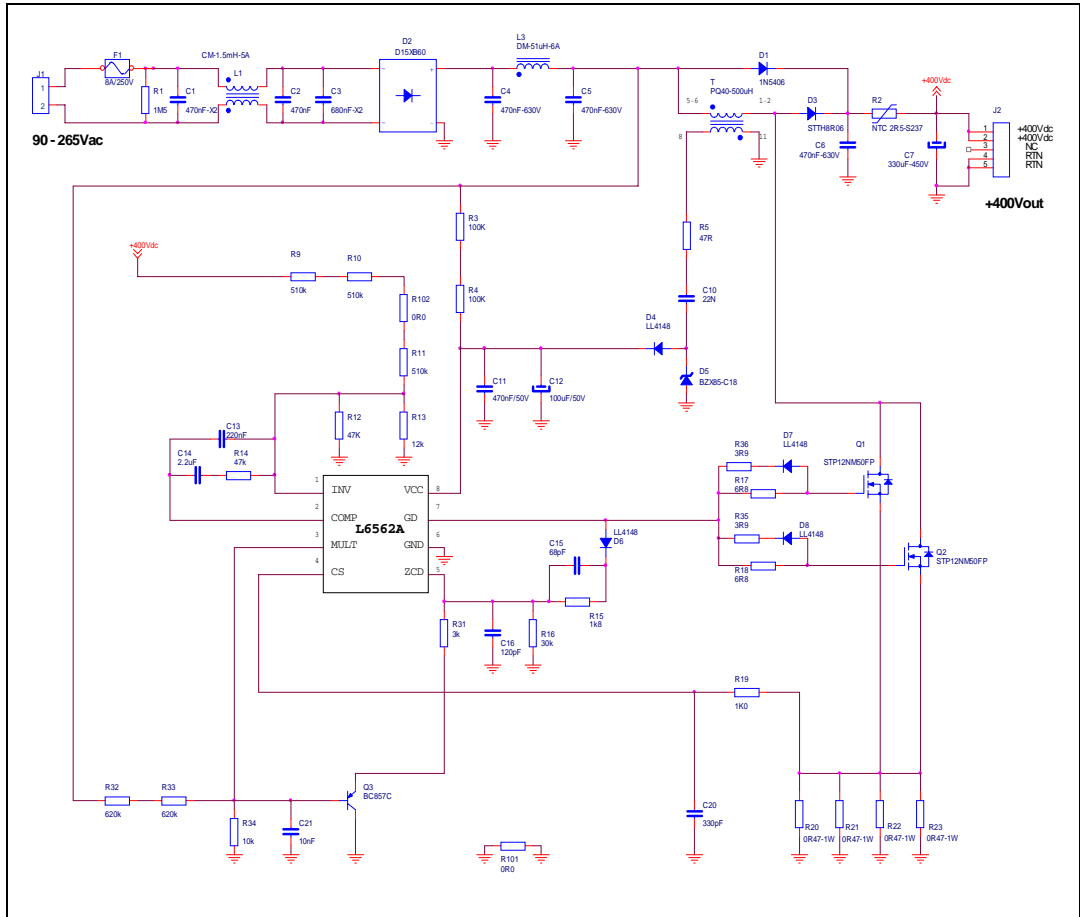

- *Boost inductor spec. (Delta Electronics 86H-5410B):*
 - vertical 6+6, PQ40+30 ferrite
 - 1 mm gap for 500 μ H primary inductance
 - Primary: 65 turns 30x0.2 mm
 - Secondary: 5 turns 0.28 mm

2 Circuit layout

Figure 2. PCB layout^(a)

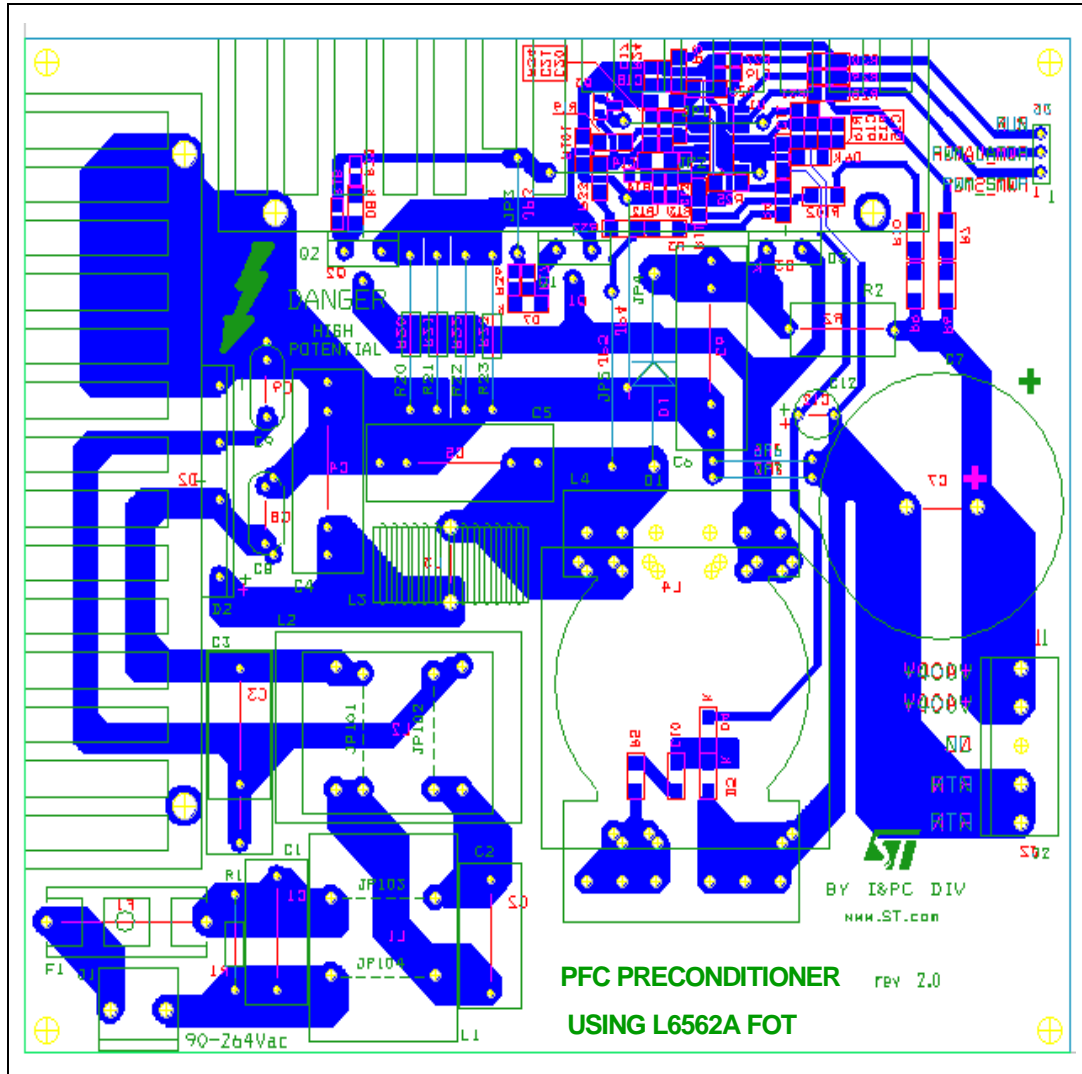

a. Not in scale

3 Typical performance

Figure 3. EVL6562A-400W compliance to EN61000-3-2 standard @full load

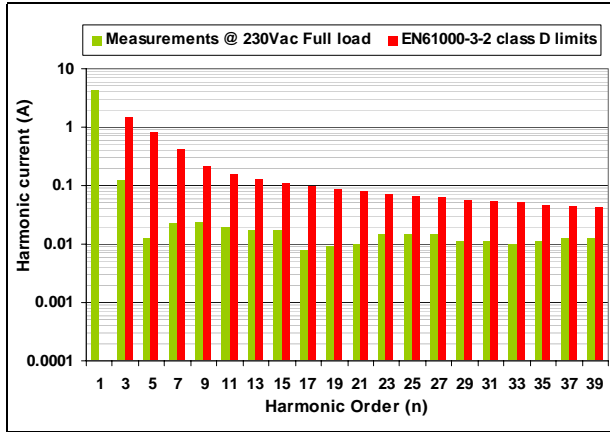

Figure 4. EVL6562A-400W compliance to JEIDA-MITI standard @full load

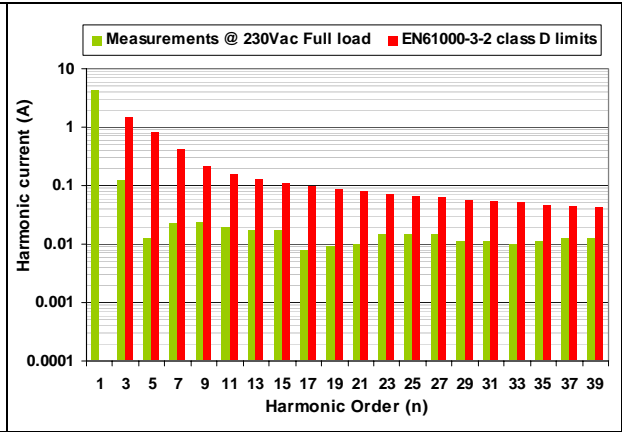

Figure 5. EVL6562A-400W compliance to EN61000-3-2 standard @70W load

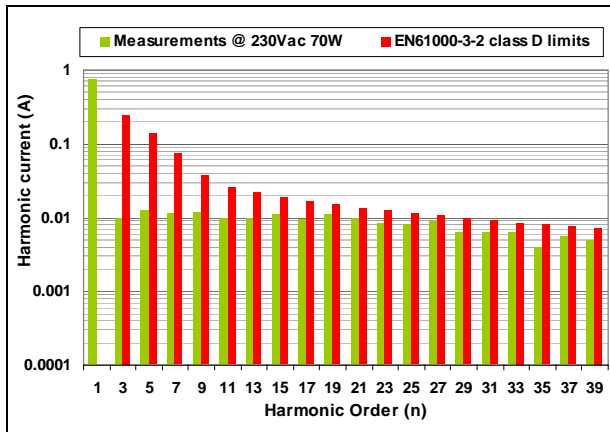

Figure 6. EVL6562A-400W compliance to JEIDA-MITI standard @70W load

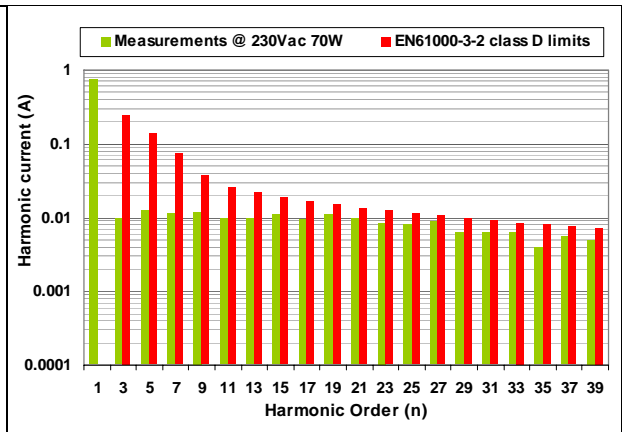

Figure 7. Power factor vs. V_{in} and load

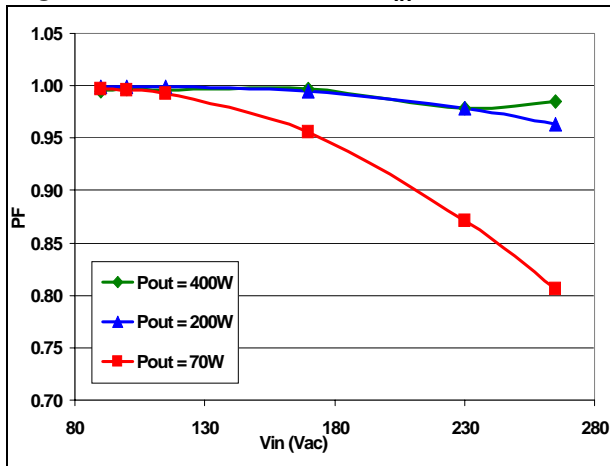
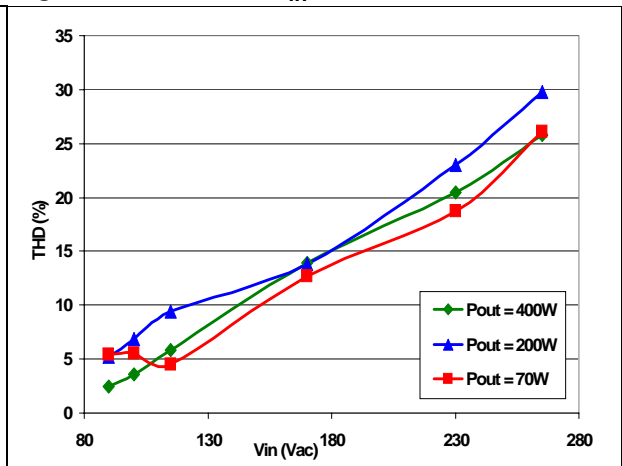

Figure 8. THD vs. V_{in} and load



Appendix A Bill of material

Table 2. Bill of material

Ref. des.	Part type part value	Case/ package	Description	Supplier
C1	470 nF- x2	DWG	X2 film capacitor R46-I 3470--M1-	ARCOTRONICS
C10	22 nF	1206	100 V SMD cericap - general purpose	AVX
C11	470 nF/50 V	1206	50 V SMD cericap - general purpose	AVX
C12	100 µF/50 V	Dia 8x11 (mm)	Aluminium elcap - yxf series - 105°C	RUBYCON
C13	220 nF	0805	50 V SMD cericap - general purpose	AVX
C14	2.2 µF	1206	50V SMD cericap - general purpose	AVX
C15	100 pF	0805	50 V SMD cericap - general purpose	AVX
C16	120 pF	0805	50 V SMD cericap - general purpose	AVX
C2	470 nF-x2	DWG	X2 film capacitor R46-I 3470--M1-	ARCOTRONICS
C20	330 pF	0805	50 V SMD cericap - general purpose	AVX
C21	10 nF	1206	50 V SMD cericap - general purpose	AVX
C3	680 nF-x2	DWG	X2 film capacitor R46-I 3680--M1-	ARCOTRONICS
C4	470 nF-630 V	DWG	film capacitor MKP - B32653A6474J	EPCOS
C5	470 nF-630 V	DWG	film capacitor MKP - B32653A6474J	EPCOS
C6	470 nF-630 V	DWG	film capacitor MKP- B32653A6474J	EPCOS
C7	330 µF-450 V	Dia 35x35 (mm)	Aluminium ELCAP - LLS series - 85°C	NICHICON
C8	Res	DWG	Not used	-
C9	Res	DWG	Not used	-
D1	1N5406	DO-201	Standard recovery rectifier	VISHAY
D2	D15XB60	DWG	Rectifier bridge	SHINDENGEN
D3	STTH8R06	TO-220FP	Ultrafast high voltage rectifier	STMICROELECTRONICS
D4	LL4148	MINIMELF	Fast switching diode	VISHAY
D5	BZX85-C18	MINIMELF	Zener diode	VISHAY
D6	LL4148	MINIMELF	Fast switching diode	VISHAY
D7	LL4148	MINIMELF	Fast switching diode	VISHAY
D8	LL4148	MINIMELF	Fast switching diode	VISHAY
F1	8 A/250 V	5 x 20 mm	8 A mains input fuse	WICKMANN
J1			3-pins conn. (central rem.) P 3.96 KK series	MOLEX
J2			5-pins conn. (central rem.) P 3.96 KK series	MOLEX
JP101	Jumper		Wire jumper	

Table 2. Bill of material (continued)

Ref. des.	Part type part value	Case/ package	Description	Supplier
JP102	Jumper		Wire jumper	
L1	CM-1.5 mH-5 A	DWG	CM CHOKE - LFR2205B	DELTA ELECTRONICS
L2	Res	DWG	Not used	-
L3	DM-51 μ H-6A	DWG	FILTER INDUCTOR - LSR2306-1	DELTA ELECTRONICS
L4	PQ40-500 μ H	DWG	PFC inductor - 86 H-5410B	DELTA ELECTRONICS
Q1	STP12NM50FP	TO-220FP	N-channel Power MOSFET	STMICROELECTRONICS
Q2	STP12NM50FP	TO-220FP	N-channel Power MOSFET	STMICROELECTRONICS
Q3	BC857C	SOT-23	Small signal BJT - PNP	VISHAY
R1	1M5	AXIAL	HV resistor	BC COMPONENTS
R10	510 k Ω	1206	SMD std film res - 1% - 250ppm/ $^{\circ}$ C	BC COMPONENTS
R11	510 k Ω	1206	SMD std film res - 1% - 250ppm/ $^{\circ}$ C	BC COMPONENTS
R12	47 k Ω	0805	SMD std film res - 1% - 250ppm/ $^{\circ}$ C	BC COMPONENTS
R13	12 k Ω	0805	SMD std film res - 1% - 250ppm/ $^{\circ}$ C	BC COMPONENTS
R14	47 k Ω	0805	SMD std film res - 5% - 250ppm/ $^{\circ}$ C	BC COMPONENTS
R15	1 k8 Ω	0805	SMD std film res - 1% - 100ppm/ $^{\circ}$ C	BC COMPONENTS
R16	30 k Ω	0805	SMD std film res - 1% - 100ppm/ $^{\circ}$ C	BC COMPONENTS
R17	6R8	0805	SMD std film res - 5% - 250ppm/ $^{\circ}$ C	BC COMPONENTS
R18	6R8	0805	SMD std film res - 5% - 250ppm/ $^{\circ}$ C	BC COMPONENTS
R19	1 K Ω	1206	SMD std film res - 5% - 250ppm/ $^{\circ}$ C	BC COMPONENTS
R2	NTC 2R5	DWG	NTC resistor 2R5 S237	EPCOS
R20	0R47-1 W	AXIAL	AXIAL res - 5% - 250ppm/ $^{\circ}$ C	BC COMPONENTS
R21	0R47-1 W	AXIAL	AXIAL res - 5% - 250ppm/ $^{\circ}$ C	BC COMPONENTS
R22	0R47-1 W	AXIAL	AXIAL res - 5% - 250ppm/ $^{\circ}$ C	BC COMPONENTS
R23	0R47-1 W	AXIAL	AXIAL res - 5% - 250ppm/ $^{\circ}$ C	BC COMPONENTS
R25	Res	1206	Not used	-
R3	100 K Ω	1206	SMD std film res - 5% - 250ppm/ $^{\circ}$ C	BC COMPONENTS
R31	3 k Ω	0805	SMD std film res - 1% - 100ppm/ $^{\circ}$ C	BC COMPONENTS
R32	620 k Ω	1206	SMD std film res - 5% - 250ppm/ $^{\circ}$ C	BC COMPONENTS
R33	620 k Ω	1206	SMD std film res - 5% - 250ppm/ $^{\circ}$ C	BC COMPONENTS
R34	10 k Ω	1206	SMD std film res - 5% - 250ppm/ $^{\circ}$ C	BC COMPONENTS
R35	3R9	0805	SMD std film res - 5% - 250ppm/ $^{\circ}$ C	BC COMPONENTS
R36	3R9	0805	SMD std film res - 5% - 250ppm/ $^{\circ}$ C	BC COMPONENTS
R4	100 K Ω	1206	SMD std film res - 5% - 250ppm/ $^{\circ}$ C	BC COMPONENTS
R5	47R	1206	SMD std film res - 5% - 250ppm/ $^{\circ}$ C	BC COMPONENTS

Table 2. Bill of material (continued)

Ref. des.	Part type part value	Case/ package	Description	Supplier
R9	510 k Ω	1206	SMD std film res - 1% - 250ppm/ $^{\circ}$ C	BC COMPONENTS
R101	0R0	1206	SMD std film res - 5% - 250ppm/ $^{\circ}$ C	BC COMPONENTS
R102	0R0	1206	SMD std film res - 5% - 250ppm/ $^{\circ}$ C	BC COMPONENTS
U1	L6562A	SO-8	Transition-mode PFC controller	STMICROELECTRONICS

4 Revision history

Table 3. Document revision history

Date	Revision	Changes
07-Feb-2008	1	Initial release.

Please Read Carefully:

Information in this document is provided solely in connection with ST products. STMicroelectronics NV and its subsidiaries ("ST") reserve the right to make changes, corrections, modifications or improvements, to this document, and the products and services described herein at any time, without notice.

All ST products are sold pursuant to ST's terms and conditions of sale.

Purchasers are solely responsible for the choice, selection and use of the ST products and services described herein, and ST assumes no liability whatsoever relating to the choice, selection or use of the ST products and services described herein.

No license, express or implied, by estoppel or otherwise, to any intellectual property rights is granted under this document. If any part of this document refers to any third party products or services it shall not be deemed a license grant by ST for the use of such third party products or services, or any intellectual property contained therein or considered as a warranty covering the use in any manner whatsoever of such third party products or services or any intellectual property contained therein.

UNLESS OTHERWISE SET FORTH IN ST'S TERMS AND CONDITIONS OF SALE ST DISCLAIMS ANY EXPRESS OR IMPLIED WARRANTY WITH RESPECT TO THE USE AND/OR SALE OF ST PRODUCTS INCLUDING WITHOUT LIMITATION IMPLIED WARRANTIES OF MERCHANTABILITY, FITNESS FOR A PARTICULAR PURPOSE (AND THEIR EQUIVALENTS UNDER THE LAWS OF ANY JURISDICTION), OR INFRINGEMENT OF ANY PATENT, COPYRIGHT OR OTHER INTELLECTUAL PROPERTY RIGHT.

UNLESS EXPRESSLY APPROVED IN WRITING BY AN AUTHORIZED ST REPRESENTATIVE, ST PRODUCTS ARE NOT RECOMMENDED, AUTHORIZED OR WARRANTED FOR USE IN MILITARY, AIR CRAFT, SPACE, LIFE SAVING, OR LIFE SUSTAINING APPLICATIONS, NOR IN PRODUCTS OR SYSTEMS WHERE FAILURE OR MALFUNCTION MAY RESULT IN PERSONAL INJURY, DEATH, OR SEVERE PROPERTY OR ENVIRONMENTAL DAMAGE. ST PRODUCTS WHICH ARE NOT SPECIFIED AS "AUTOMOTIVE GRADE" MAY ONLY BE USED IN AUTOMOTIVE APPLICATIONS AT USER'S OWN RISK.

Resale of ST products with provisions different from the statements and/or technical features set forth in this document shall immediately void any warranty granted by ST for the ST product or service described herein and shall not create or extend in any manner whatsoever, any liability of ST.

ST and the ST logo are trademarks or registered trademarks of ST in various countries.

Information in this document supersedes and replaces all information previously supplied.

The ST logo is a registered trademark of STMicroelectronics. All other names are the property of their respective owners.

© 2008 STMicroelectronics - All rights reserved

STMicroelectronics group of companies

Australia - Belgium - Brazil - Canada - China - Czech Republic - Finland - France - Germany - Hong Kong - India - Israel - Italy - Japan - Malaysia - Malta - Morocco - Singapore - Spain - Sweden - Switzerland - United Kingdom - United States of America

www.st.com