

MITSUBISHI IGBT MODULES
CM75TL-24NF

HIGH POWER SWITCHING USE

CM75TL-24NF



- IC 75A
- VCES 1200V
- Insulated Type
- 6-elements in a pack

APPLICATION

AC drive inverters & Servo controls, etc

OUTLINE DRAWING & CIRCUIT DIAGRAM

Dimensions in mm

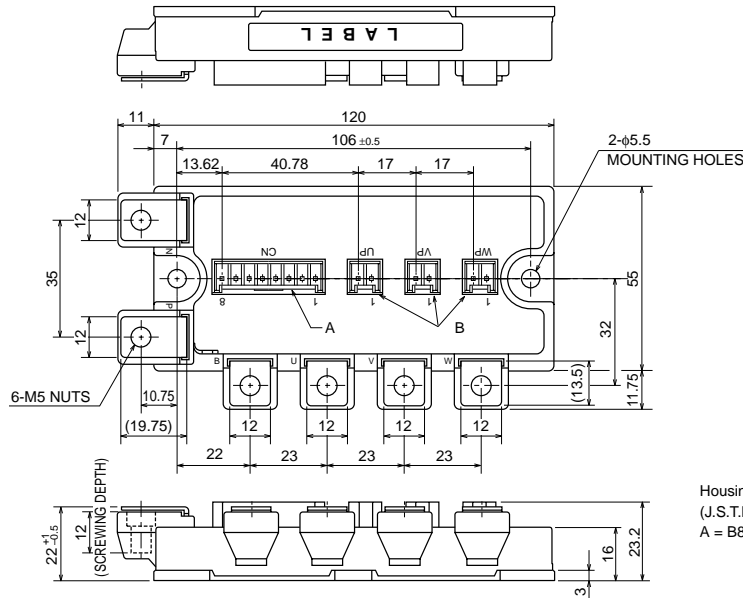

Housing Type of A and B
 (J.S.T.Mfg.Co.Ltd)
 A = B8P-VH-FB-B, B = B2P-VH-FB-B

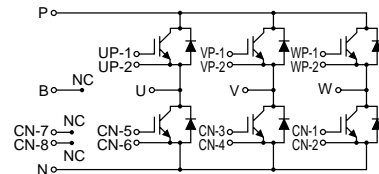

CIRCUIT DIAGRAM

CM75TL-24NF

HIGH POWER SWITCHING USE

ABSOLUTE MAXIMUM RATINGS ($T_j = 25^\circ\text{C}$)

Symbol	Parameter	Conditions	Ratings	Unit
VCES	Collector-emitter voltage	G-E Short	1200	V
VGES	Gate-emitter voltage	C-E Short	± 20	V
IC	Collector current	DC, $T_c = 87^\circ\text{C}^{*1}$	75	A
ICM		Pulse (Note 2)	150	A
IE (Note 1)	Emitter current		75	A
IEM (Note 1)		Pulse (Note 2)	150	A
PC (Note 3)	Maximum collector dissipation	$T_c = 25^\circ\text{C}$	520	W
Tj	Junction temperature		$-40 \sim +150$	$^\circ\text{C}$
Tstg	Storage temperature		$-40 \sim +125$	$^\circ\text{C}$
Viso	Isolation voltage	Main Terminal to base plate, AC 1 min.	2500	V
—	Torque strength	Main Terminal M5	2.5 ~ 3.5	N • m
—		Mounting holes M5	2.5 ~ 3.5	N • m
—	Weight	Typical value	350	g

ELECTRICAL CHARACTERISTICS ($T_j = 25^\circ\text{C}$)

Symbol	Parameter	Test conditions	Limits			Unit
			Min.	Typ.	Max.	
ICES	Collector cutoff current	$V_{CE} = V_{CES}, V_{GE} = 0V$	—	—	1	mA
VGE(th)	Gate-emitter threshold voltage	$I_C = 7.5\text{mA}, V_{CE} = 10V$	6	7	8	V
IGES	Gate leakage current	$V_{GE} = V_{GES}, V_{CE} = 0V$	—	—	0.5	μA
VCE(sat)	Collector-emitter saturation voltage	$I_C = 75A, V_{GE} = 15V$ $T_j = 25^\circ\text{C}$ $T_j = 125^\circ\text{C}$	—	2.1 2.4	3.0 —	V
Cies	Input capacitance	$V_{CE} = 10V$ $V_{GE} = 0V$	—	—	11.5	nF
Coes	Output capacitance		—	—	1.0	nF
Cres	Reverse transfer capacitance		—	—	0.23	nF
QG	Total gate charge	$V_{CC} = 600V, I_C = 75A, V_{GE} = 15V$	—	338	—	nC
td(on)	Turn-on delay time	$V_{CC} = 600V, I_C = 75A$ $V_{GE1} = V_{GE2} = 15V$ $R_G = 4.2\Omega$, Inductive load switching operation $I_E = 75A$	—	—	100	ns
tr	Turn-on rise time		—	—	50	ns
td(off)	Turn-off delay time		—	—	300	ns
tf	Turn-off fall time		—	—	350	ns
trr (Note 1)	Reverse recovery time		—	—	120	ns
Qrr (Note 1)	Reverse recovery charge		—	3	—	μC
VEC(Note 1)	Emitter-collector voltage	$I_E = 75A, V_{GE} = 0V$	—	—	3.8	V
Rth(j-c)Q	Thermal resistance	IGBT part (1/6 module) ^{*1}	—	—	0.24	$^\circ\text{C}/\text{W}$
Rth(j-c)R		FWDi part (1/6 module) ^{*1}	—	—	0.36	$^\circ\text{C}/\text{W}$
Rth(c-f)	Contact thermal resistance	Case to fin, Thermal compound Applied (1/6 module) ^{*2}	—	0.085	—	$^\circ\text{C}/\text{W}$
RG	External gate resistance		4.2	—	63	Ω

*1 : T_c measured point is just under the chips.If you use this value, $R_{th}(f-a)$ should be measured just under the chips.

*2 : Typical value is measured by using Shin-etsu Silicone "G-746".

Note 1. IE, VEC, trr & Qrr represent characteristics of the anti-parallel, emitter to collector free-wheel diode (FWDi).

2. Pulse width and repetition rate should be such that the device junction temp. (T_j) does not exceed T_{jmax} rating.3. Junction temperature (T_j) should not increase beyond 150°C .

4. Pulse width and repetition rate should be such as to cause negligible temperature rise.

CM75TL-24NF

HIGH POWER SWITCHING USE

PERFORMANCE CURVES

OUTPUT CHARACTERISTICS (TYPICAL)

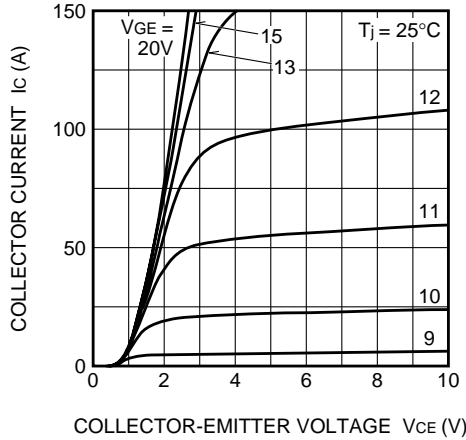

COLLECTOR-EMITTER SATURATION VOLTAGE CHARACTERISTICS (TYPICAL)

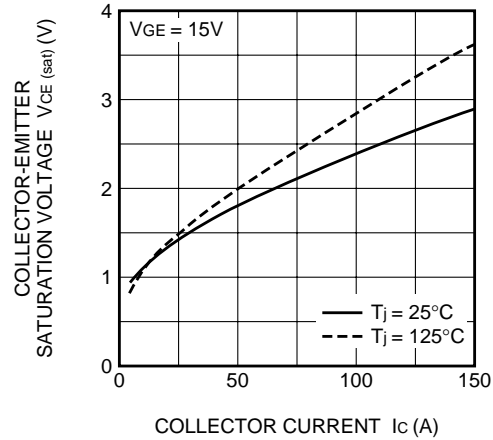

COLLECTOR-EMITTER SATURATION VOLTAGE CHARACTERISTICS (TYPICAL)

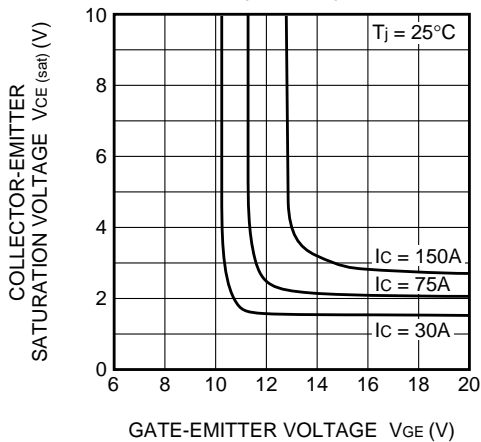

FREE-WHEEL DIODE FORWARD CHARACTERISTICS (TYPICAL)

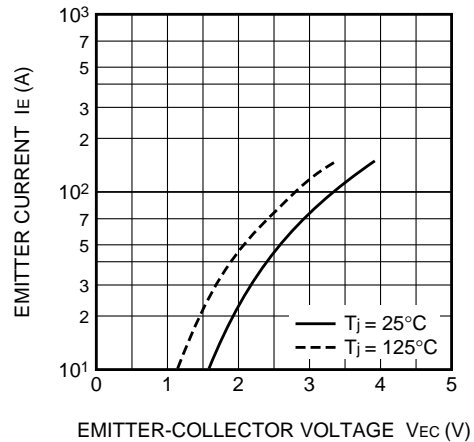

CAPACITANCE-VCE CHARACTERISTICS (TYPICAL)

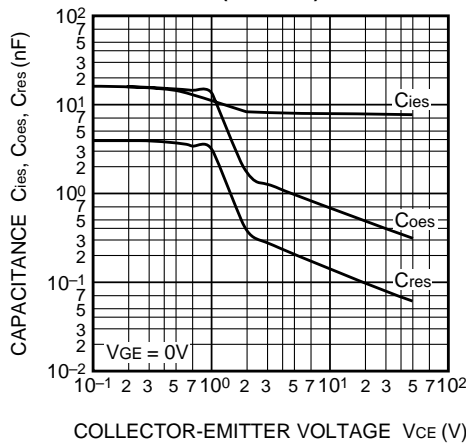

HALF-BRIDGE SWITCHING CHARACTERISTICS (TYPICAL)

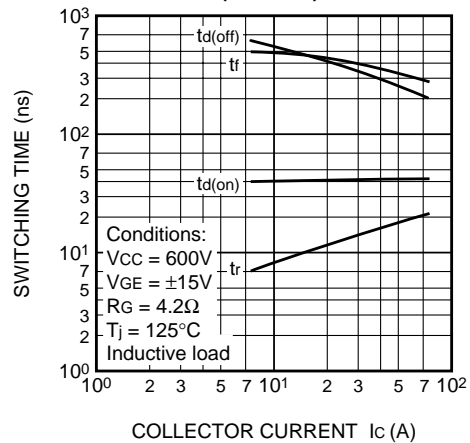

REVERSE RECOVERY CHARACTERISTICS OF FREE-WHEEL DIODE (TYPICAL)

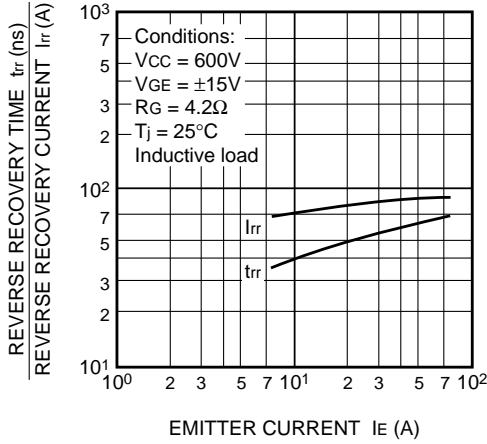

TRANSIENT THERMAL IMPEDANCE CHARACTERISTICS (IGBT part & FWDi part)

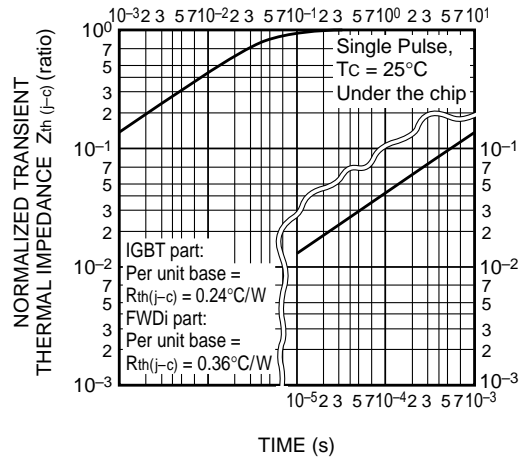

SWITCHING LOSS vs. COLLECTOR CURRENT (TYPICAL)

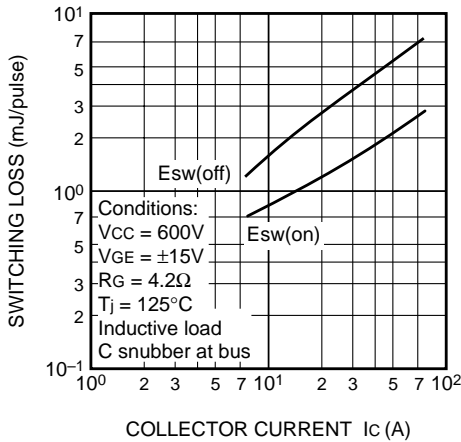

SWITCHING LOSS vs. GATE RESISTANCE (TYPICAL)

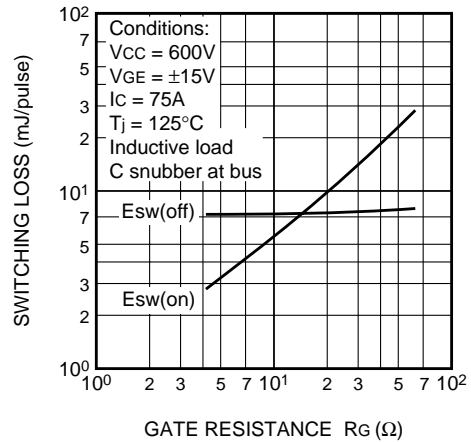

RECOVERY LOSS vs. IE (TYPICAL)

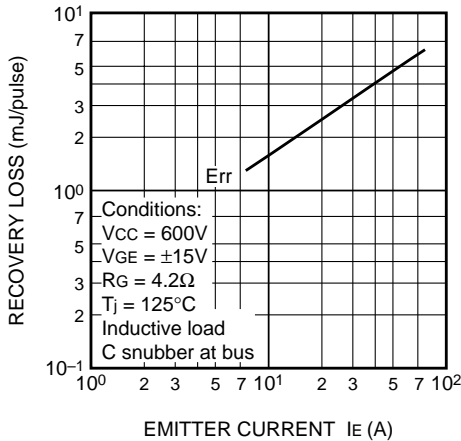

RECOVERY LOSS vs. GATE RESISTANCE (TYPICAL)

