

isc Silicon NPN RF Transistor

BFS520

DESCRIPTION

- Low Noise Figure
 $NF = 1.1 \text{ dB TYP. @ } V_{CE} = 6 \text{ V, } I_C = 5 \text{ mA, } f = 900 \text{ MHz}$
- High Current-Gain—Bandwidth Product
 $f_T = 9 \text{ GHz TYP. @ } V_{CE} = 6 \text{ V, } I_C = 20 \text{ mA, } f = 1 \text{ GHz}$

APPLICATIONS

- Designed for wideband applications such as satellite TV tuners, cellular phones, cordless phones, pagers etc, with signal frequencies up to 2 GHz.

ABSOLUTE MAXIMUM RATINGS($T_a=25^\circ\text{C}$)

| SYMBOL | PARAMETER | VALUE | UNIT |
|-----------|---|---------|------------------|
| V_{CBO} | Collector-Base Voltage | 20 | V |
| V_{CES} | Collector-Emitter Voltage $R_{BE} = 0$ | 15 | V |
| V_{EBO} | Emitter-Base Voltage | 2.5 | V |
| I_C | Collector Current-Continuous | 70 | mA |
| P_C | Collector Power Dissipation @ $T_C=25^\circ\text{C}$ | 0.3 | W |
| T_J | Junction Temperature | 175 | $^\circ\text{C}$ |
| T_{stg} | Storage Temperature Range | -65~150 | $^\circ\text{C}$ |

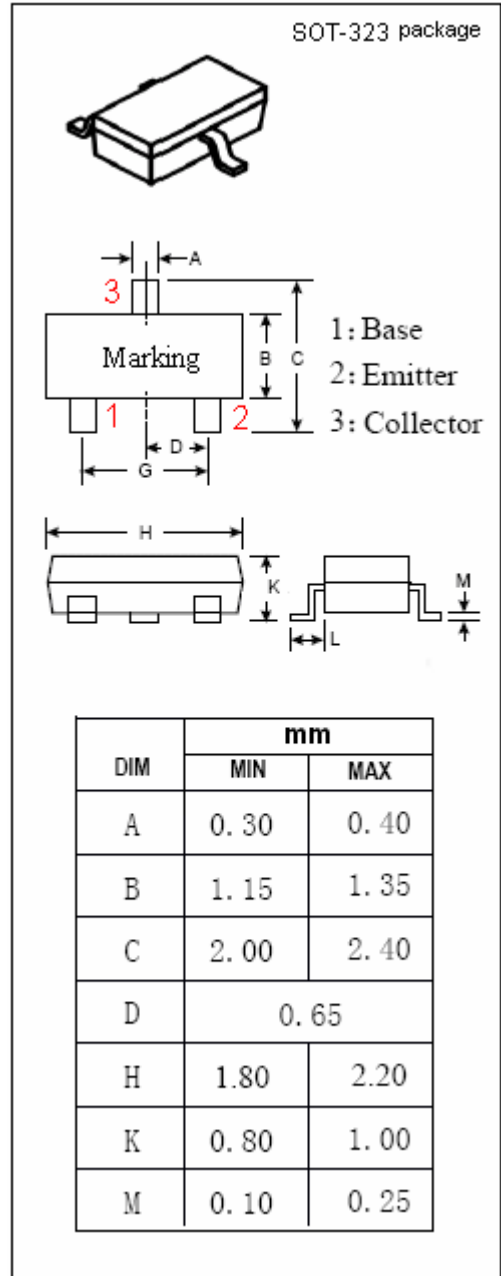

isc Silicon NPN RF Transistor

BFS520

ELECTRICAL CHARACTERISTICS

T_C=25°C unless otherwise specified

| SYMBOL | PARAMETER | CONDITIONS | MIN | TYP. | MAX | UNIT |
|---------------------------------|--------------------------------|---|-----|------|------|------|
| I _{CBO} | Collector Cutoff Current | V _{CB} = 6V; I _E = 0 | | | 0.05 | μ A |
| h _{FE} | DC Current Gain | I _C = 20mA ; V _{CE} = 6V | 60 | | 250 | |
| f _T | Current-Gain—Bandwidth Product | I _C = 20mA ; V _{CE} = 6V; f= 1GHz | | 9 | | GHz |
| C _{OB} | Output Capacitance | I _E = 0 ; V _{CB} = 6V; f= 1MHz | | 0.5 | | pF |
| C _{re} | Feedback Capacitance | I _C = 0 ; V _{CB} = 6V; f= 1MHz | | 0.4 | | pF |
| S _{21e} ² | Insertion Power Gain | I _C = 20mA ; V _{CE} = 6V; f= 900MHz | 13 | 14 | | dB |
| NF | Noise Figure | I _C = 5mA ; V _{CE} = 6V; f= 900MHz | | 1.1 | 1.6 | dB |
| NF | Noise Figure | I _C = 20mA ; V _{CE} = 6V; f= 900MHz | | 1.6 | 2.1 | dB |
| NF | Noise Figure | I _C = 5mA ; V _{CE} = 6V; f= 2GHz | | 1.9 | | dB |

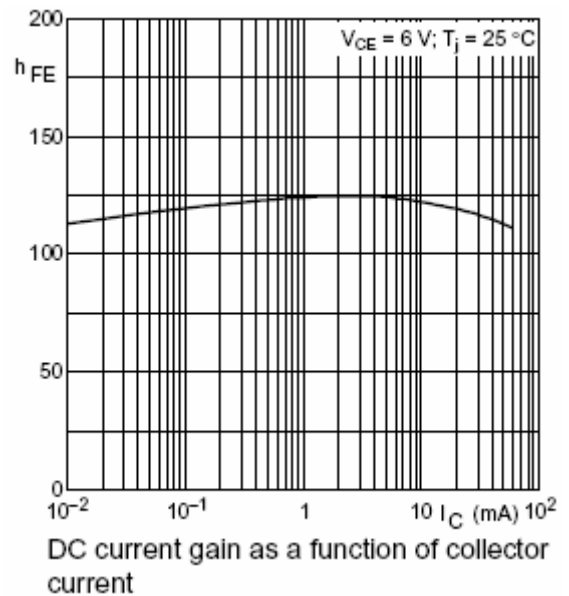
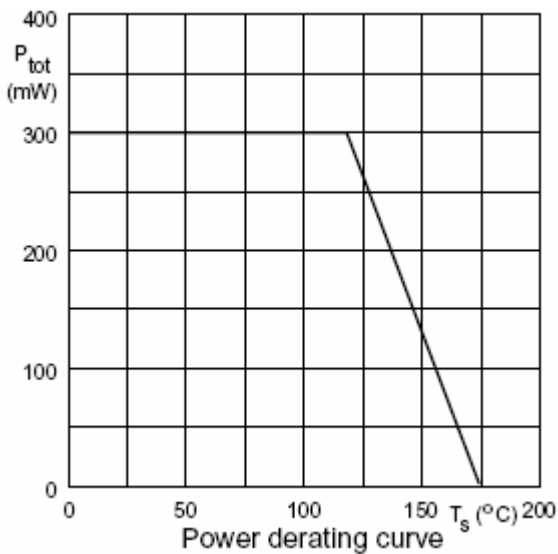

isc Silicon NPN RF Transistor

BFS520

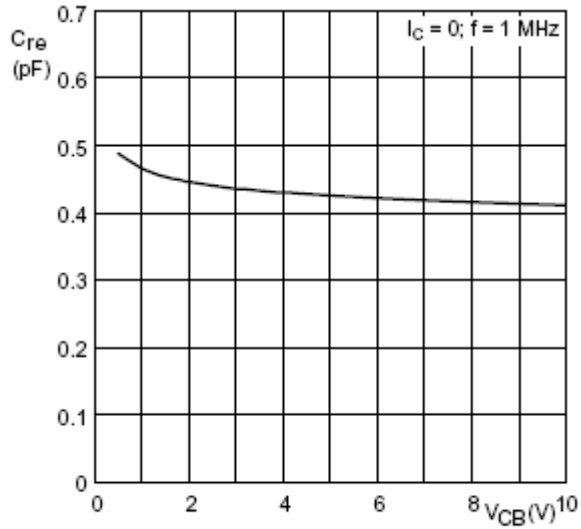

Feedback capacitance as a function of collector-base voltage

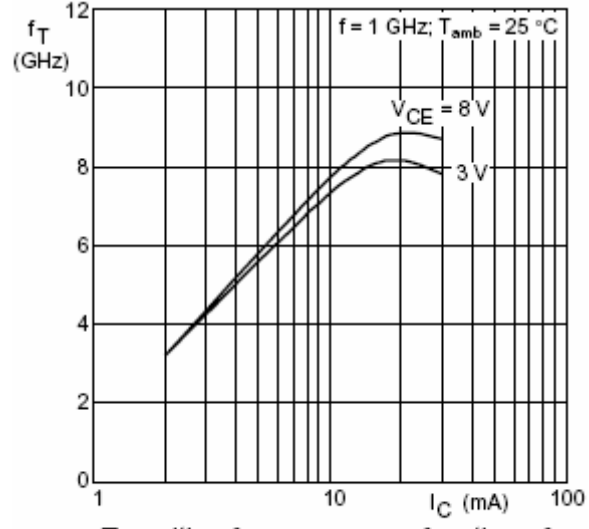

Transition frequency as a function of collector current

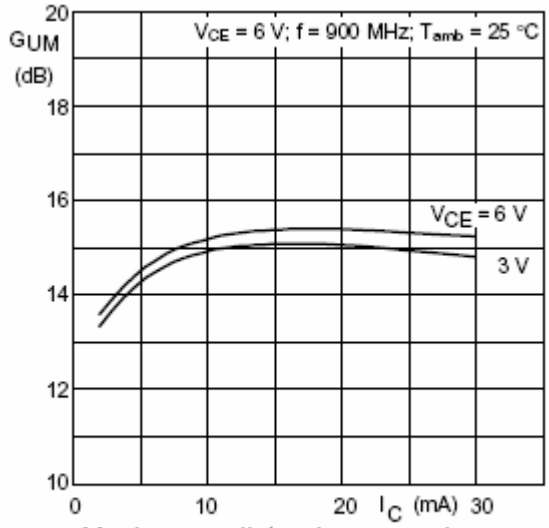

Maximum unilateral power gain as a function of collector current

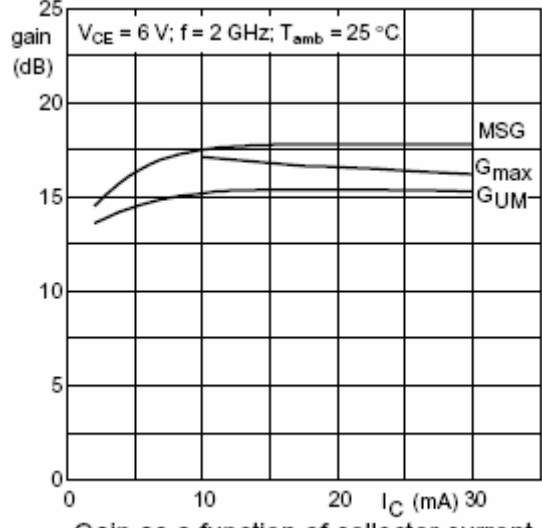

Gain as a function of collector current

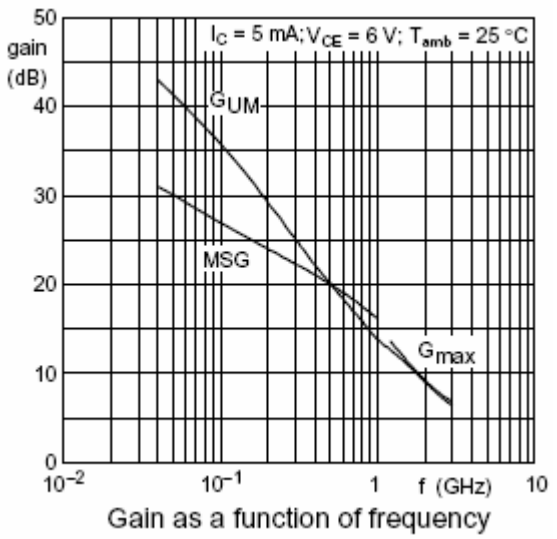

Gain as a function of frequency

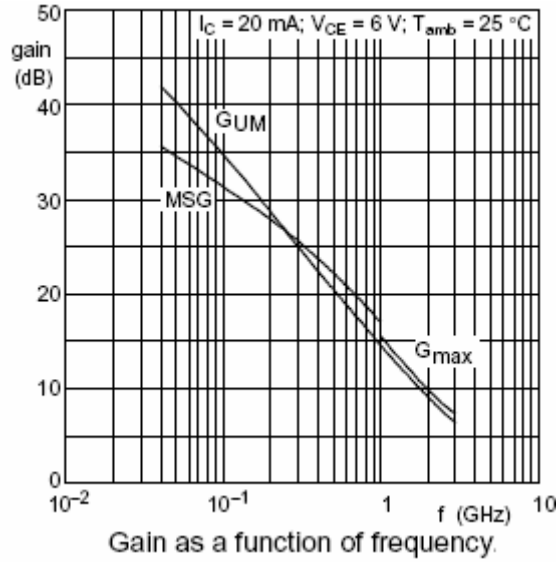

Gain as a function of frequency

isc Silicon NPN RF Transistor

BFS520

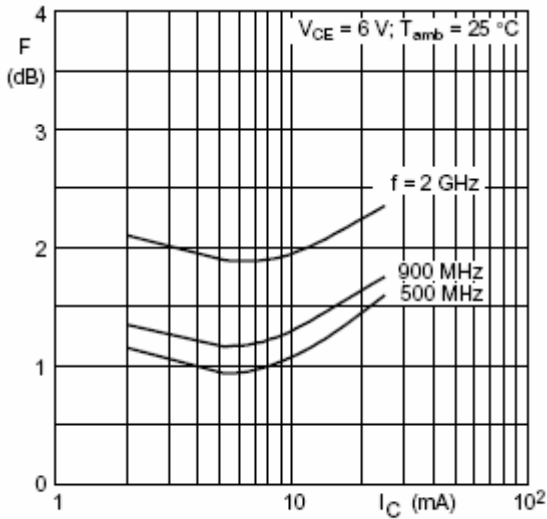

Minimum noise figure as a function of collector current

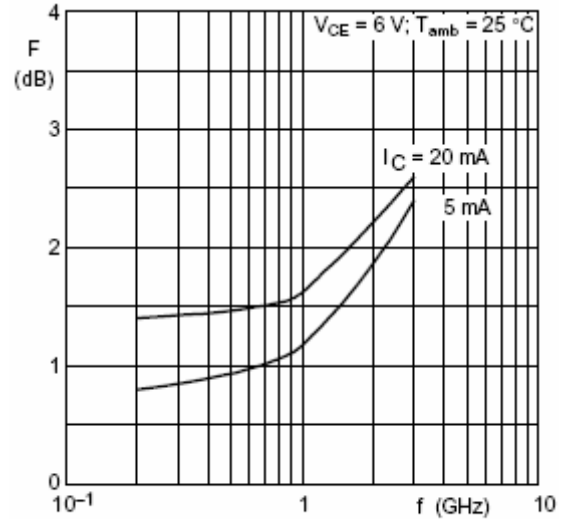

Minimum noise figure as a function of frequency

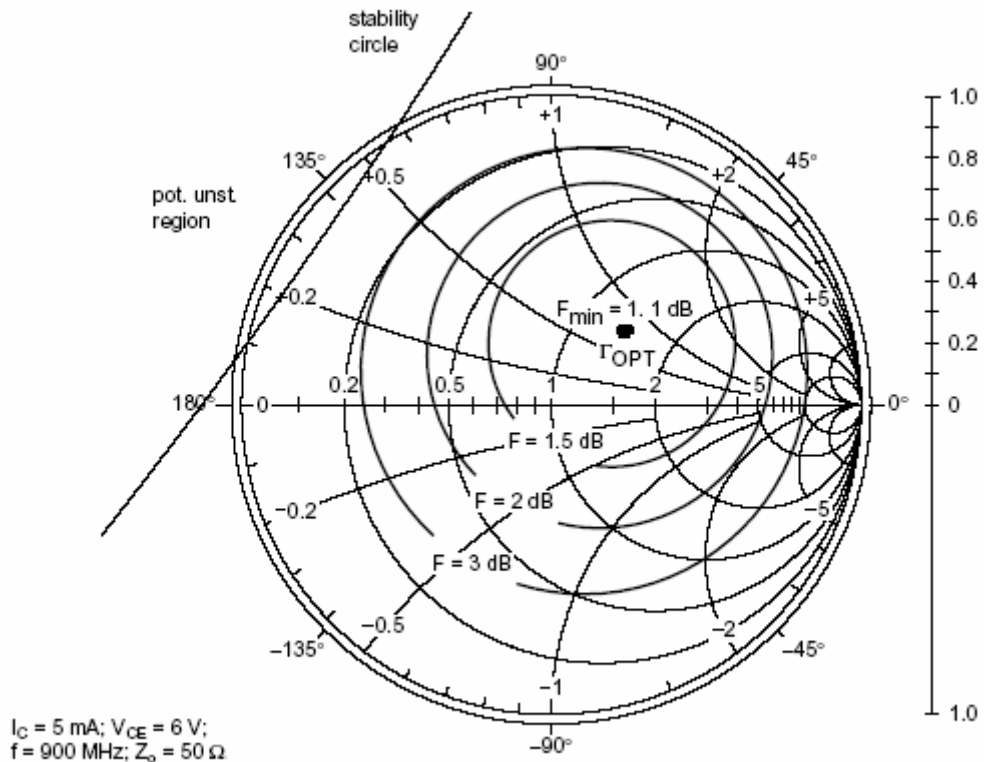

Noise circle

isc Silicon NPN RF Transistor

BFS520

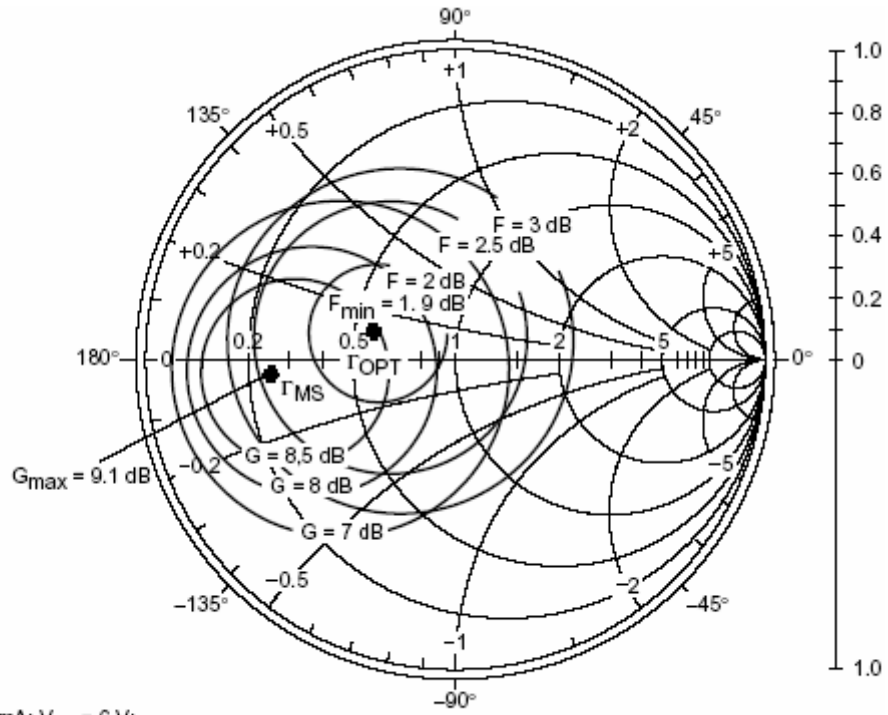

$I_C = 5 \text{ mA}; V_{CE} = 6 \text{ V};$
 $f = 2 \text{ GHz}; Z_0 = 50 \Omega.$

Noise circle

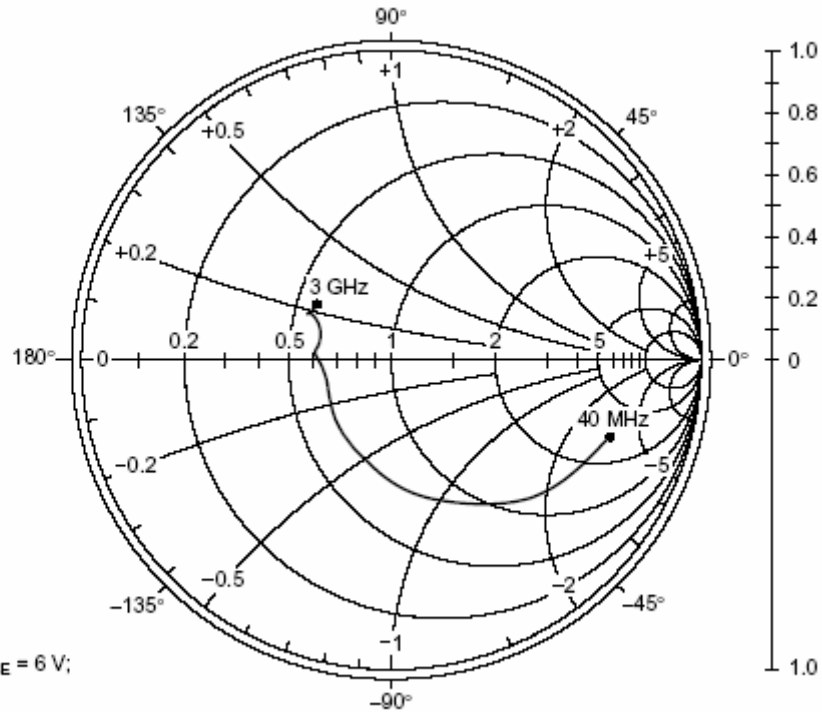

$I_C = 20 \text{ mA}; V_{CE} = 6 \text{ V};$
 $Z_0 = 50 \Omega.$

Common emitter input reflection coefficient (S_{11})

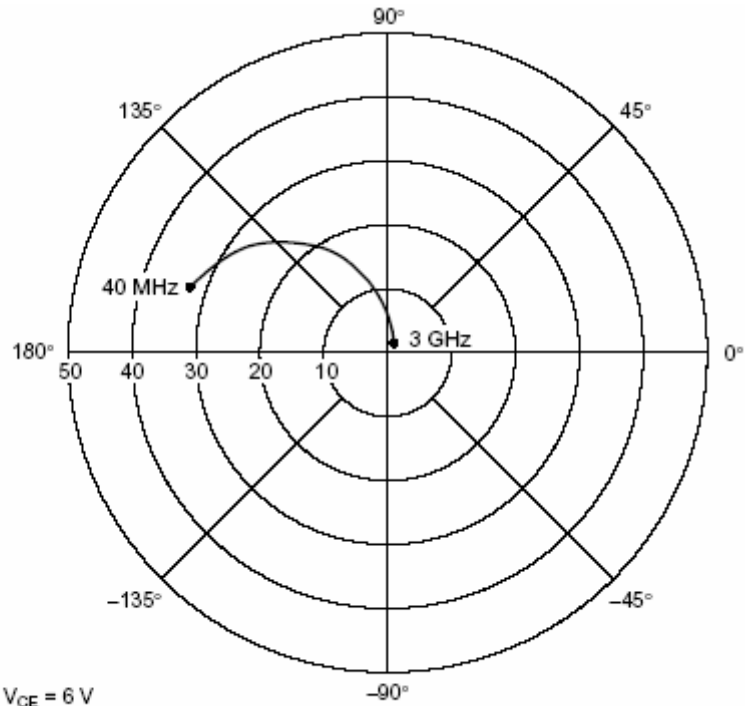

Common emitter forward transmission coefficient (S_{21})

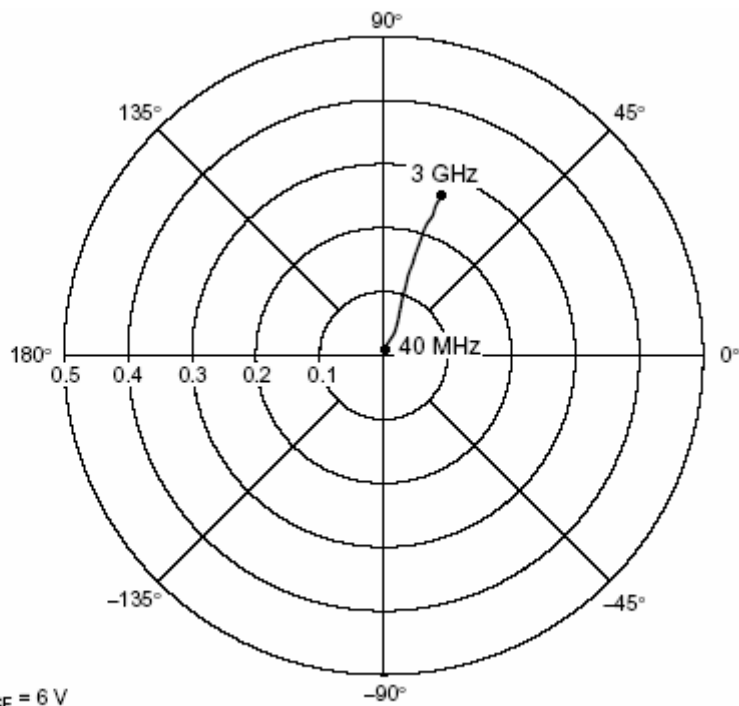

Common emitter reverse transmission coefficient (S_{12})

isc Silicon NPN RF Transistor

BFS520

