

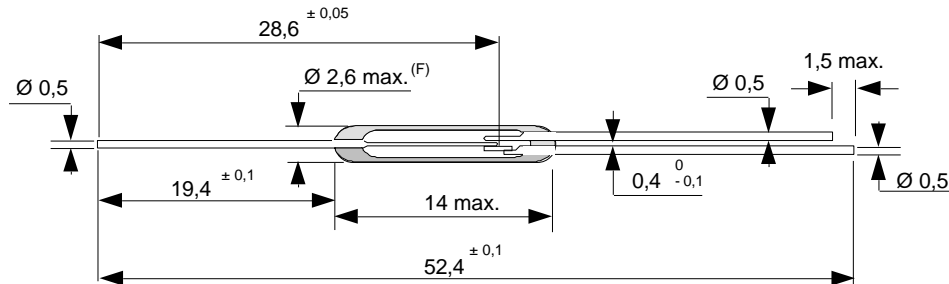

INTERRUPTEUR REED REED SWITCH

INVERSEUR CONTACT SEC DRY CONTACT CHANGEOVER

CG21



Dossier / File
E69913

CARACTERISTIQUES ELECTRIQUES / ELECTRICAL DATA

Puissance maxi commutable / Max. switching power	contact repos / normally closed	3 W
	contact travail / normally open	8 W
Tension maxi commutable / Max. switching voltage		100 Vdc
Courant maxi commutable / Max. switching current		250 mA
Courant de travail / Carrying current		0,5 A
Tension typique de tenue / Typical dielectric strength		200 Vdc
Résistance de contact initiale (max) / Initial contact resistance		< 100 mΩ
Méthode de mesure / Test process		

Bobine / Coil : L4989

Mesure en 4 points / 4 points measurement

Rampe / Slope $\approx 100 \text{ At / s}$

$I = 1 \text{ mA} ; U = 10 \text{ V}$

En + et en - ($\approx 1 \text{ KHz}$)

Alimentation de bobine / Coil voltage: ATF + 20 ATF

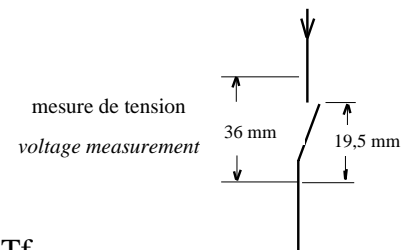
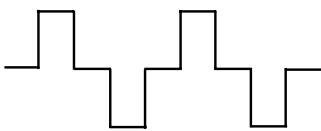

Résistance d'isolement (min) / Insulation resistance	10⁹ Ω
Capacité / Capacitance	2,5 pF
Fréquence maxi d'utilisation / Max. frequency	150 Hz
Fréquence de résonance / Resonant frequency	3 KHz
Temps de commutation maximum	

Méthode de mesure / Test process ---> Alimentation de bobine / Coil voltage: ATF + 30%

à l'action / max. operate time

contact travail / normally open 1,5 ms

au relâchement / max. release time

contact repos / normally closed 2 ms

Proud to serve you

celduc®
r e l a i s

CARACTERISTIQUES PHYSIQUES / PHYSICAL DATA

Matériau utilisé pour le contact / Contact material	Rhodium
Température maxi d'utilisation / Max. operating temperature	- 40 à +125°C
Température de stockage / Storage temperature	- 55 à +125°C
Chocs (1/2 onde - 11 ms) / Shocks (1/2 sine wave - 11 ms)	20 g
Vibrations (de 30 à 2000 Hz) / Vibrations	30 g
Brasabilité / Solderability	suivant / according to CEI 68-2-20

CARACTERISTIQUES MAGNETIQUES / MAGNETICAL DATA

Bobine de test / Test coil : Ø ext. = 13,5 mm ; Ø int. = 5 mm ; Long. = 18,6 mm
 Fil utilisé / Electric wire: Ø = 0,08 mm ;
 Nombre de spires / turns : 5 000

Référence (Plage standard d'Ampères Tours de fermeture) / Reference (standard pull-in value)

CG211535 (de 15 à 35 ATf / from 15 up to 35 AT)

Pour des applications particulières (autres sensibilités, plage réduite, coupe, cambrage), prière de nous consulter.
 For special applications (others pull-in-range, reduced range, cutting out, bending), please contact us.

Dwell **0 à 2 ATf**

Différentielle : $\frac{ATO(NF / NC)}{ATF (NO / NO)} / \frac{Pull\ in\ value}{Drop\ out\ value}$ **0,5 ≤ D ≤ 0,65**

Durée de vie / Electrical expectancy

Taux de défaillance / cumulative failure rate (%)

U = 24 V

I = 120 mA

Charge résistive / Resistive load

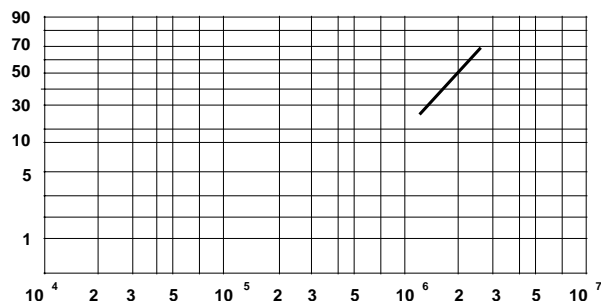

Nombre d'opérations / number of operations



ISO 9001
N° 1993/1106a

celduc[®]
r e l a i s

www.celduc.com

Rue Ampère B.P. 4 42290 SORBIERS - FRANCE E-Mail : celduc-relais@celduc.com
 Fax +33 (0) 4 77 53 85 51 Service Commercial France Tél. : +33 (0) 4 77 53 90 20
 Sales Dept. For Europe Tel. : +33 (0) 4 77 53 90 21 Sales Dept. Asia : Tél. +33 (0) 4 77 53 90 19

CAMBRAGES SPECIAUX /Special bending

CG21V1 ..

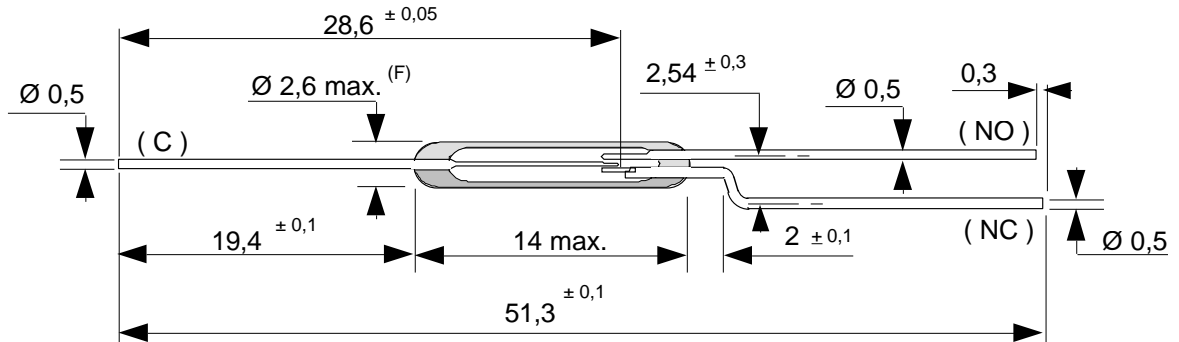

CG21V4 ..

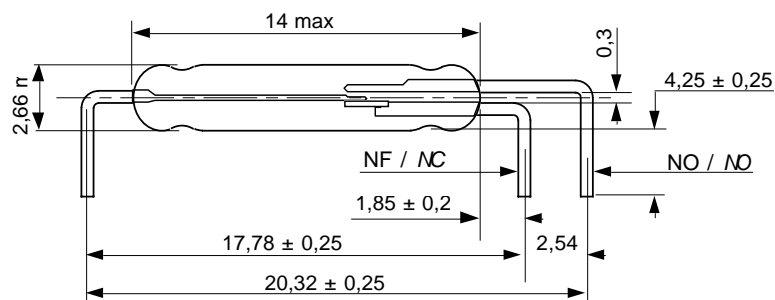

CG21P025 : 17-22ATF

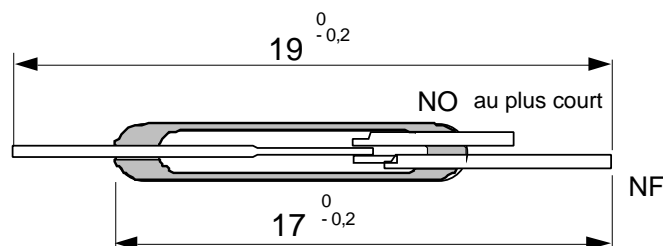

ISO 9001
N° 1993/1106a

celduc[®]
r e l a i s

www.celduc.com

Rue Ampère B.P. 4 42290 SORBIERS - FRANCE E-Mail : celduc-relais@celduc.com
Fax +33 (0) 4 77 53 85 51 Service Commercial France Tél. : +33 (0) 4 77 53 90 20
Sales Dept.For Europe Tel. : +33 (0) 4 77 53 90 21 Sales Dept. Asia : Tél. +33 (0) 4 77 53 90 19

CAMBRAGES SPECIAUX /*Special bending*

CG21P023 : 15-30ATF

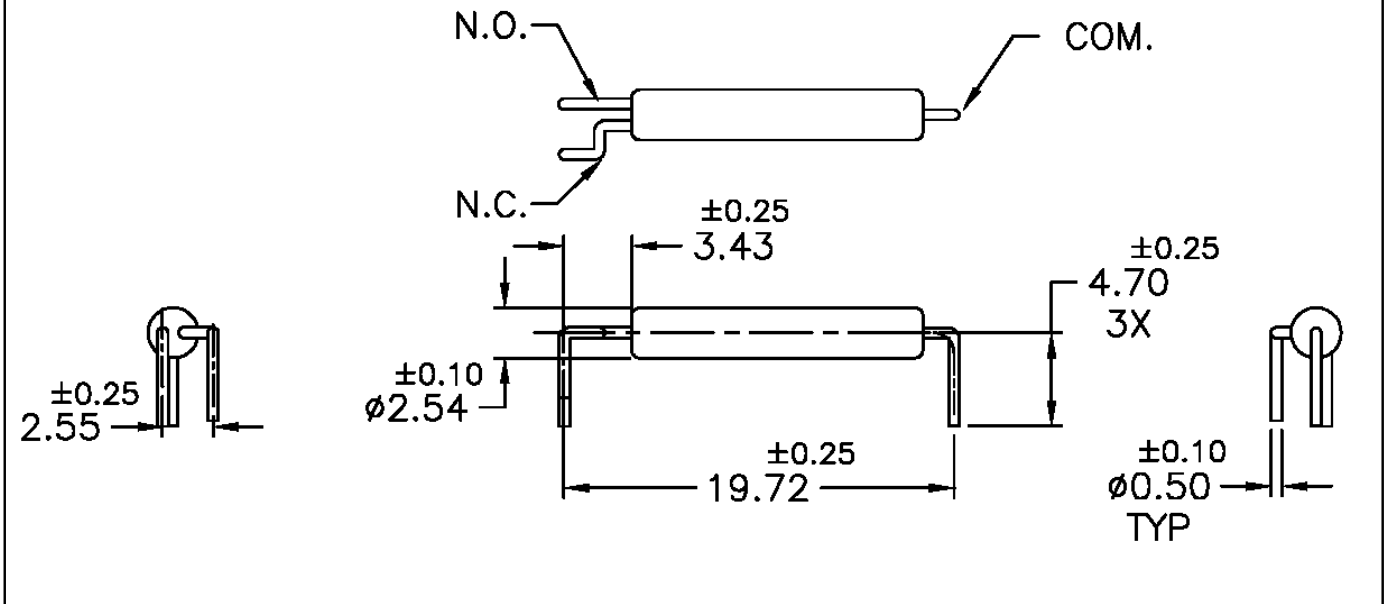

ISO 9001
N° 1993/1106a

celduc[®]
r e l a i s

www.celduc.com

Rue Ampère B.P. 4 42290 SORBIERS - FRANCE E-Mail : celduc-relais@celduc.com
 Fax +33 (0) 4 77 53 85 51 Service Commercial France Tél. : +33 (0) 4 77 53 90 20
 Sales Dept.For Europe Tel. : +33 (0) 4 77 53 90 21 Sales Dept. Asia : Tél. +33 (0) 4 77 53 90 19