

ADA4817-1/ADA4817-2

FEATURES

High speed

–3 dB bandwidth ($G = 1$, $R_L = 100 \Omega$): 1050 MHz

Slew rate: 870 V/ μ s

0.1% settling time: 9 ns

Low input bias current: 2 pA

Low input capacitance

Common-mode capacitance: 1.5 pF

Differential-mode capacitance: 0.1 pF

Low noise

4 nV/ $\sqrt{\text{Hz}}$ @ 100 kHz

2.5 fA/ $\sqrt{\text{Hz}}$ @ 100 kHz

Low distortion

–90 dBc @ 10 MHz ($G = 1$, $R_L = 1 \text{ k}\Omega$)

Offset voltage: 2 mV maximum

High output current: 70 mA

Supply current per amplifier: 19 mA

Power-down supply current per amplifier: 1 mA

APPLICATIONS

Photodiode amplifiers

Data acquisition front ends

Instrumentation

Filters

ADC drivers

CCD output buffers

GENERAL DESCRIPTION

The ADA4817-1 (single) and ADA4817-2 (dual) *FastFET*[™] amplifiers are unity-gain stable, ultrahigh speed voltage feedback amplifiers with FET inputs. These amplifiers are developed in the Analog Devices, Inc., proprietary eXtra Fast Complementary Bipolar (XFCB) process, which allows the amplifiers to achieve ultralow noise (4 nV/ $\sqrt{\text{Hz}}$; 2.5 fA/ $\sqrt{\text{Hz}}$) as well as very high input impedances.

With 1.5 pF of input capacitance, low noise (4 nV/ $\sqrt{\text{Hz}}$), low offset voltage (2 mV maximum), and 1050 MHz –3 dB bandwidth, the ADA4817-1/ADA4817-2 are ideal for data acquisition front ends as well as wideband transimpedance applications, such as photodiode preamps.

CONNECTION DIAGRAMS

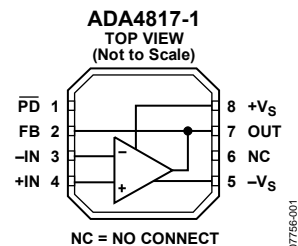

Figure 1. 8-Lead ADA4817-1 LFCSP (CP-8-2)

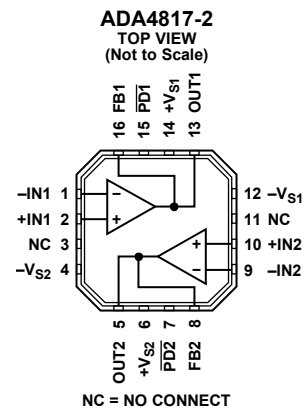

Figure 2. 16-Lead ADA4817-2 LFCSP (CP-16-4)

With a wide supply voltage range from 5 V to 10 V, the ability to operate on either single or dual supplies, the ADA4817-1/ADA4817-2 are designed to work in a variety of applications including active filtering and ADC driving.

The ADA4817-1 is available in a 3 mm × 3 mm 8-lead LFCSP and the ADA4817-2 is available in a 4 mm × 4 mm 16-lead LFCSP. Both packages feature a low distortion pinout, which improves second harmonic distortion and simplifies the layout of the circuit board. In addition, both packages feature an exposed paddle that provides a low thermal resistance path to the printed circuit board (PCB). This enables more efficient heat transfer and increases reliability. Both products are rated to work over the extended industrial temperature range (–40°C to +105°C).

Rev. 0

Information furnished by Analog Devices is believed to be accurate and reliable. However, no responsibility is assumed by Analog Devices for its use, nor for any infringements of patents or other rights of third parties that may result from its use. Specifications subject to change without notice. No license is granted by implication or otherwise under any patent or patent rights of Analog Devices. Trademarks and registered trademarks are the property of their respective owners.

TABLE OF CONTENTS

Features	1	Driving Capacitive Loads.....	14
Applications.....	1	Thermal Considerations.....	14
Connection Diagrams.....	1	Power-Down Operation	15
General Description	1	Capacitive Feedback.....	15
Revision History	2	Layout, Grounding, and Bypassing Considerations	16
Specifications.....	3	Signal Routing.....	16
±5 V Operation.....	3	Power Supply Bypassing.....	16
5 V Operation	4	Grounding	16
Absolute Maximum Ratings.....	5	Exposed Paddle.....	16
Thermal Resistance	5	Leakage Currents.....	17
Maximum Safe Power Dissipation	5	Input Capacitance	17
ESD Caution.....	5	Input-to-Input/Output Coupling.....	17
Pin Configurations and Function Descriptions	6	Applications Information	18
Typical Performance Characteristics	7	Low Distortion Pinout.....	18
Test Circuits.....	12	Wideband Photodiode Preamp	18
Theory of Operation	13	High Speed JFET Input Instrumentation Amplifier.....	20
Closed-Loop Frequency Response.....	13	Active Low-Pass Filter (LPF)	21
Noninverting Closed-Loop Frequency Response	13	Outline Dimensions	23
Inverting Closed-Loop Frequency Response	13	Ordering Guide	23
Wideband Operation	14		

REVISION HISTORY

11/08—Revision 0: Initial Version

SPECIFICATIONS

±5 V OPERATION

$T_A = 25^\circ\text{C}$, $G = 1$, $R_F = 348\ \Omega$ for $G > 1$, $R_L = 100\ \Omega$ to ground, unless otherwise noted.

Table 1.

Parameter	Conditions	Min	Typ	Max	Unit
DYNAMIC PERFORMANCE					
-3 dB Bandwidth	$V_{OUT} = 0.1\ \text{V p-p}$		1050		MHz
	$V_{OUT} = 2\ \text{V p-p}$		200		MHz
Gain Bandwidth Product	$V_{OUT} = 0.1\ \text{V p-p}$, $G = 2$		390		MHz
	$V_{OUT} = 0.1\ \text{V p-p}$		≥410		MHz
0.1 dB Flatness	$V_{OUT} = 2\ \text{V p-p}$, $R_L = 100\ \Omega$, $G = 2$		60		MHz
Slew Rate	$V_{OUT} = 4\ \text{V step}$		870		V/μs
Settling Time to 0.1%	$V_{OUT} = 2\ \text{V step}$, $G = 2$		9		ns
NOISE/HARMONIC PERFORMANCE					
Harmonic Distortion (HD2/HD3)	$f = 1\ \text{MHz}$, $V_{OUT} = 2\ \text{V p-p}$, $R_L = 1\ \text{k}\Omega$		-113/-117		dBc
	$f = 10\ \text{MHz}$, $V_{OUT} = 2\ \text{V p-p}$, $R_L = 1\ \text{k}\Omega$		-90/-94		dBc
	$f = 50\ \text{MHz}$, $V_{OUT} = 2\ \text{V p-p}$, $R_L = 1\ \text{k}\Omega$		-64/-66		dBc
Input Voltage Noise	$f = 100\ \text{kHz}$		4		nV/√Hz
Input Current Noise	$f = 100\ \text{kHz}$		2.5		fA/√Hz
DC PERFORMANCE					
Input Offset Voltage	T_{MIN} to T_{MAX}		0.4	2	mV
Input Offset Voltage Drift			7		μV/°C
Input Bias Current			2	20	pA
Input Bias Offset Current			100		pA
Open-Loop Gain			62	65	
INPUT CHARACTERISTICS					
Input Resistance	Common-mode		500		GΩ
Input Capacitance	Common-mode		1.5		pF
	Differential-mode		0.1		pF
Input Common-Mode Voltage Range			-5 to +2.3		V
Common-Mode Rejection	$V_{CM} = \pm 0.5\ \text{V}$	-77	-90		dB
OUTPUT CHARACTERISTICS					
Output Overdrive Recovery Time	$V_{IN} = \pm 2.5\ \text{V}$, $G = 2$		8		ns
Output Voltage Swing	$R_L = 1\ \text{k}\Omega$	-3.5 to +3.5	-3.6 to +3.7		V
		-3.9 to +3.9	-4.0 to +4.0		V
Linear Output Current			70		mA
Short-Circuit Current	Sinking/sourcing		100/170		mA
POWER-DOWN					
PD Pin Voltage	Enabled		>+V _S - 1		V
	Powered down		<+V _S - 3		V
Turn-On/Turn-Off Time			0.3/1		μs
Input Leakage Current	$\overline{PD} = +V_S$		0.3	3	μA
	$\overline{PD} = -V_S$		34	55	μA
POWER SUPPLY					
Operating Range		5		10	V
Quiescent Current per Amplifier			19	21	mA
Powered Down Quiescent Current			1.5	3	mA
Positive Power Supply Rejection	+V _S = 4.5 V to 5.5 V, -V _S = -5 V	-67	-72		dB
Negative Power Supply Rejection	+V _S = 5 V, -V _S = -4.5 V to -5.5 V	-67	-72		dB

ADA4817-1/ADA4817-2

5 V OPERATION

$T_A = 25^\circ\text{C}$, $+V_S = 3\text{ V}$, $-V_S = -2\text{ V}$, $G = 1$, $R_F = 348\ \Omega$ for $G > 1$, $R_L = 100\ \Omega$ to midsupply, unless otherwise noted.

Table 2.

Parameter	Conditions	Min	Typ	Max	Unit
DYNAMIC PERFORMANCE					
-3 dB Bandwidth	$V_{OUT} = 0.1\text{ V p-p}$		500		MHz
	$V_{OUT} = 1\text{ V p-p}$		160		MHz
	$V_{OUT} = 0.1\text{ V p-p}$, $G = 2$		280		MHz
0.1 dB Flatness	$V_{OUT} = 1\text{ V p-p}$, $G = 2$		32		MHz
Slew Rate	$V_{OUT} = 2\text{ V step}$		320		V/ μs
Settling Time to 0.1%	$V_{OUT} = 1\text{ V step}$, $G = 2$		11		ns
NOISE/HARMONIC PERFORMANCE					
Harmonic Distortion (HD2/HD3)	$f = 1\text{ MHz}$, $V_{OUT} = 1\text{ V p-p}$, $R_L = 1\text{ k}\Omega$		-87/-88		dBc
	$f = 10\text{ MHz}$, $V_{OUT} = 1\text{ V p-p}$, $R_L = 1\text{ k}\Omega$		-68/-66		dBc
	$f = 50\text{ MHz}$, $V_{OUT} = 1\text{ V p-p}$, $R_L = 1\text{ k}\Omega$		-57/-55		dBc
Input Voltage Noise	$f = 100\text{ kHz}$		4		nV/ $\sqrt{\text{Hz}}$
Input Current Noise	$f = 100\text{ kHz}$		2.5		fA/ $\sqrt{\text{Hz}}$
DC PERFORMANCE					
Input Offset Voltage			0.5	2.3	mV
Input Offset Voltage Drift			7		$\mu\text{V}/^\circ\text{C}$
Input Bias Current			2	20	pA
Input Bias Offset Current	T_{MIN} to T_{MAX}		100		pA
Open-Loop Gain		61	63		dB
INPUT CHARACTERISTICS					
Input Resistance	Common-mode		500		G Ω
Input Capacitance	Common-mode		1.3		pF
	Differential-mode		0.1		pF
Input Common-Mode Voltage Range			0 to 2.3		V
Common-Mode Rejection	$V_{CM} = \pm 0.25\text{ V}$	-72	-83		dB
OUTPUT CHARACTERISTICS					
Output Overdrive Recovery Time	$V_{IN} = \pm 1.25\text{ V}$, $G = 2$		13		ns
Output Voltage Swing		1.3 to 3.7	1 to 3.8		V
	$R_L = 1\text{ k}\Omega$	1 to 3.9	0.9 to 4.0		V
Linear Output Current			55		mA
Short-Circuit Current	Sinking/sourcing		40/130		mA
POWER-DOWN					
PD Pin Voltage	Enabled		$>+V_S - 1$		V
	Powered Down		$<+V_S - 3$		V
Turn-On/Turn-Off Time			0.2/0.7		μs
Input Leakage Current	$\overline{\text{PD}} = +V_S$		0.2	3	μA
	$\overline{\text{PD}} = -V_S$		31	45	μA
POWER SUPPLY					
Operating Range		5		10	V
Quiescent Current per Amplifier			14	15	mA
Powered Down Quiescent Current			1.5	2.5	mA
Positive Power Supply Rejection	$+V_S = 4.75\text{ V to }5.25\text{ V}$, $-V_S = 0\text{ V}$	-66	-71		dB
Negative Power Supply Rejection	$+V_S = 5\text{ V}$, $-V_S = -0.25\text{ V to }+0.25\text{ V}$	-63	-69		dB

ABSOLUTE MAXIMUM RATINGS

Table 3.

Parameter	Rating
Supply Voltage	10.6 V
Power Dissipation	See Figure 3
Common-Mode Input Voltage	-V _S - 0.5 V to +V _S + 0.5 V
Differential Input Voltage	±V _S
Storage Temperature Range	-65°C to +125°C
Operating Temperature Range	-40°C to +105°C
Lead Temperature (Soldering, 10 sec)	300°C
Junction Temperature	150°C

Stresses above those listed under Absolute Maximum Ratings may cause permanent damage to the device. This is a stress rating only; functional operation of the device at these or any other conditions above those indicated in the operational section of this specification is not implied. Exposure to absolute maximum rating conditions for extended periods may affect device reliability.

THERMAL RESISTANCE

θ_{JA} is specified for the worst-case conditions, that is, θ_{JA} is specified for a device soldered in circuit board for surface-mount packages.

Table 4.

Package Type	θ _{JA}	θ _{JC}	Unit
LFCSP_VD (ADA4817-1)	94	29	°C/W
LFSCP_VQ (ADA4817-2)	64	14	°C/W

MAXIMUM SAFE POWER DISSIPATION

The maximum safe power dissipation for the ADA4817-1/ADA4817-2 are limited by the associated rise in junction temperature (T_J) on the die. At approximately 150°C (which is the glass transition temperature), the properties of the plastic change. Even temporarily exceeding this temperature limit may change the stresses that the package exerts on the die, permanently shifting the parametric performance of the ADA4817. Exceeding a junction temperature of 175°C for an extended period can result in changes in silicon devices, potentially causing degradation or loss of functionality.

The power dissipated in the package (P_D) is the sum of the quiescent power dissipation and the power dissipated in the die due to the ADA4817-1/ADA4817-2 drive at the output. The quiescent power is the voltage between the supply pins (V_S) multiplied by the quiescent current (I_S).

$$P_D = \text{Quiescent Power} + (\text{Total Drive Power} - \text{Load Power}) \quad (1)$$

$$P_D = (V_S \times I_S) + \left(\frac{V_S}{2} \times \frac{V_{OUT}}{R_L} \right) - \frac{V_{OUT}^2}{R_L} \quad (2)$$

RMS output voltages should be considered. If R_L is referenced to -V_S, as in single-supply operation, the total drive power is V_S × I_{OUT}. If the rms signal levels are indeterminate, consider the worst-case scenario, when V_{OUT} = V_S/4 for R_L to midsupply.

$$P_D = (V_S \times I_S) + \frac{(V_S/4)^2}{R_L} \quad (3)$$

In single-supply operation with R_L referenced to -V_S, worst-case situation is V_{OUT} = V_S/2.

Airflow increases heat dissipation, effectively reducing θ_{JA}. More metal directly in contact with the package leads and exposed paddle from metal traces, throughholes, ground, and power planes also reduces θ_{JA}.

Figure 3 shows the maximum safe power dissipation in the package vs. the ambient temperature for the exposed paddle LFCSP_VD (single 94°C/W) and LFCSP_VQ (dual 64°C/W) package on a JEDEC standard 4-layer board. θ_{JA} values are approximations.

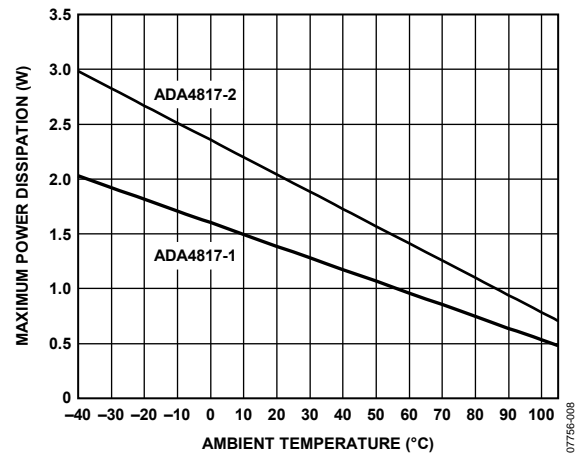

Figure 3. Maximum Safe Power Dissipation vs. Ambient Temperature for a 4-Layer Board

ESD CAUTION



ESD (electrostatic discharge) sensitive device. Charged devices and circuit boards can discharge without detection. Although this product features patented or proprietary protection circuitry, damage may occur on devices subjected to high energy ESD. Therefore, proper ESD precautions should be taken to avoid performance degradation or loss of functionality.

ADA4817-1/ADA4817-2

PIN CONFIGURATIONS AND FUNCTION DESCRIPTIONS

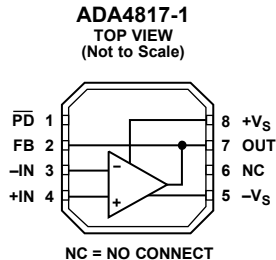

NOTES
1. EXPOSED PAD CAN BE CONNECTED TO GROUND PLANE OR NEGATIVE SUPPLY PLANE.

Figure 4. 8-Lead LFCSP Pin Configuration

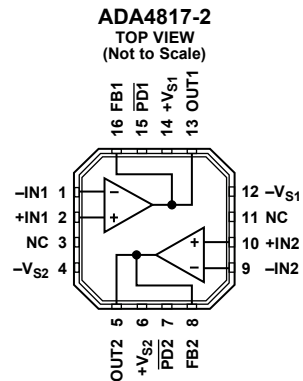

NOTES
1. EXPOSED PAD CAN BE CONNECTED TO THE GROUND PLANE OR NEGATIVE SUPPLY PLANE.

Figure 5. 16-Lead LFCSP Pin Configuration

Table 5. 8-Lead LFCSP Pin Function Descriptions

Pin No.	Mnemonic	Description
1	$\overline{\text{PD}}$	Power-Down. Do not leave floating.
2	FB	Feedback Pin.
3	-IN	Inverting Input.
4	+IN	Noninverting Input.
5	-Vs	Negative Supply.
6	NC	No Connect.
7	OUT	Output.
8	+Vs	Positive Supply.
9 (EPAD)	Exposed paddle (EPAD)	Exposed Pad. Can be connected to GND, -Vs plane or left floating.

Table 6. 16-Lead LFCSP Pin Function Descriptions

Pin No.	Mnemonic	Description
1	-IN1	Inverting Input 1.
2	+IN1	Noninverting Input 1.
3, 11	NC	No Connect.
4	-Vs2	Negative Supply 2.
5	OUT2	Output 2.
6	+Vs2	Positive Supply 2.
7	$\overline{\text{PD2}}$	Power-Down 2. Do not leave floating.
8	FB2	Feedback Pin 2.
9	-IN2	Inverting Input 2.
10	+IN2	Noninverting Input 2.
12	-Vs1	Negative Supply 1.
13	OUT1	Output 1.
14	+Vs1	Positive Supply 1.
15	$\overline{\text{PD1}}$	Power-Down 1. Do not leave floating.
16	FB1	Feedback Pin 1.
17 (EPAD)	Exposed paddle (EPAD)	Exposed Pad. Can be connected to GND, -Vs plane or left floating.

TYPICAL PERFORMANCE CHARACTERISTICS

$T_A = 25^\circ\text{C}$, $V_S = \pm 5\text{ V}$, $G = 1$, ($R_F = 348\ \Omega$ for $G > 1$), $R_L = 100\ \Omega$ to ground, small signal $V_{OUT} = 100\text{ mV p-p}$, large signal $V_{OUT} = 2\text{ V p-p}$, unless noted otherwise.

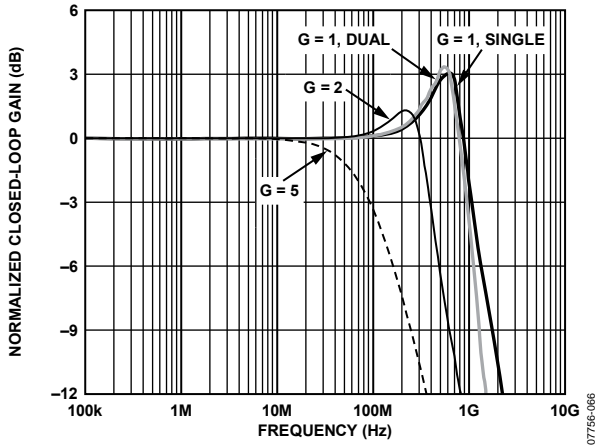

Figure 6. Small Signal Frequency Response for Various Gains

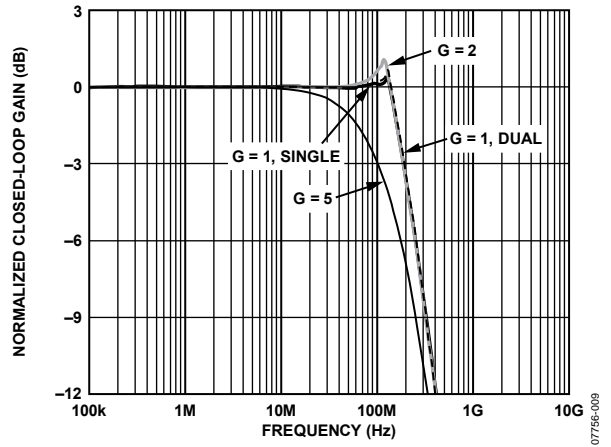

Figure 9. Large Signal Frequency Response for Various Gains

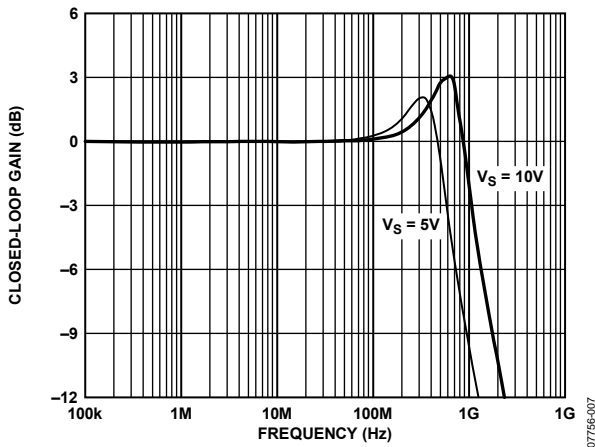

Figure 7. Small Signal Frequency Response for Various Supplies

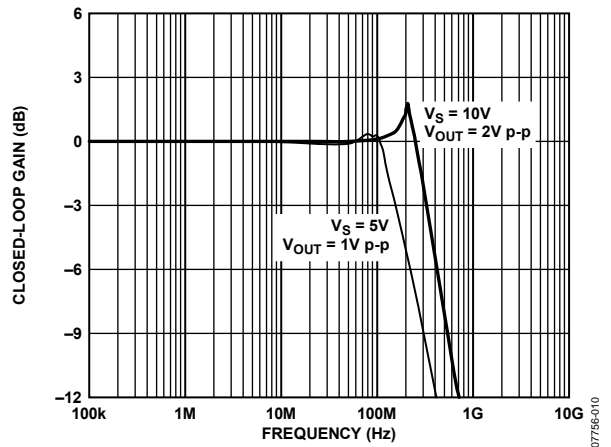

Figure 10. Large Signal Frequency Response for Various Supplies

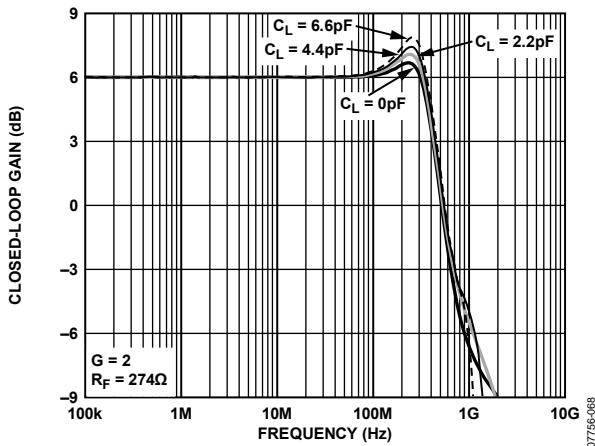

Figure 8. Small Signal Frequency Response for Various C_L

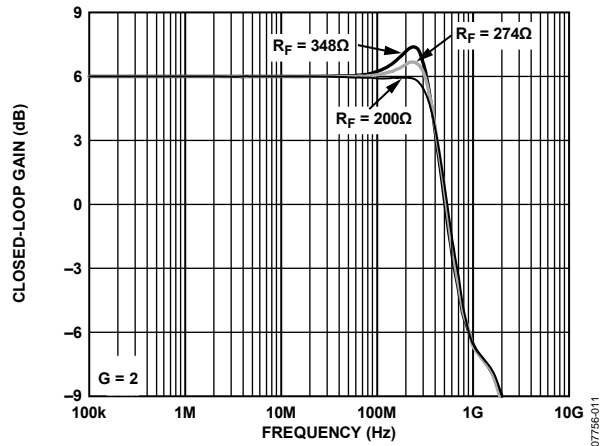

Figure 11. Small Signal Frequency Response for Various R_F

ADA4817-1/ADA4817-2

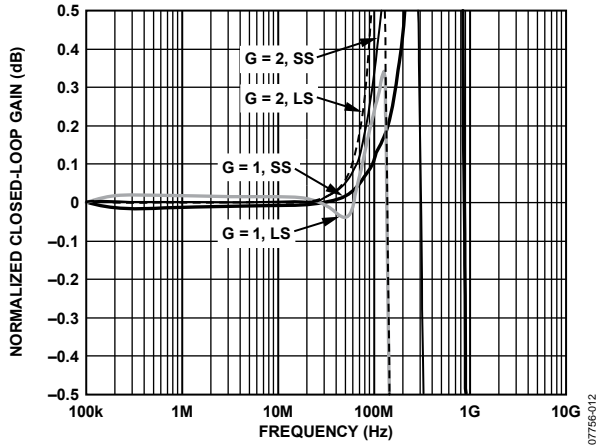

Figure 12. 0.1 dB Flatness Frequency Response vs. Gain and Output Voltage

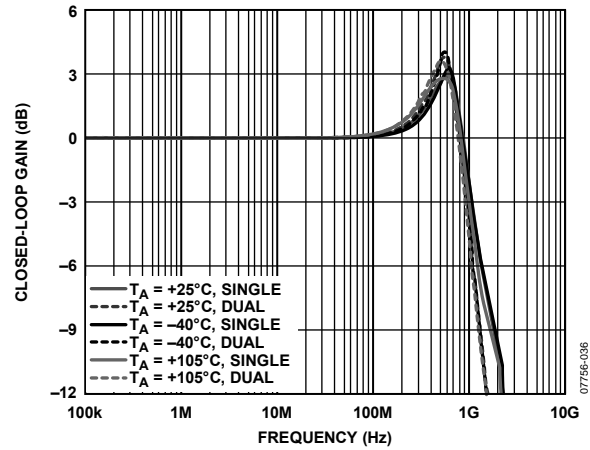

Figure 15. Small Signal Frequency Response vs. Temperature

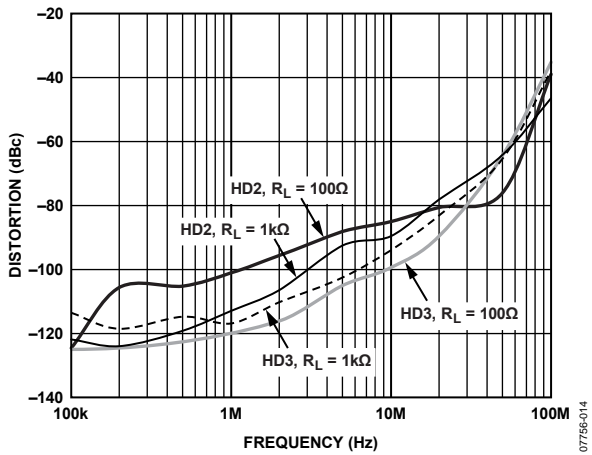

Figure 13. Distortion vs. Frequency for Various Loads, $V_{OUT} = 2\text{ V p-p}$

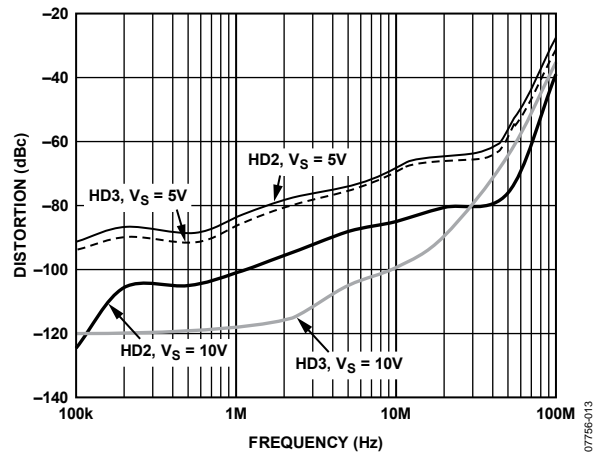

Figure 16. Distortion vs. Frequency for Various Supplies, $V_{OUT} = 2\text{ V p-p}$

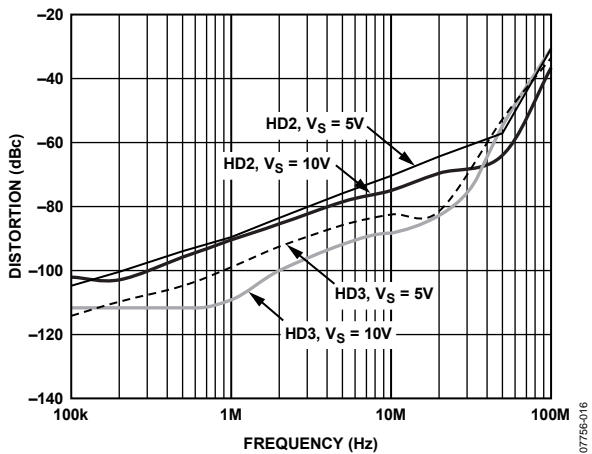

Figure 14. Distortion vs. Frequency for Various Supplies, $G = 2$, $V_{OUT} = 2\text{ V p-p}$

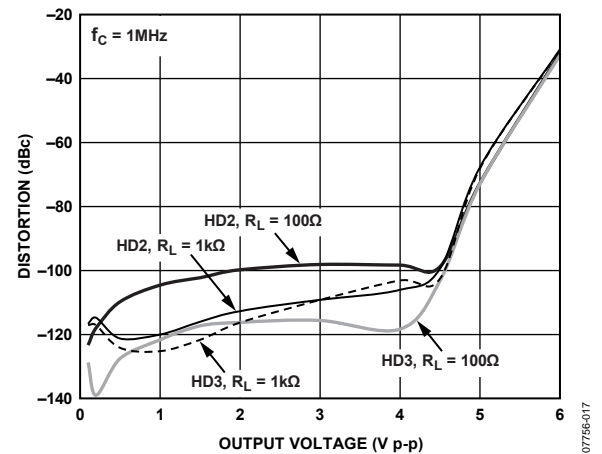

Figure 17. Distortion vs. Output Voltage for Various Loads

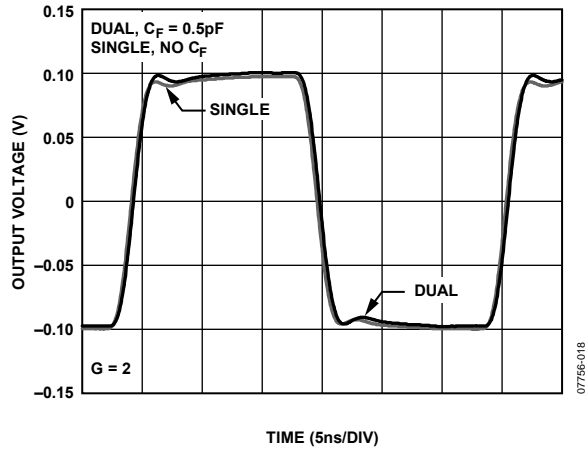

Figure 18. Small Signal Transient Response

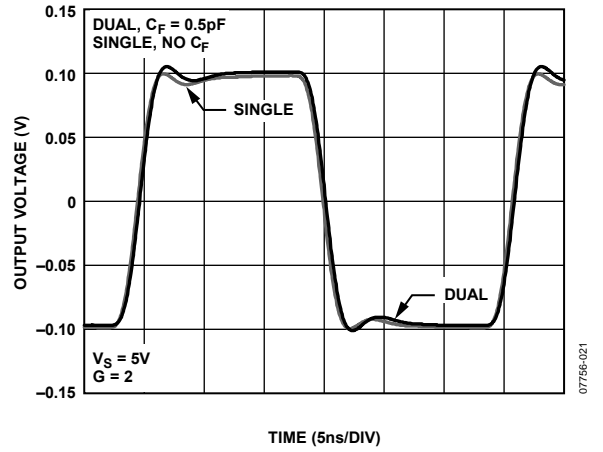

Figure 21. Small Signal Transient Response

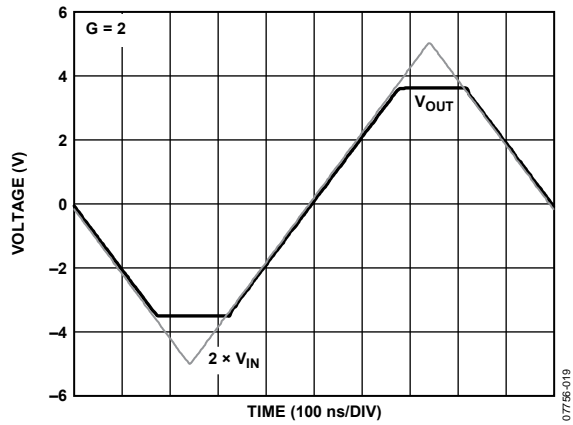

Figure 19. Output Overdrive Recovery

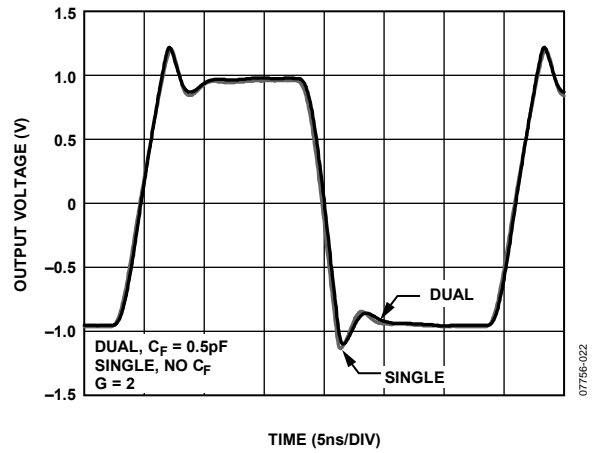

Figure 22. Large Signal Transient Response

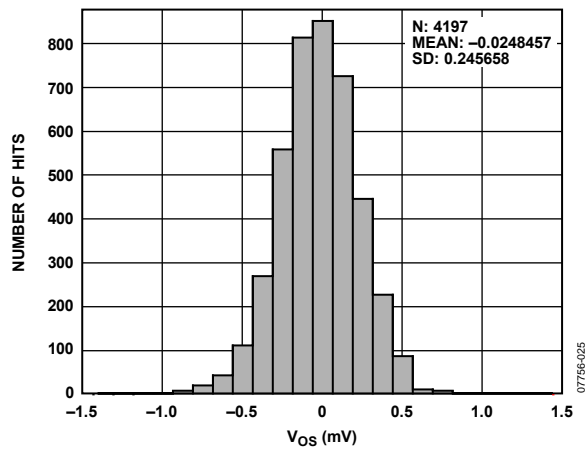

Figure 20. Input Offset Voltage Histogram

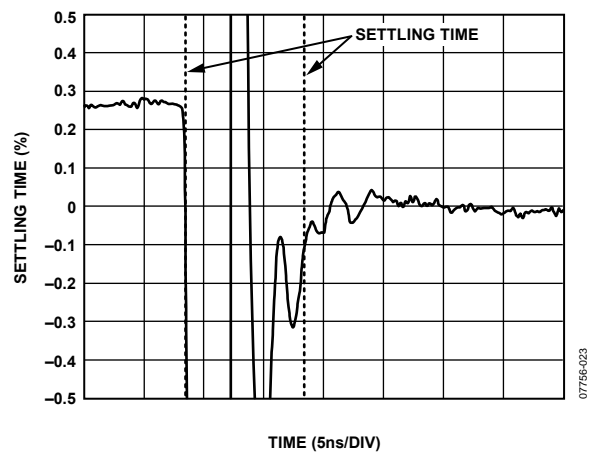

Figure 23. 0.1% Short-Term Settling Time

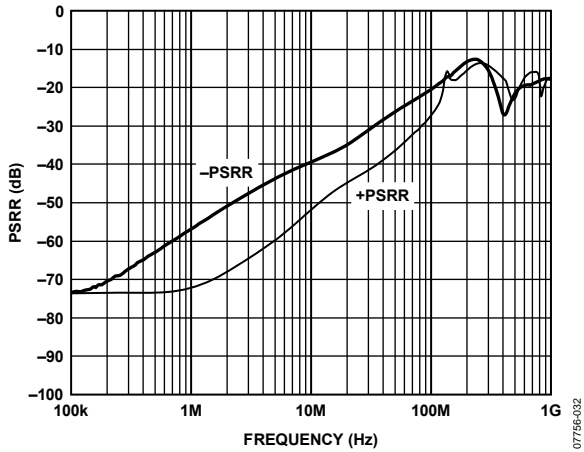

Figure 24. PSRR vs. Frequency

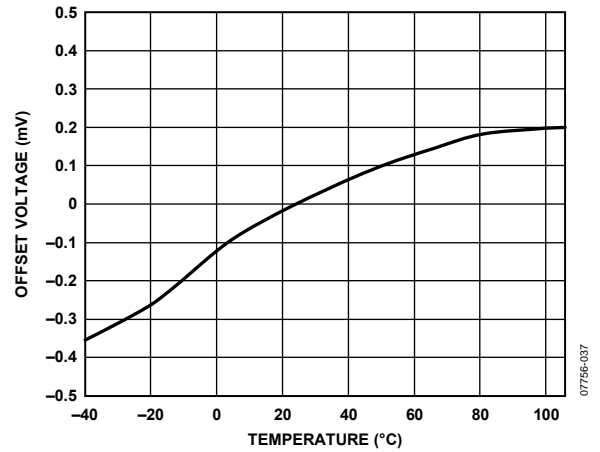

Figure 27. Offset Voltage vs. Temperature

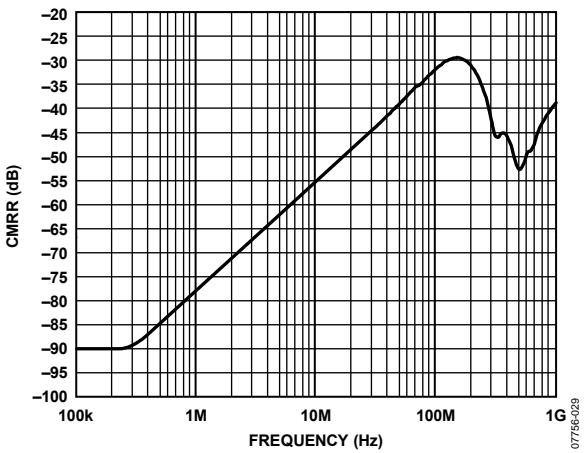

Figure 25. CMRR vs. Frequency

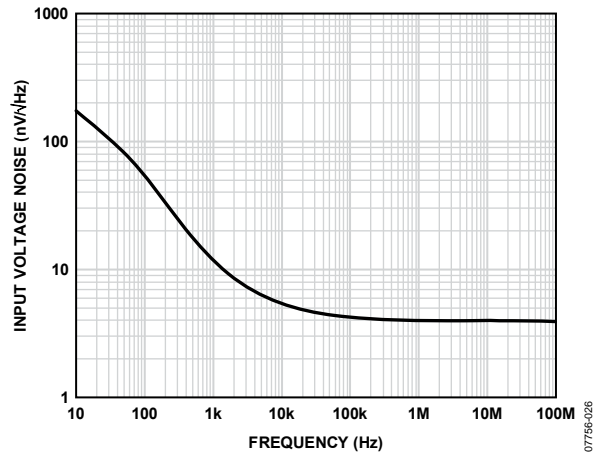

Figure 28. Input Voltage Noise

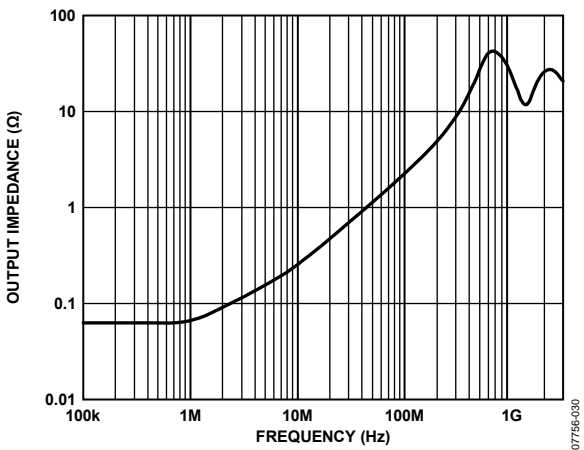

Figure 26. Output Impedance vs. Frequency

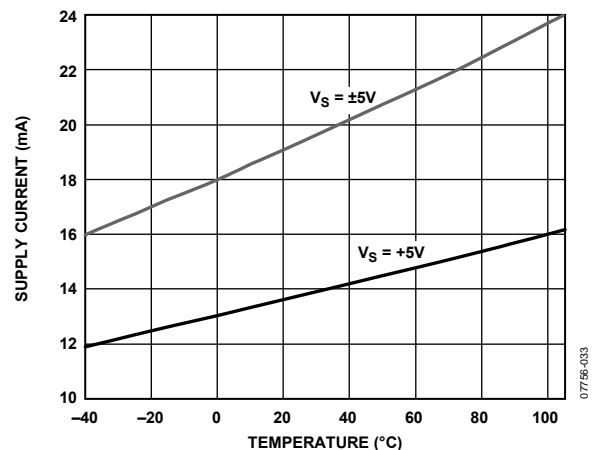

Figure 29. Quiescent Current vs. Temperature for Various Supply Voltages

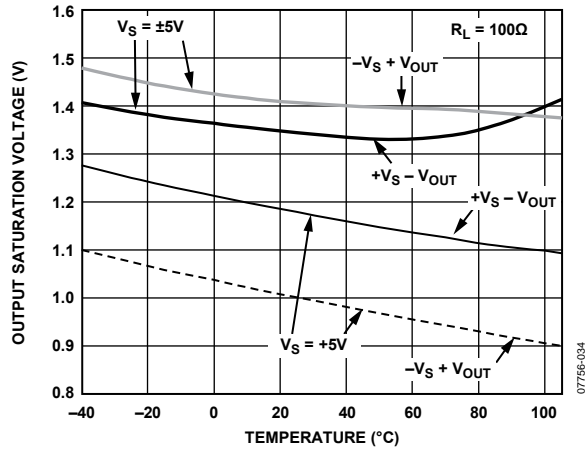

Figure 30. Output Saturation Voltage vs. Temperature

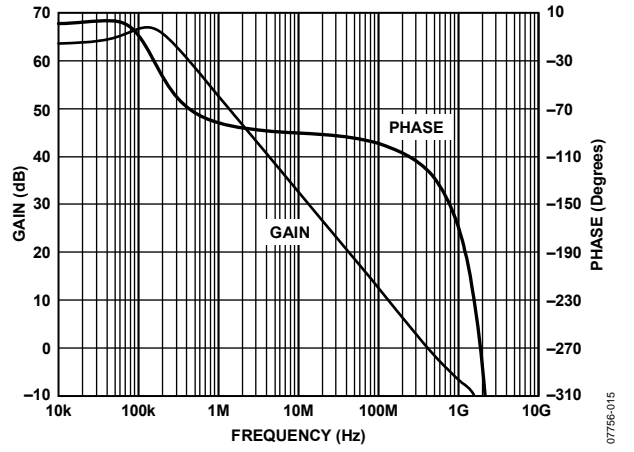

Figure 31. Open-Loop Gain and Phase vs. Frequency

TEST CIRCUITS

The output feedback pins are used for ease of layout in Figure 32 to Figure 37.

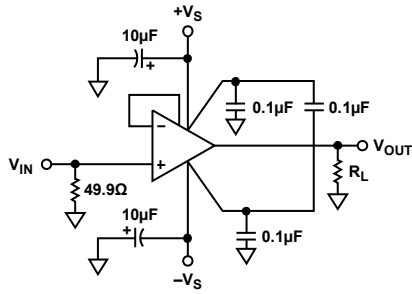

Figure 32. $G = 1$ Configuration

07756-147

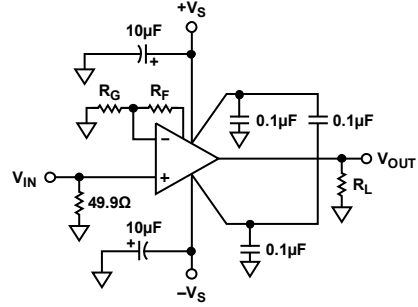

Figure 35. Noninverting Gain Configuration

07756-141

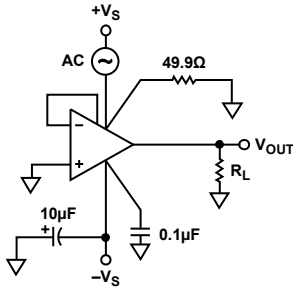

Figure 33. Positive Power Supply Rejection

07756-145

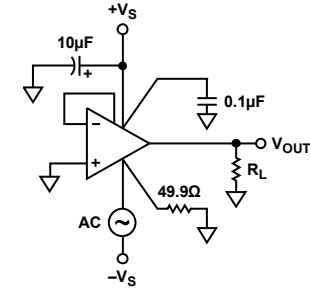

Figure 36. Negative Power Supply Rejection

07756-148

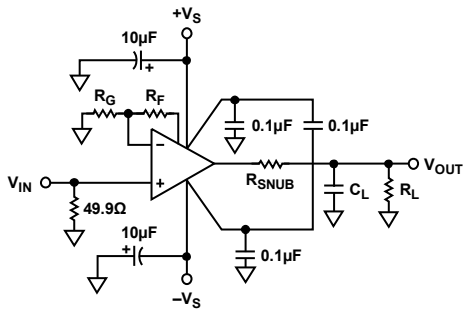

Figure 34. Capacitive Load Configuration

07756-142

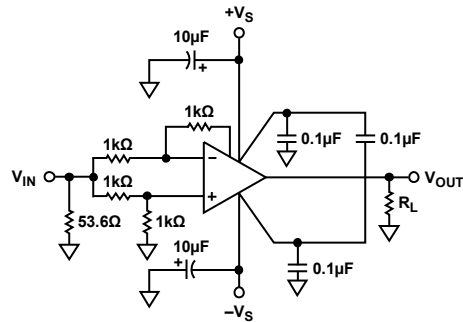

Figure 37. Common-Mode Rejection

07756-146

THEORY OF OPERATION

The ADA4817-1/ADA4817-2 are voltage feedback operational amplifiers that combine new architecture for FET input operational amplifiers with the eXtra Fast Complementary Bipolar (XFCB) process from Analog Devices resulting in an outstanding combination of speed and low noise. The innovative high speed FET input stage handles common-mode signals from the negative supply to within 2.3 V of the positive rail. This stage is combined with an H-bridge to attain a 870 V/μs slew rate and low distortion, in addition to 4 nV/√Hz input voltage noise. The amplifier features a high speed output stage capable of driving heavy loads sourcing and sinking up to 70 mA of linear current. Supply current and offset current are laser trimmed for optimum performance. These specifications make the ADA4817-1/ADA4817-2 a great choice for high speed instrumentation and high resolution data acquisition systems. Its low noise, picoamp input current, precision offset, and high speed make them superb preamps for fast photodiode applications.

CLOSED-LOOP FREQUENCY RESPONSE

The ADA4817-1/ADA4817-2 are classic voltage feedback amplifiers with an open-loop frequency response that can be approximated as the integrator response shown in Figure 40. Basic closed-loop frequency response for inverting and noninverting configurations can be derived from the schematics shown in Figure 38 and Figure 39.

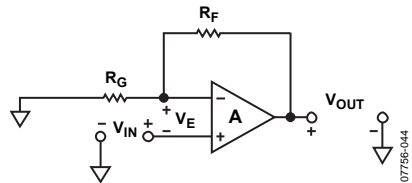

Figure 38. Noninverting Configuration

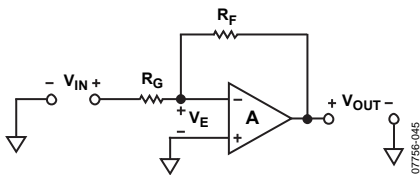

Figure 39. Inverting Configuration

NONINVERTING CLOSED-LOOP FREQUENCY RESPONSE

Solving for the transfer function,

$$\frac{V_O}{V_I} = \frac{2\pi \times f_{CROSSOVER} (R_G + R_F)}{(R_F + R_G)S + 2\pi \times f_{CROSSOVER} \times R_G} \quad (4)$$

where $f_{CROSSOVER}$ is the frequency where the amplifier's open-loop gain equals 0 dB.

$$\text{At dc } \frac{V_O}{V_I} = \frac{R_F + R_G}{R_G} \quad (5)$$

Closed-loop -3 dB frequency

$$f_{-3dB} = f_{CROSSOVER} \times \frac{R_G}{R_F + R_G} \quad (6)$$

INVERTING CLOSED-LOOP FREQUENCY RESPONSE

Solving for the transfer function,

$$\frac{V_O}{V_I} = \frac{-2\pi \times f_{CROSSOVER} \times R_F}{(R_F + R_G)S + 2\pi \times f_{CROSSOVER} \times R_G} \quad (7)$$

$$\text{At dc } \frac{V_O}{V_I} = -\frac{R_F}{R_G} \quad (8)$$

Solve for closed-loop -3 dB frequency by,

$$f_{-3dB} = f_{CROSSOVER} \times \frac{R_G}{R_F + R_G} \quad (9)$$

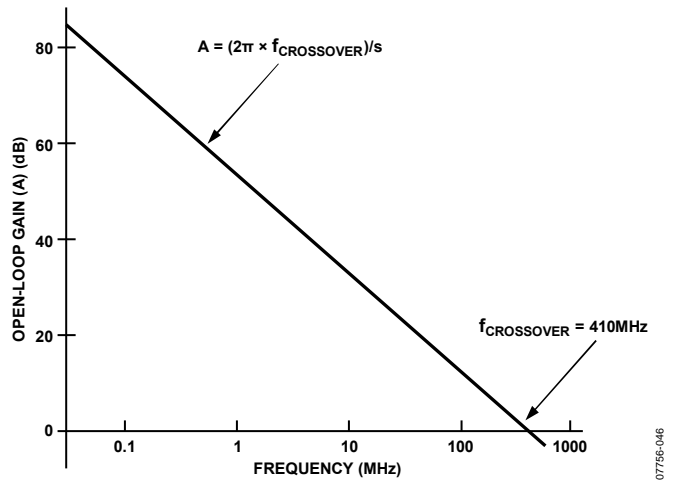

Figure 40. Open-Loop Gain vs. Frequency and Basic Connections

The closed-loop bandwidth is inversely proportional to the noise gain of the op amp circuit, $(R_F + R_G)/R_G$. This simple model is accurate for noise gains above 2. The actual bandwidth of circuits with noise gains at or below 2 is higher than those predicted with this model due to the influence of other poles in the frequency response of the real op amp.

Figure 41 shows a voltage feedback amplifier's dc errors. For both inverting and noninverting configurations,

$$V_{OUT} (error) = I_{b+} \times R_S \left(\frac{R_G + R_F}{R_G} \right) - I_{b-} \times R_F + V_{OS} \left(\frac{R_G + R_F}{R_G} \right) \quad (10)$$

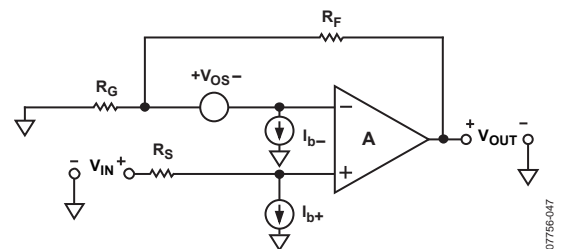

Figure 41. Voltage Feedback Amplifier's DC Errors

ADA4817-1/ADA4817-2

The voltage error due to I_{b+} and I_{b-} is minimized if $R_S = R_F \parallel R_G$ (though with the ADA4817-1/ADA4817-2 input currents in the picoamp range, this is likely not a concern). To include common-mode effects and power supply rejection effects, total V_{OS} can be modeled by

$$V_{OS} = V_{OSnom} + \frac{\Delta V_S}{PSR} + \frac{\Delta V_{CM}}{CMR} \quad (11)$$

where:

V_{OSnom} is the offset voltage specified at nominal conditions.

ΔV_S is the change in power supply from nominal conditions.

PSR is the power supply rejection.

ΔV_{CM} is the change in common-mode voltage from nominal conditions.

CMR is the common-mode rejection.

WIDEBAND OPERATION

The ADA4817-1/ADA4817-2 provides excellent performance as a high speed buffer. Figure 38 shows the circuit used for wideband characterization for high gains. The impedance at the summing junction ($R_F \parallel R_G$) forms a pole in the amplifier's loop response with the amplifier's input capacitance of 1.5 pF. This pole can cause peaking and ringing if its frequency is too low. Feedback resistances of 100 Ω to 400 Ω are recommended, because they minimize the peaking and they do not degrade the performance of the output stage. Peaking in the frequency response can also be compensated for with a small feedback capacitor (C_F) in parallel with the feedback resistor, or a series resistor in the noninverting input as shown in Figure 42.

The distortion performance depends on a number of variables:

- The closed-loop gain of the application
- Whether it is inverting or noninverting
- Amplifier loading
- Signal frequency and amplitude
- Board layout

The best performance is usually obtained in the $G + 1$ configuration with no feedback resistance, big output load resistors, and small board parasitic capacitances.

DRIVING CAPACITIVE LOADS

In general, high speed amplifiers have a difficult time driving capacitive loads. This is particularly true in low closed-loop gains, where the phase margin is the lowest. The difficulty arises because the load capacitance, C_L , forms a pole with the output resistance, R_O , of the amplifier. The pole can be described by the following equation:

$$f_p = \frac{1}{2\pi R_O C_L} \quad (12)$$

If this pole occurs too close to the unity-gain crossover point, the phase margin degrades. This is due to the additional phase loss associated with the pole.

Note that such capacitance introduces significant peaking in the frequency response. Larger capacitance values can be driven but must use a snubbing resistor (R_{SNUB}) at the output of the amplifier, as shown in Figure 42. Adding a small series resistor, R_{SNUB} , creates a zero that cancels the pole introduced by the load capacitance. Typical values for R_{SNUB} can range from 10 Ω to 50 Ω . The value is typically based on the circuit requirements. Figure 42 also shows another way to reduce the effect of the pole created by the capacitive load (C_L) by placing a capacitor (C_F) in the feedback loop parallel to the feedback resistor. Typical capacitor values can range from 0.5 pF to 2 pF. Figure 43 shows the effect of adding a feedback capacitor to the frequency response.

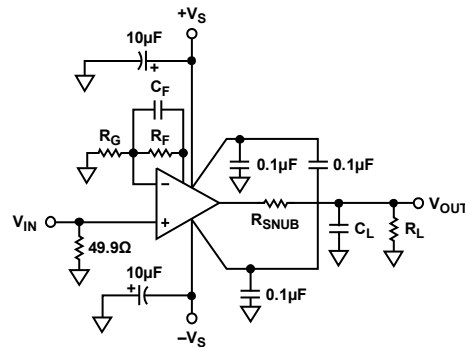

Figure 42. R_{SNUB} or C_F Used to Reduce Peaking

07/56-143

THERMAL CONSIDERATIONS

With 10 V power supplies and 19 mA quiescent current, the ADA4817-1/ADA4817-2 dissipate 190 mW with no load. This implies that in the LFCSP, whose thermal resistance is 94°C/W for the ADA4817-1 and 64°C/W for the ADA4817-2, the junction temperature is typically almost 25° higher than the ambient temperature. The ADA4817-1/ADA4817-2 are designed to maintain a constant bandwidth over temperature; therefore, an initial ramp up of the current consumption during warm-up is expected. The V_{OS} temperature drift is below 12 $\mu\text{V}/^\circ\text{C}$; therefore, it can change up to 0.3 mV due to warm-up effects for an ADA4817-1/ADA4817-2 in a LFCSP on 10 V. The input bias current increases by a factor of 1.7 for every 10°C rise in temperature.

Heavy loads increase power dissipation and raise the chip junction temperature as described in the Absolute Maximum Ratings section. Care should be taken not to exceed the rated power dissipation of the package.

POWER-DOWN OPERATION

The ADA4817-1/ADA4817-2 are equipped with separate power-down pins ($\overline{\text{PD}}$) pins for each amplifier. This allows the user the ability to reduce the quiescent supply current when an amplifier is inactive from 2 mA to 19 mA. The power-down threshold levels are derived from the voltage applied to the $+V_S$ pin. In ± 5 V supply application, the enable voltage is greater than +4 V, and in a ± 3 V supply application, the enable voltage is greater than +2 V. However, the amplifier is powered down whenever the voltage applied to the $\overline{\text{PD}}$ pin is 3 V below $+V_S$. If the $\overline{\text{PD}}$ pin is not to be used, it is best to connect it to the positive supply.

Table 7. Power-Down Voltage Control

PD Pin	± 5 V	+3 V, -2 V
Not active	>4 V	>2 V
Active	<2 V	<0 V

CAPACITIVE FEEDBACK

Due to package variations and pin-to-pin parasitic between the single and the dual, the ADA4817-2 has a little more peaking than the ADA4817-1, especially at a gain of 2. The best way to tame the peaking is to place a feedback capacitor across the feedback resistor.

Figure 43 shows the small signal frequency response of the ADA4817-2 at a gain of 2 vs. C_F . At first no C_F was used to show the peaking then two other values of 0.5 pF and 1 pF were used to show how to reduce the peaking or even eliminate it. As shown in Figure 43, if the power consumption is a factor in the system, then using a larger feedback capacitor is acceptable as long as a feedback capacitor is used across it to control the peaking. However, if the power consumption is not an issue, then a lower value feedback resistor such as 100 Ω , would not require any additional feedback capacitance to maintain flatness and lower peaking.

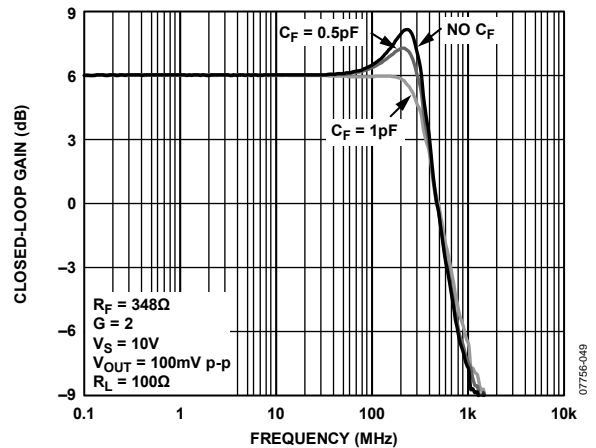

Figure 43. Small Signal Frequency Response vs. Feedback Capacitor (ADA4817-2)

LAYOUT, GROUNDING, AND BYPASSING CONSIDERATIONS

Laying out the PCB is usually the last step in the design process and often proves to be one of the most critical. A brilliant design can be rendered useless because of poor layout. Because the ADA4817-1/ADA4817-2 can operate into the RF frequency spectrum, high frequency board layout considerations must be taken into account. The PCB layout, signal routing, power supply bypassing, and grounding all must be addressed to ensure optimal performance.

SIGNAL ROUTING

The ADA4817-1/ADA4817-2 feature the new low distortion pinout with a dedicated feedback pin that allows a compact layout. The dedicated feedback pin reduces the distance from the output to the inverting input, which greatly simplifies the routing of the feedback network.

When laying out the ADA4817-1/ADA4817-2 as a unity-gain amplifier, it is recommended that a short, but wide, trace be placed between the dedicated feedback pins, and the inverting input to the amplifier be used to minimize stray parasitic inductance.

To minimize parasitic inductances, ground planes should be used under high frequency signal traces. However, the ground plane should be removed from under the input and output pins to minimize the formation of parasitic capacitors, which degrades phase margin. Signals that are susceptible to noise pickup should be run on the internal layers of the PCB, which can provide maximum shielding.

POWER SUPPLY BYPASSING

Power supply bypassing is a critical aspect of the PCB design process. For best performance, the ADA4817-1/ADA4817-2 power supply pins need to be properly bypassed.

A parallel connection of capacitors from each of the power supply pins to ground works best. Paralleling different values and sizes of capacitors helps to ensure that the power supply pins see a low ac impedance across a wide band of frequencies. This is important for minimizing the coupling of noise into the amplifier. Starting directly at the power supply pins, the smallest value and sized component should be placed on the same side of the board as the amplifier, and as close as possible to the amplifier, and connected to the ground plane. This process should be repeated for the next larger value capacitor. It is recommended that a 0.1 μF ceramic 0508 case be used for the ADA4817-1/ADA4817-2. The 0508 offers low series inductance and excellent high frequency performance. The 0.1 μF provides low impedance at high frequencies. A 10 μF electrolytic capacitor should be placed in parallel with the 0.1 μF . The 10 μF capacitor provides low ac impedance at low frequencies. Smaller values of electrolytic capacitors may be used depending on the circuit requirements. Additional smaller value capacitors help to provide a low impedance path for unwanted noise out to higher

frequencies but are not always necessary.

Placement of the capacitor returns (grounds) is also important. Returning the capacitors grounds close to the amplifier load is critical for distortion performance. Keeping the capacitors distance short but equal from the load is optimal for performance.

In some cases, bypassing between the two supplies can help to improve PSRR and to maintain distortion performance in crowded or difficult layouts. It is another option to improve performance.

Minimizing the trace length and widening the trace from the capacitors to the amplifier reduces the trace inductance. A series inductance with the parallel capacitance can form a tank circuit, which can introduce high frequency ringing at the output. This additional inductance can also contribute to increased distortion due to high frequency compression at the output. The use of vias should be minimized in the direct path to the amplifier power supply pins because vias can introduce parasitic inductance, which can lead to instability. When required to use vias, choose multiple large diameter vias because this lowers the equivalent parasitic inductance.

GROUNDING

The use of ground and power planes is encouraged as a method of providing low impedance returns for power supply and signal currents. Ground and power planes can also help to reduce stray trace inductance and to provide a low thermal path for the amplifier. Ground and power planes should not be used under any of the pins. The mounting pads and the ground or power planes can form a parasitic capacitance at the amplifier's input. Stray capacitance on the inverting input and the feedback resistor form a pole, which degrades the phase margin, leading to instability. Excessive stray capacitance on the output also forms a pole, which degrades phase margin.

EXPOSED PADDLE

The ADA4817-1/ADA4817-2 feature an exposed paddle, which lowers the thermal resistance by 25% compared to a standard SOIC plastic package. The exposed paddle of the ADA4817-1/ADA4817-2 floats internally which provides the maximum flexibility and ease of use. It can be connected to the ground plane or to the negative power supply plane. In cases where thermal heating is not an issue, the exposed pad could be left floating.

The use of thermal vias or heat pipes can also be incorporated into the design of the mounting pad for the exposed paddle. These additional vias help to lower the overall junction-to-ambient temperature (θ_{JA}). Using a heavier weight copper on the surface to which the amplifier's exposed paddle is soldered can greatly reduce the overall thermal resistance seen by the ADA4817-1/ADA4817-2.

LEAKAGE CURRENTS

Poor PCB layout, contaminants, and the board insulator material can create leakage currents that are much larger than the input bias current of the ADA4817-1/ADA4817-2. Any voltage differential between the inputs and nearby runs sets up leakage currents through the PCB insulator, for example, $1\text{ V}/100\text{ G}\Omega = 10\text{ pA}$. Similarly, any contaminants, such as skin oils on the board, can create significant leakage. To reduce leakage significantly, put a guard ring (shield) around the inputs and input leads that are driven to the same voltage potential as the inputs. This way there is no voltage potential between the inputs and surrounding area to set up any leakage currents. For the guard ring to be completely effective, it must be driven by a relatively low impedance source and should completely surround the input leads on all sides (above and below) while using a multilayer board.

Another effect that can cause leakage currents is the charge absorption of the insulator material itself. Minimizing the amount of material between the input leads and the guard ring helps to reduce the absorption. In addition, low absorption materials, such as Teflon® or ceramic, can be necessary in some instances.

INPUT CAPACITANCE

Along with bypassing and ground, high speed amplifiers can be sensitive to parasitic capacitance between the inputs and ground. A few picofarads of capacitance reduces the input impedance at high frequencies, in turn increasing the amplifier's gain, causing peaking of the frequency response or even oscillations if severe enough. It is recommended that the external passive components connected to the input pins be placed as close as possible to the inputs to avoid parasitic capacitance. The ground and power planes must be kept at a small distance from the input pins on all layers of the board.

INPUT-TO-INPUT/OUTPUT COUPLING

To minimize capacitive coupling between the inputs and outputs, the output signal traces should not be parallel with the inputs. In addition, the input traces should not be very close to each other. A minimum of 7 mils between the two inputs is recommended.

APPLICATIONS INFORMATION

LOW DISTORTION PINOUT

The ADA4817-1/ADA4817-2 feature a new low distortion pinout from Analog Devices. The new pinout provides two advantages over the traditional pinout. The first advantage is improved second harmonic distortion performance, which is accomplished by the physical separation of the noninverting input pin and the negative power supply pin. The second advantage is the simplification of the layout due to the dedicated feedback pin and easy routing of the gain set resistor back to the inverting input pin. This allows a compact layout, which helps to minimize parasitics and increase stability.

The designer does not need to use the dedicated feedback pin to provide feedback for the ADA4817-1/ADA4817-2. The output pin of the ADA4817-1/ADA4817-2 can still be used to provide feedback to the inverting input of the ADA4817-1/ADA4817-2.

WIDEBAND PHOTODIODE PREAMP

The wide bandwidth and low noise of the ADA4817-1/ADA4817-2 make it an ideal choice for transimpedance amplifiers, such as those used for signal conditioning with high speed photodiodes. Figure 44 shows an I/V converter with an electrical model of a photodiode. The basic transfer function is

$$V_{OUT} = \frac{I_{PHOTO} \times R_F}{1 + sC_F R_F} \quad (13)$$

where:

I_{PHOTO} is the output current of the photodiode.

The parallel combination of R_F and C_F sets the signal bandwidth.

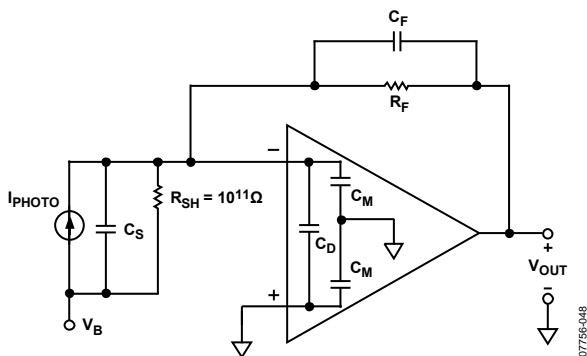

Figure 44. Wideband Photodiode Preamp

The stable bandwidth attainable with this preamp is a function of R_F , the gain bandwidth product of the amplifier, and the total capacitance at the amplifier's summing junction, including the photodiode capacitance (C_S) and the amplifier input capacitance. R_F and the total capacitance produce a pole in the amplifier's loop transmission that can result in peaking and instability. Adding C_F creates a zero in the loop transmission that compensates for the pole's effect and reduces the signal bandwidth. It can be shown that the signal bandwidth obtained with a 45° phase margin ($f_{(45)}$) is defined by

$$f_{(45)} = \sqrt{\frac{f_{CR}}{2\pi \times R_F \times (C_S + C_M + C_D)}} \quad (14)$$

where:

f_{CR} is the amplifier crossover frequency.

R_F is the feedback resistor.

C_S is the source capacitance including the photodiode and the board parasitic.

C_M is the common-mode capacitance of the amplifier.

C_D is the differential capacitance of the amplifier.

The value of C_F that produces $f_{(45)}$ can be shown to be

$$C_F = \sqrt{\frac{C_S + C_M + C_D}{2\pi \times R_F \times f_{CR}}} \quad (15)$$

The frequency response shows less peaking if bigger C_F values are used.

The preamplifier output noise over frequency is shown in Figure 45.

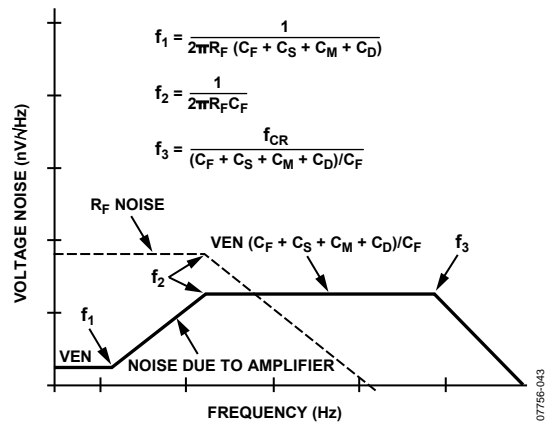

Figure 45. Photodiode Voltage Noise Contributions

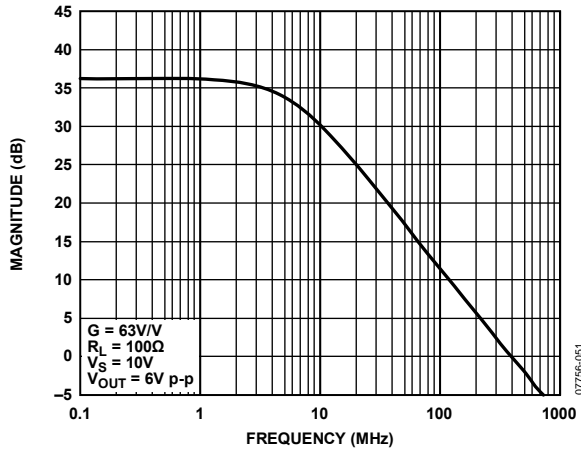

Figure 46. Photodiode Preamp Frequency Response

The pole in the loop transmission translates to a zero in the amplifier’s noise gain, leading to an amplification of the input voltage noise over frequency. The loop transmission zero introduced by C_F limits the amplification. The noise gain

bandwidth extends past the preamp signal bandwidth and is eventually rolled off by the decreasing loop gain of the amplifier. The current equivalent noise from the inverting terminal is typically negligible for most applications. The innovative architecture used in the ADA4817-1/ADA4817-2 makes balancing both inputs unnecessary, as opposed to traditional FET input amplifiers. Therefore, minimizing the impedance seen from the noninverting terminal to ground at all frequencies is critical for optimal noise performance.

Integrating the square of the output voltage noise spectral density over frequency and then taking the square root allows users to obtain the total rms output noise of the preamp. Table 8 summarizes approximations for the amplifier and feedback and source resistances. Noise components for an example preamp with $R_F = 50 \text{ k}\Omega$, $C_S = 30 \text{ pF}$, and $C_F = 0.5 \text{ pF}$ (bandwidth of about 6.4 MHz) are also listed.

Table 8. RMS Noise Contributions of Photodiode Preamp

Contributor	Expression	RMS Noise with $R_F = 50 \text{ k}\Omega$, $C_S = 30 \text{ pF}$, $C_F = 0.5 \text{ pF}$
R_F	$\sqrt{4kT \times R_F \times f_2 \times 1.57}$	94 μV
VEN Amp	$VEN \times \frac{C_S + C_M + C_D + C_F}{C_F} \times \sqrt{f_3 \times 1.57}$	777.5 μV
IEN Amp	$IEN \times R_F \times \sqrt{f_2 \times 1.57}$	0.4 μV
		783 μV (total)

ADA4817-1/ADA4817-2

HIGH SPEED JFET INPUT INSTRUMENTATION AMPLIFIER

Figure 47 shows an example of a high speed instrumentation amplifier with a high input impedance using the ADA4817-1/ADA4817-2. The dc transfer function is

$$V_{OUT} = (V_N - V_P) \left(1 + \frac{2R_F}{R_G} \right) \quad (16)$$

For $G = 1$, it is recommended that the feedback resistors for the two preamps be set to 0Ω and the gain resistor be open. The system bandwidth for $G = 1$ is 400 MHz. For gains higher than 2, the bandwidth is set by the preamp, and it can be

approximated by:

$$\text{In-amp}_{-3\text{dB}} = (f_{CR} \times R_G) / (2 \times R_F)$$

Common-mode rejection of the in-amp is primarily determined by the match of resistor ratios, $R1:R2$ to $R3:R4$. It can be estimated by

$$\frac{V_O}{V_{CM}} = \frac{(\delta 1 - \delta 2)}{(1 + \delta 1) \delta 2} \quad (17)$$

The summing junction impedance for the preamps is equal to $R_F \parallel 0.5(R_G)$. Keep this value relatively low to improve the bandwidth response like in the previous example.

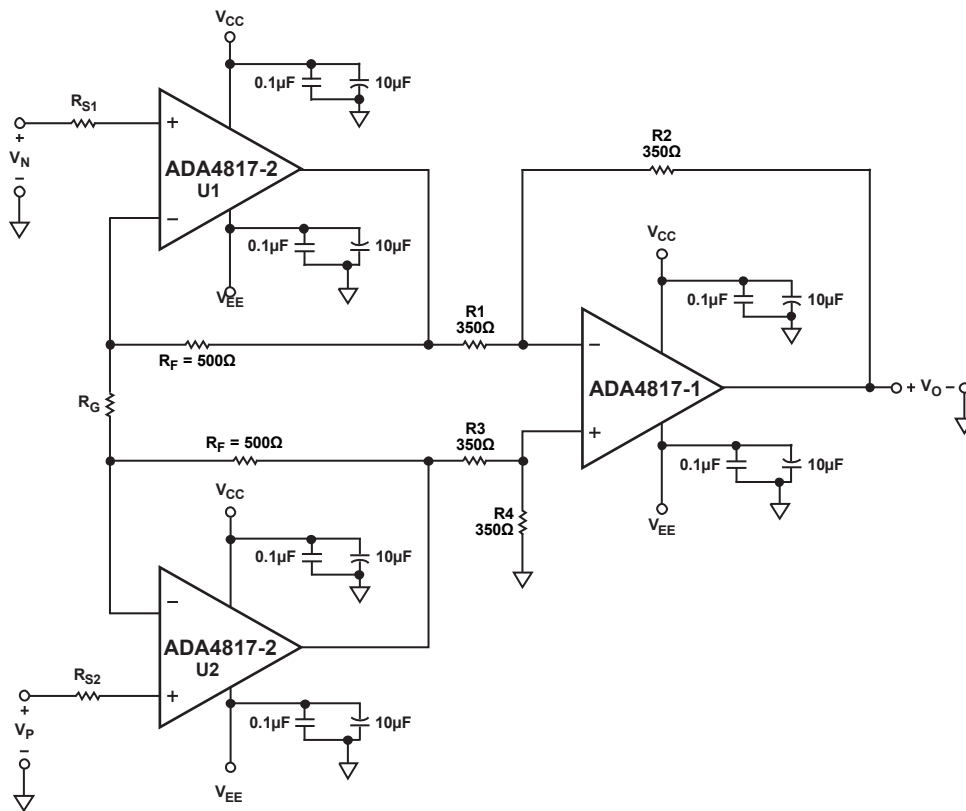

Figure 47. High Speed Instrumentation Amplifier

07756-050

ACTIVE LOW-PASS FILTER (LPF)

Active filters are used in many applications such as antialiasing filters and high frequency communication IF strips.

With a 410 MHz gain bandwidth product and high slew rate, the ADA4817-1/ADA4817-2 is an ideal candidate for active filters. Moreover, thanks to the low input bias current provided by the FET stage, the ADA4817-1/ADA4817-2 eliminate any dc errors. Figure 48 shows the frequency response of 90 MHz and 45 MHz LPFs. In addition to the bandwidth requirements, the slew rate must be capable of supporting the full power bandwidth of the filter. In this case, a 90 MHz bandwidth with a 2 V p-p output swing requires at least 870 V/ μ s. This performance is achievable at 90 MHz only because of the wide bandwidth and high slew rate of the ADA4817-1/ADA4817-2.

The circuit shown in Figure 49 is a 4-pole, Sallen-Key, low-pass filter (LPF). The filter comprises two identical cascaded Sallen-Key LPF sections, each with a fixed gain of $G = 2$. The net gain of the filter is equal to $G = 4$ or 12 dB. The actual gain shown in Figure 48 is 12 dB. This does not take into account the output voltage being divided in half by the series matching termination resistor, R_T , and the load resistor.

Setting the resistors equal to each other greatly simplifies the design equations for the Sallen-Key filter. To achieve 90 MHz the value of R should be set to 182 Ω . However, if the value of R is doubled, the corner frequency is cut in half to 45 MHz. This would be an easy way to tune the filter by simply multiplying the value of R (182 Ω) by the ratio of 90 MHz and the new corner frequency in megahertz. Figure 48 shows the output of each stage is of the filter and the two different filters corresponding to $R = 182 \Omega$ and $R = 365 \Omega$. It is not recommended to increase the corner frequency beyond 90 MHz due to bandwidth and slew rate limitations unless unity-gain stages are acceptable.

Resistor values are kept low for minimal noise contribution, offset voltage, and optimal frequency response. Due to the low capacitance values used in the filter circuit, the PCB layout and minimization of parasitics is critical. A few picofarads can detune the corner frequency, f_c , of the filter. The capacitor values shown in Figure 49 actually incorporate some stray PCB capacitance.

Capacitor selection is critical for optimal filter performance. Capacitors with low temperature coefficients, such as NPO ceramic capacitors and silver mica, are good choices for filter elements.

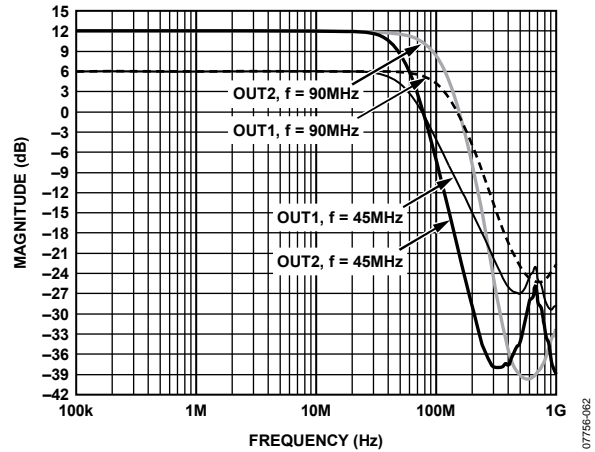

Figure 48. Low-Pass Filter Response

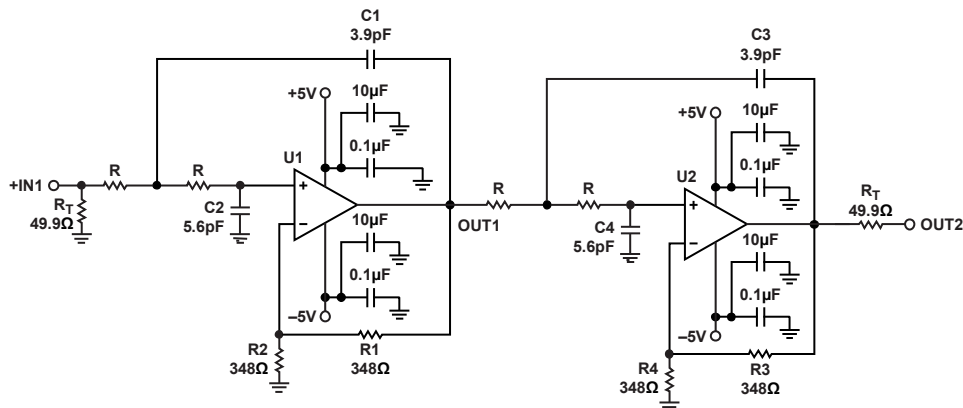

Figure 49. 4-Pole Sallen-Key Low-Pass Filter (ADA4817-2)

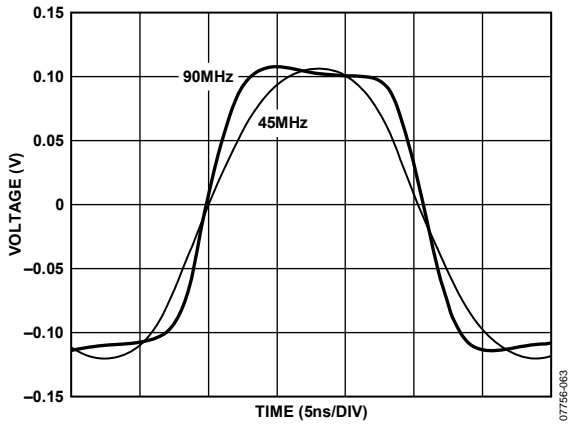

Figure 50. Small Signal Transient Response (Low-Pass Filter)

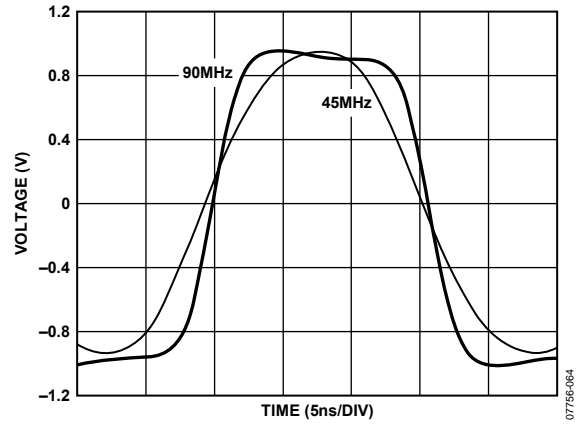

Figure 51. Large Signal Transient Response (Low-Pass Filter)

OUTLINE DIMENSIONS

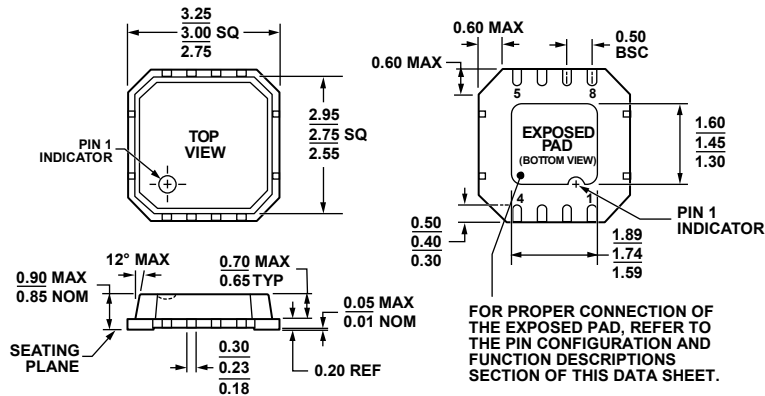
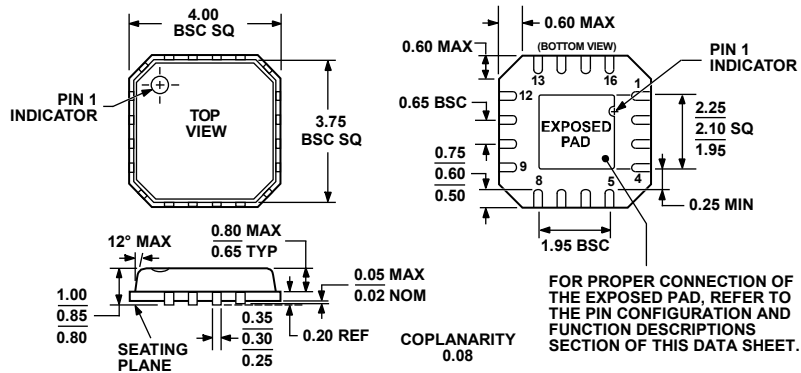

Figure 52. 8-Lead Lead Frame Chip Scale Package [LFCSP_VD]
 3 mm × 3 mm Body, Very Thin, Dual Lead (CP-8-2)
 Dimensions shown in millimeters



COMPLIANT TO JEDEC STANDARDS MO-220-VGGC
 Figure 53. 16-Lead Lead Frame Chip Scale Package [LFCSP_VQ]
 4 mm × 4 mm Body, Very Thin Quad (CP-16-4)
 Dimensions shown in millimeters

ORDERING GUIDE

Model	Temperature Range	Package Description	Package Option	Ordering Quantity	Branding
ADA4817-1ACPZ-R2 ¹	-40°C to +105°C	8-Lead LFCSP_VD	CP-8-2	250	H1F
ADA4817-1ACPZ-RL ¹	-40°C to +105°C	8-Lead LFCSP_VD	CP-8-2	5,000	H1F
ADA4817-1ACPZ-R7 ¹	-40°C to +105°C	8-Lead LFCSP_VD	CP-8-2	1,500	H1F
ADA4817-2ACPZ-R2 ¹	-40°C to +105°C	16-Lead LFCSP_VQ	CP-16-4	250	
ADA4817-2ACPZ-RL ¹	-40°C to +105°C	16-Lead LFCSP_VQ	CP-16-4	5,000	
ADA4817-2ACPZ-R7 ¹	-40°C to +105°C	16-Lead LFCSP_VQ	CP-16-4	1,500	

¹ Z = RoHS Compliant Part.

NOTES