

## Load Switch with Level-Shift

PRODUCT SUMMARY		
$V_{DS2}$ (V)	$r_{DS(on)}$ ( $\Omega$ )	$I_D$ (A)
1.8 to 20	0.165 at $V_{IN} = 4.5$ V	$\pm 1.2$
	0.222 at $V_{IN} = 2.5$ V	$\pm 1.0$
	0.303 at $V_{IN} = 1.8$ V	$\pm 0.7$

### FEATURES

- TrenchFET<sup>®</sup> Power MOSFETS: 1.8 V Rated
- ESD Protected: 2000 V On Input Switch,  $V_{ON/OFF}$
- 165 m $\Omega$  Low  $r_{DS(on)}$
- 1.8 to 20 V Input
- 1.5 to 8 V Logic Level Control
- Low Profile, Small Footprint SC70-6 Package
- Adjustable Slew-Rate



**RoHS**  
COMPLIANT

### APPLICATIONS

- Level Shift for Portable Devices

### DESCRIPTION

The Si1869DH includes a P- and N-Channel MOSFET in a single SC70-6 package. The low on-resistance P-Channel TrenchFET is tailored for use as a load switch. The N-Channel, with an external resistor, can be used as a level-shift to

drive the P-Channel load-switch. The N-Channel MOSFET has internal ESD protection and can be driven by logic signals as low as 1.5 V. The Si1869DH operates on supply lines from 1.8 to 20 V, and can drive loads up to 1.2 A.

### APPLICATION CIRCUITS

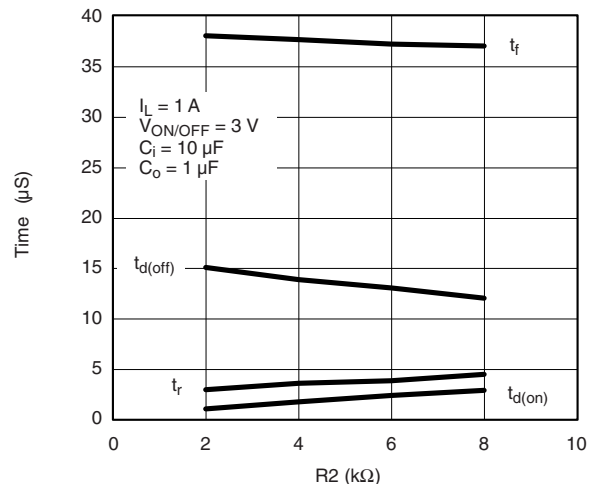
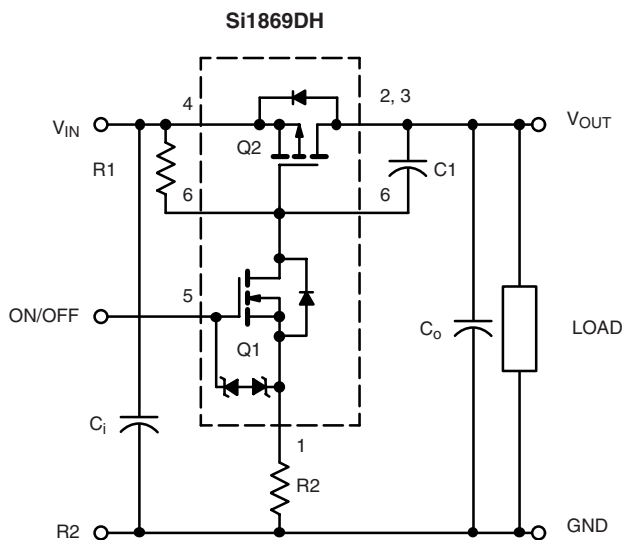

Note: For R2 switching variations with other  $V_{IN}/R1$  combinations See Typical Characteristics

**Switching Variation**  
R2 at  $V_{IN} = 2.5$  V,  $R1 = 20$  k $\Omega$

COMPONENTS		
R1	Pull-Up Resistor	Typical 10 k $\Omega$ to 1 Mega $\Omega$ *
R2	Optional Slew-Rate Control	Typical 0 to 100 k $\Omega$ *
C1	Optional Slew-Rate Control	Typical 1000 pF

\*Minimum R1 value should be at least 10 x R2 to ensure Q1 turn-on.

The Si1869DH is ideally suited for high-side load switching in portable applications. The integrated N-Channel level-shift device saves space by reducing external components. The slew rate is set externally so that rise-times can be tailored to different load types.

## FUNCTIONAL BLOCK DIAGRAM

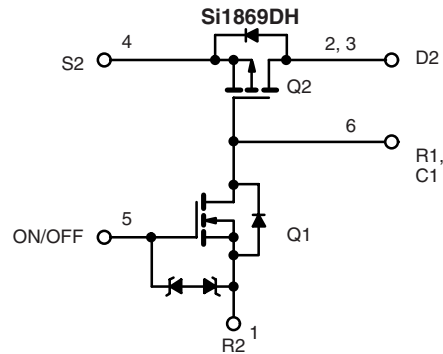
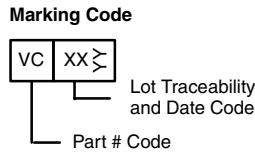
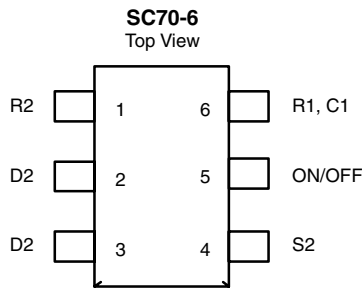

Ordering Information: Si1869DH-T1-E3 (Lead (Pb)-free)

ABSOLUTE MAXIMUM RATINGS $T_A = 25\text{ }^\circ\text{C}$ , unless otherwise noted			
Parameter	Symbol	Limit	Unit
Drain-Source Voltage (D2-S2)	$V_{DS}$	- 20	V
Input Voltage	$V_{IN}$	20	
ON/OFF Voltage	$V_{ON/OFF}$	8	
Load Current	Continuous <sup>a, b</sup>	$\pm 1.2$	A
	Pulsed <sup>b, c</sup>	$\pm 3$	
Continuous Intrinsic Diode Conduction <sup>a</sup>	$I_S$	- 0.4	
Maximum Power Dissipation <sup>a</sup>	$P_D$	1.0	W
Operating Junction and Storage Temperature Range	$T_J, T_{stg}$	- 55 to 150	$^\circ\text{C}$
ESD Rating, MIL-STD-883D Human Body Model (100 pF, 1500 $\Omega$ )	ESD	2	kV

THERMAL RESISTANCE RATINGS				
Parameter	Symbol	Typical	Maximum	Unit
Maximum Junction-to-Ambient (continuous current) <sup>a</sup>	$R_{thJA}$	100	125	$^\circ\text{C/W}$
Maximum Junction-to-Foot (Q2)	$R_{thJF}$	44	55	

SPECIFICATIONS $T_J = 25\text{ }^\circ\text{C}$ , unless otherwise noted						
Parameter	Symbol	Test Conditions	Min	Typ	Max	Unit
<b>OFF Characteristics</b>						
Reverse Leakage Current	$I_{FL}$	$V_{IN} = 8\text{ V}, V_{ON/OFF} = 0\text{ V}$			1	$\mu\text{A}$
Diode Forward Voltage	$V_{SD}$	$I_S = -0.4\text{ A}$	0.4	0.6	1.1	V
<b>ON Characteristics</b>						
Input Voltage Range	$V_{IN}$		1.8		20	V
Drain to Source Breakdown Voltage (P-Channel)	$V_{DS}$	$V_{GS} = 0\text{ V}, I_D = -250\text{ }\mu\text{A}$	- 20			
On-Resistance (P-Channel) at 1 A	$r_{DS(on)}$	$V_{ON/OFF} = 1.5\text{ V}, V_{IN} = 4.5\text{ V}, I_D = 1.2\text{ A}$		0.132	0.165	$\Omega$
		$V_{ON/OFF} = 1.5\text{ V}, V_{IN} = 2.5\text{ V}, I_D = 1.0\text{ A}$		0.177	0.222	
		$V_{ON/OFF} = 1.5\text{ V}, V_{IN} = 1.8\text{ V}, I_D = 0.7\text{ A}$		0.242	0.303	
On-State (P-Channel) Drain-Current	$I_{D(on)}$	$V_{IN-OUT} \leq 0.2\text{ V}, V_{IN} = 5\text{ V}, V_{ON/OFF} = 1.5\text{ V}$	1			A
		$V_{IN-OUT} \leq 0.3\text{ V}, V_{IN} = 3\text{ V}, V_{ON/OFF} = 1.5\text{ V}$	1			

Notes:

a. Surface Mounted on FR4 Board.

b.  $V_{IN} = 20\text{ V}, V_{ON/OFF} = 8\text{ V}, T_A = 25\text{ }^\circ\text{C}$ .

c. Pulse test: pulse width  $\leq 300\text{ }\mu\text{s}$ , duty cycle  $\leq 2\%$ .

Stresses beyond those listed under "Absolute Maximum Ratings" may cause permanent damage to the device. These are stress ratings only, and functional operation of the device at these or any other conditions beyond those indicated in the operational sections of the specifications is not implied. Exposure to absolute maximum rating conditions for extended periods may affect device reliability.

**TYPICAL CHARACTERISTICS** 25 °C, unless noted

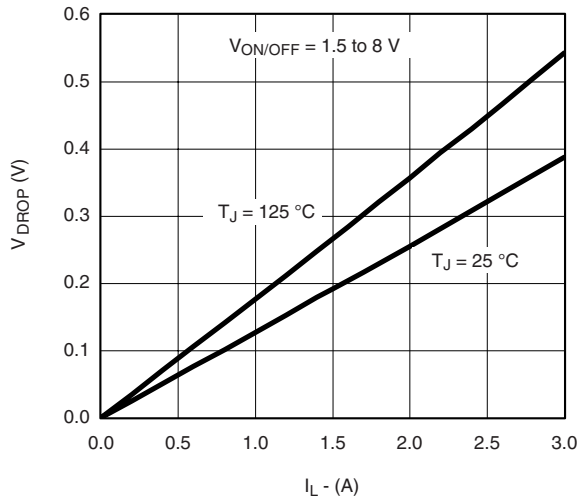

**$V_{DROP}$  vs.  $I_L$  at  $V_{IN} = 4.5 \text{ V}$**

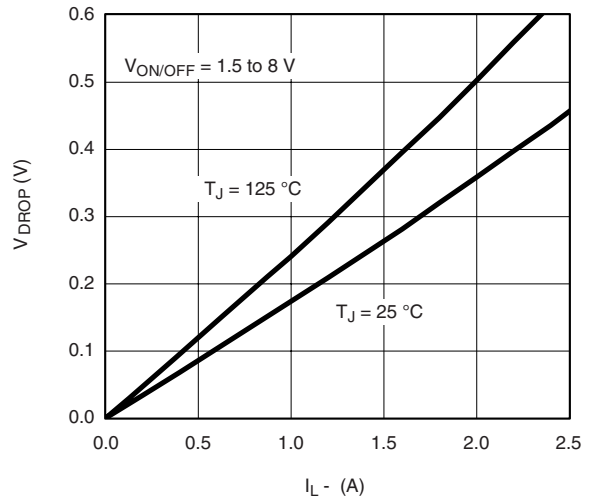

**$V_{DROP}$  vs.  $I_L$  at  $V_{IN} = 2.5 \text{ V}$**

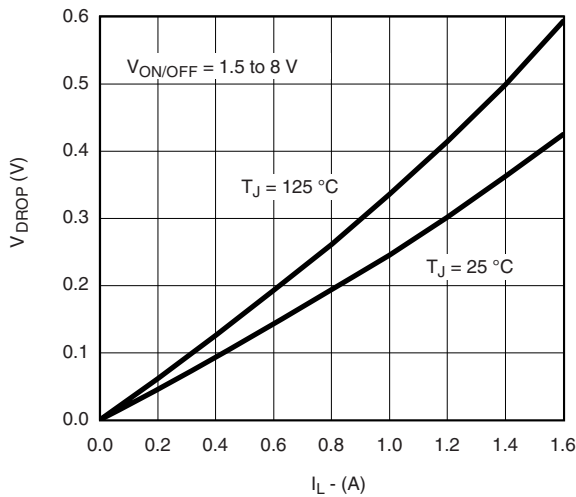

**$V_{DROP}$  vs.  $I_L$  at  $V_{IN} = 1.8 \text{ V}$**

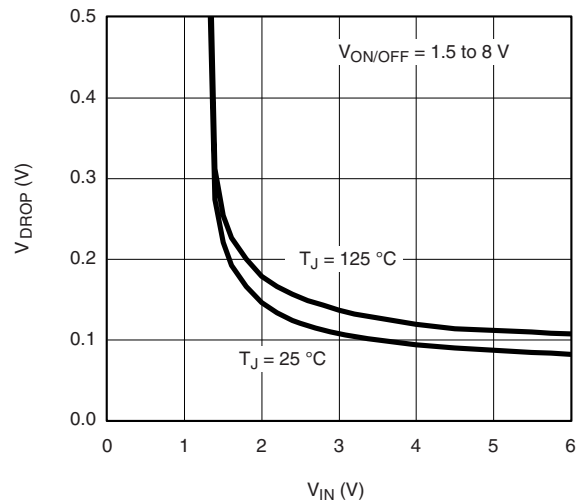

**$V_{DROP}$  vs.  $V_{IN}$  at  $I_L = 0.7 \text{ A}$**

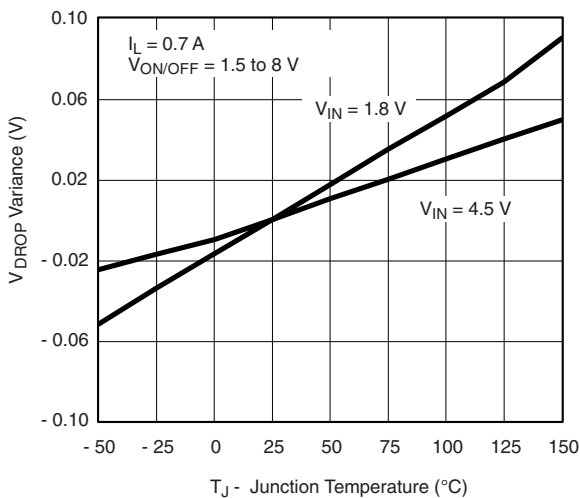

**$V_{DROP}$  Variance vs. Junction Temperature**

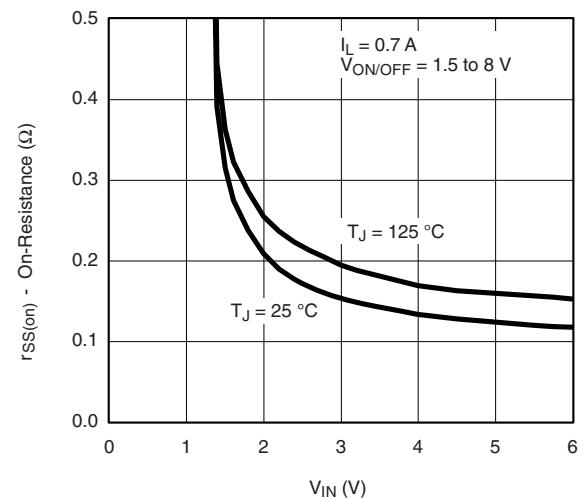

**On-Resistance vs. Input Voltage**

**TYPICAL CHARACTERISTICS** 25 °C, unless noted

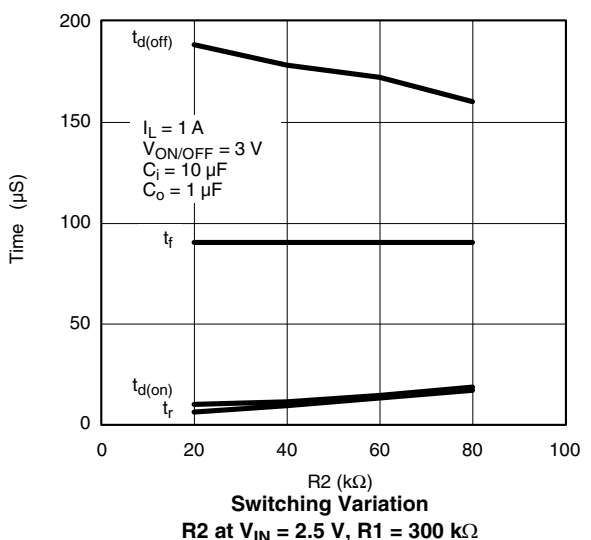
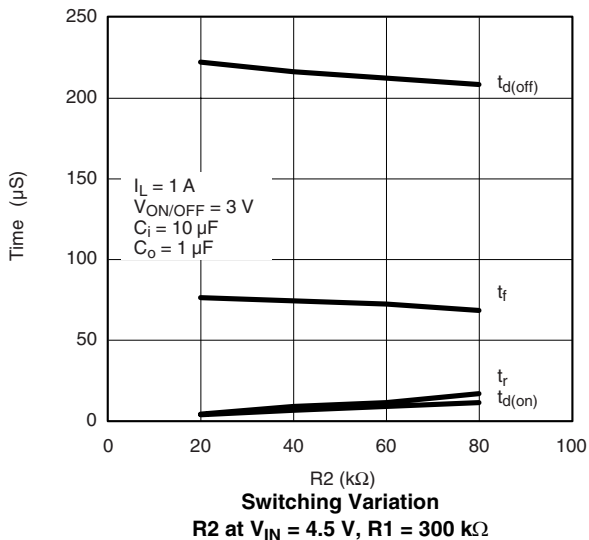
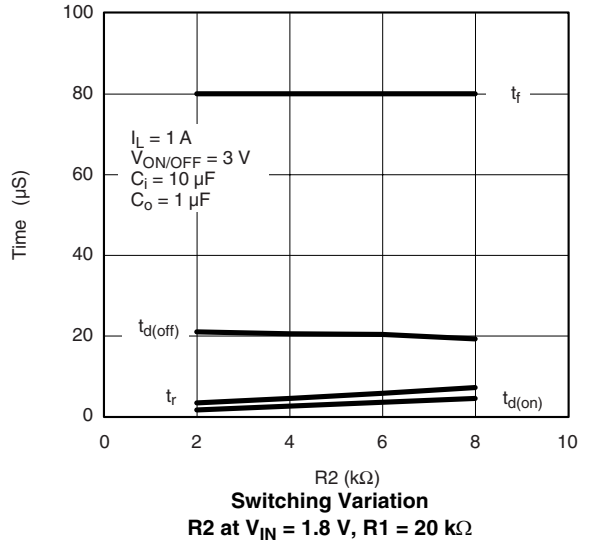
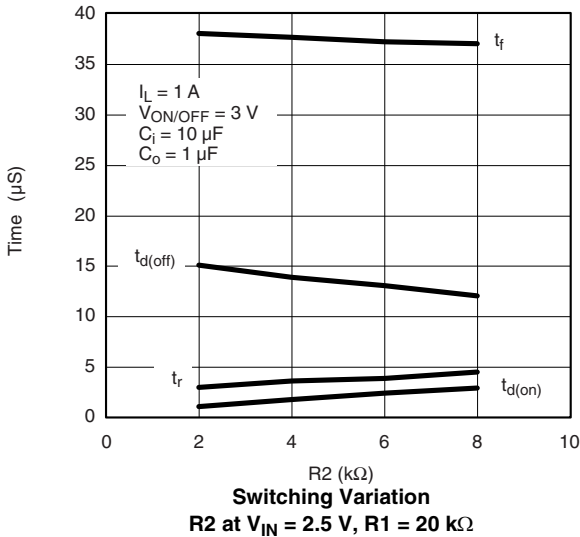
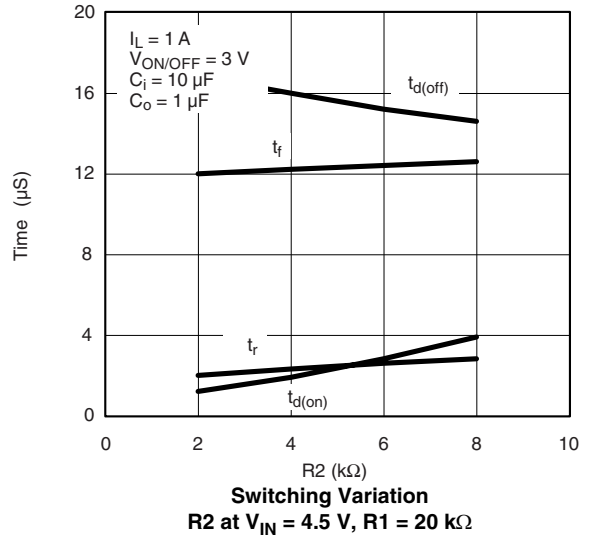
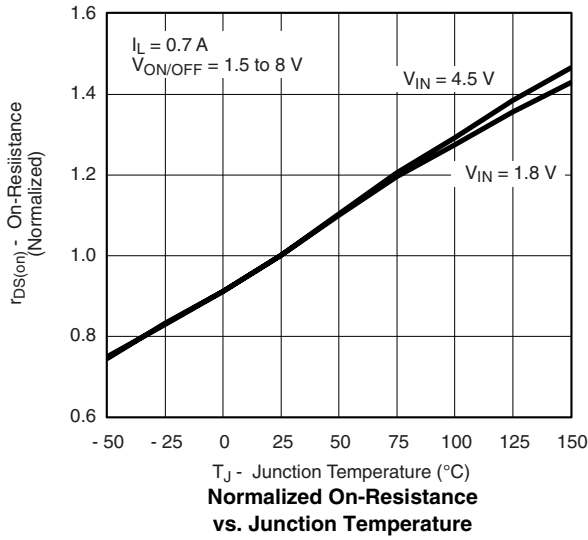

**TYPICAL CHARACTERISTICS** 25 °C, unless noted

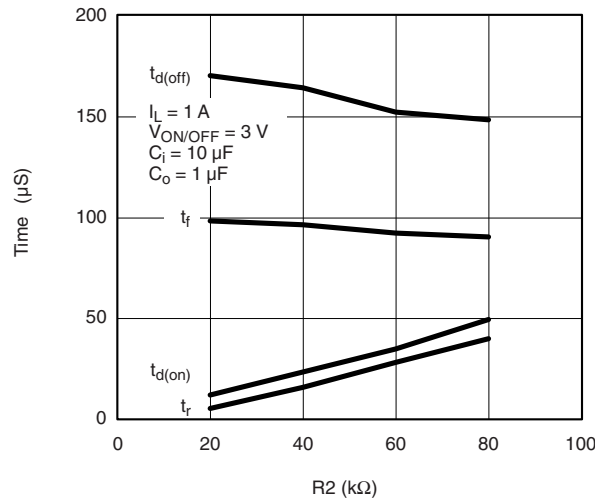

**Switching Variation**  
R2 at  $V_{IN} = 1.8\text{ V}$ ,  $R1 = 300\ \text{k}\Omega$

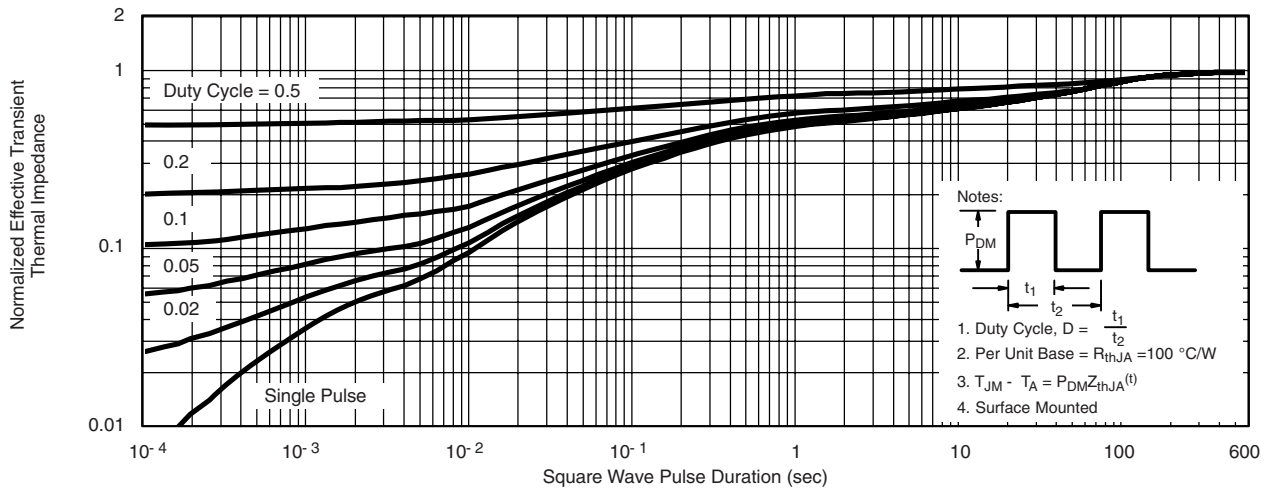

**Normalized Thermal Transient Impedance, Junction-to-Ambient**

## TYPICAL CHARACTERISTICS 25 °C, unless noted

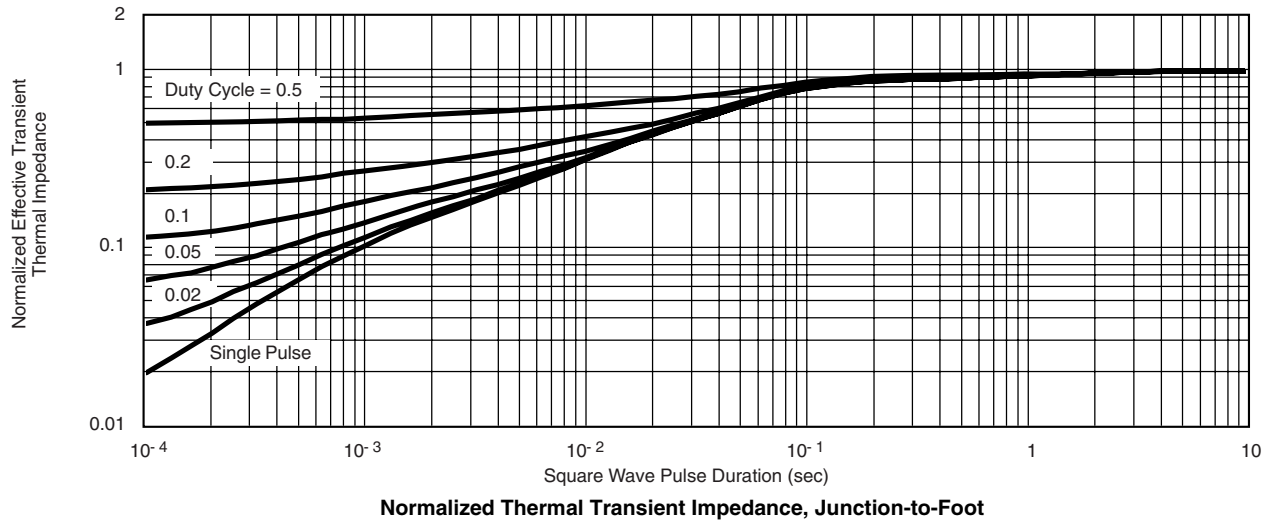

Vishay Siliconix maintains worldwide manufacturing capability. Products may be manufactured at one of several qualified locations. Reliability data for Silicon Technology and Package Reliability represent a composite of all qualified locations. For related documents such as package/tape drawings, part marking, and reliability data, see <http://www.vishay.com/ppg?73449>.



## Disclaimer

All product specifications and data are subject to change without notice.

Vishay Intertechnology, Inc., its affiliates, agents, and employees, and all persons acting on its or their behalf (collectively, "Vishay"), disclaim any and all liability for any errors, inaccuracies or incompleteness contained herein or in any other disclosure relating to any product.

Vishay disclaims any and all liability arising out of the use or application of any product described herein or of any information provided herein to the maximum extent permitted by law. The product specifications do not expand or otherwise modify Vishay's terms and conditions of purchase, including but not limited to the warranty expressed therein, which apply to these products.

No license, express or implied, by estoppel or otherwise, to any intellectual property rights is granted by this document or by any conduct of Vishay.

The products shown herein are not designed for use in medical, life-saving, or life-sustaining applications unless otherwise expressly indicated. Customers using or selling Vishay products not expressly indicated for use in such applications do so entirely at their own risk and agree to fully indemnify Vishay for any damages arising or resulting from such use or sale. Please contact authorized Vishay personnel to obtain written terms and conditions regarding products designed for such applications.

Product names and markings noted herein may be trademarks of their respective owners.