

RQK0607AQDQS

Silicon N Channel MOS FET
Power Switching

REJ03G1620-0100

Rev.1.00

Mar 03, 2008

Features

- Low on-resistance
 $R_{DS(on)} = 210 \text{ m}\Omega$ typ.(at $V_{GS} = 4.5 \text{ V}$, $I_D = 1.2 \text{ A}$)
- Low drive current
- High speed switching
- $V_{DSS} : 60 \text{ V}$ and capable of 2.5 V gate drive

Outline

RENESAS package code: PLZZ0004CA-A
(Package name: UPAK®)

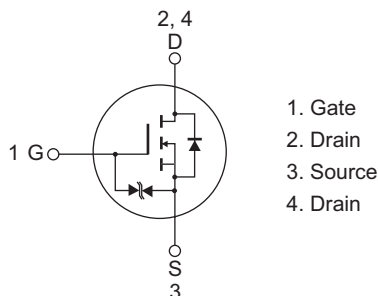
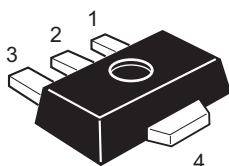

Note: Marking is "AQ".

Absolute Maximum Ratings

($T_a = 25^\circ\text{C}$)

Item	Symbol	Ratings	Unit
Drain to source voltage	V_{DSS}	60	V
Gate to source voltage	V_{GSS}	± 12	V
Drain current	I_D	2.4	A
Drain peak current	$I_{D(pulse)}$ ^{Note1}	8	A
Body - drain diode reverse drain current	I_{DR}	2.4	A
Channel dissipation	P_{ch} ^{Note2}	1.5	W
Channel temperature	T_{ch}	150	$^\circ\text{C}$
Storage temperature	T_{stg}	-55 to +150	$^\circ\text{C}$

Notes: 1. $PW \leq 10 \mu\text{s}$, Duty cycle $\leq 1\%$

2. When using the glass epoxy board (FR-4 40 × 40 × 1 mm)

Electrical Characteristics

(Ta = 25°C)

Item	Symbol	Min	Typ	Max	Unit	Test conditions
Drain to source breakdown voltage	$V_{(BR)DSS}$	60	—	—	V	$I_D = 10 \text{ mA}$, $V_{GS} = 0$
Gate to source breakdown voltage	$V_{(BR)GSS}$	+12	—	—	V	$I_G = +100 \text{ } \mu\text{A}$, $V_{DS} = 0$
Gate to source breakdown voltage	$V_{(BR)GSS}$	-12	—	—	V	$I_G = -100 \text{ } \mu\text{A}$, $V_{DS} = 0$
Gate to source leak current	I_{GSS}	—	—	+10	μA	$V_{GS} = +10 \text{ V}$, $V_{DS} = 0$
Gate to source leak current	I_{GSS}	—	—	-10	μA	$V_{GS} = -10 \text{ V}$, $V_{DS} = 0$
Zero gate voltage drain current	I_{DSS}	—	—	1	μA	$V_{DS} = 60 \text{ V}$, $V_{GS} = 0$
Gate to source cutoff voltage	$V_{GS(off)}$	0.4	—	1.4	V	$V_{DS} = 10 \text{ V}$, $I_D = 1 \text{ mA}$
Drain to source on state resistance	$R_{DS(on)}$	—	210	270	$\text{m}\Omega$	$I_D = 1.2 \text{ A}$, $V_{GS} = 4.5 \text{ V}$ ^{Note3}
Drain to source on state resistance	$R_{DS(on)}$	—	250	350	$\text{m}\Omega$	$I_D = 1.2 \text{ A}$, $V_{GS} = 2.5 \text{ V}$ ^{Note3}
Forward transfer admittance	$ y_{fs} $	2.8	4.4	—	S	$I_D = 1.2 \text{ A}$, $V_{DS} = 10 \text{ V}$ ^{Note3}
Input capacitance	C_{iss}	—	170	—	pF	$V_{DS} = 10 \text{ V}$
Output capacitance	C_{oss}	—	24	—	pF	$V_{GS} = 0$
Reverse transfer capacitance	C_{rss}	—	11	—	pF	$f = 1 \text{ MHz}$
Turn - on delay time	$t_{d(on)}$	—	10	—	ns	$I_D = 1.2 \text{ A}$
Rise time	t_r	—	33	—	ns	$V_{GS} = 4.5 \text{ V}$
Turn - off delay time	$t_{d(off)}$	—	26	—	ns	$R_L = 8.3 \text{ } \Omega$
Fall time	t_f	—	5	—	ns	$R_g = 4.7 \text{ } \Omega$
Total gate charge	Q_g	—	2	—	nC	$V_{DD} = 10 \text{ V}$
Gate to Source charge	Q_{gs}	—	0.4	—	nC	$V_{GS} = 4.5 \text{ V}$
Gate to drain charge	Q_{gd}	—	0.5	—	nC	$I_D = 2.4 \text{ A}$
Body - drain diode forward voltage	V_{DF}	—	0.8	—	V	$I_F = 2.4 \text{ A}$, $V_{GS} = 0$ ^{Note3}

Notes: 3. Pulse test

Main Characteristics

Maximum Channel Power Dissipation Curve

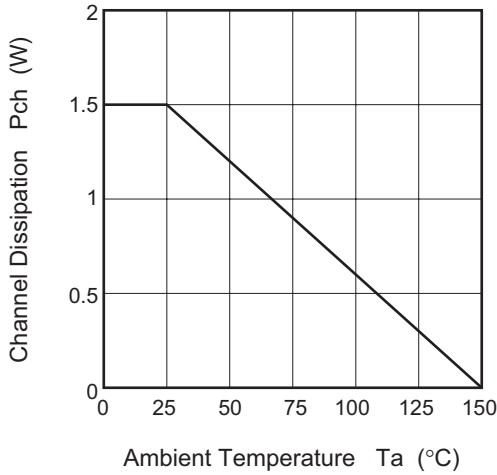

*When using the glass epoxy board (FR-4 40 x 40 x 1 mm)

Maximum Safe Operation Area

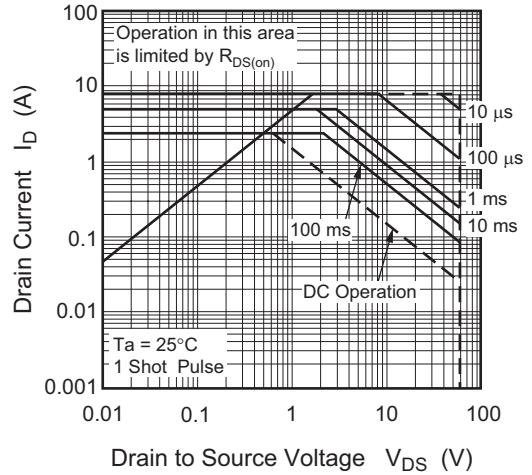

Typical Output Characteristics

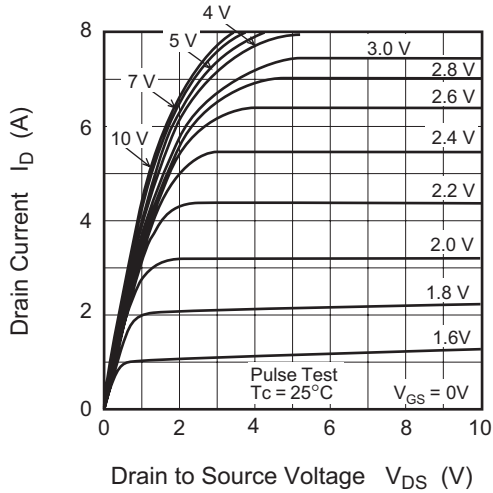

Typical Transfer Characteristics (1)

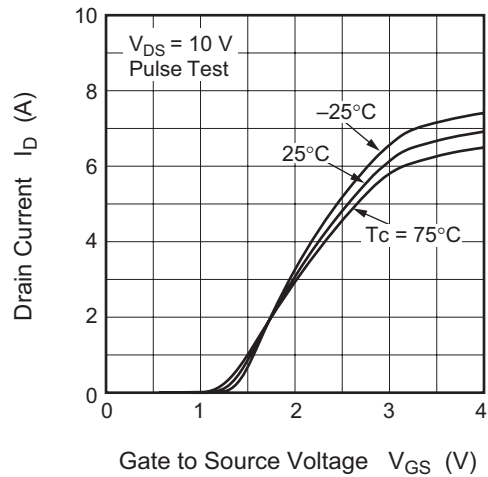

Typical Transfer Characteristics (2)

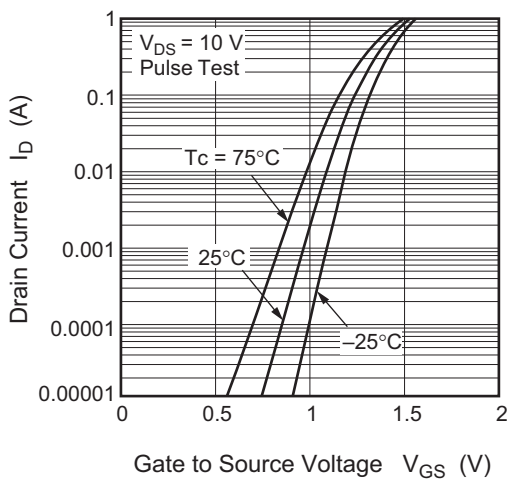

Gate to Source Cutoff Voltage vs. Case Temperature

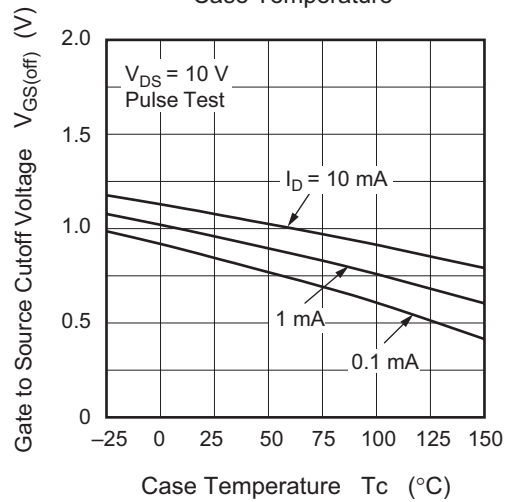

Drain to Source Saturation Voltage vs. Gate to Source Voltage

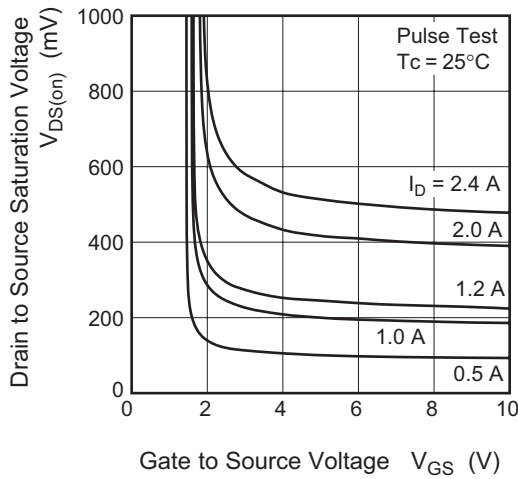

Static Drain to Source on State Resistance vs. Drain Current

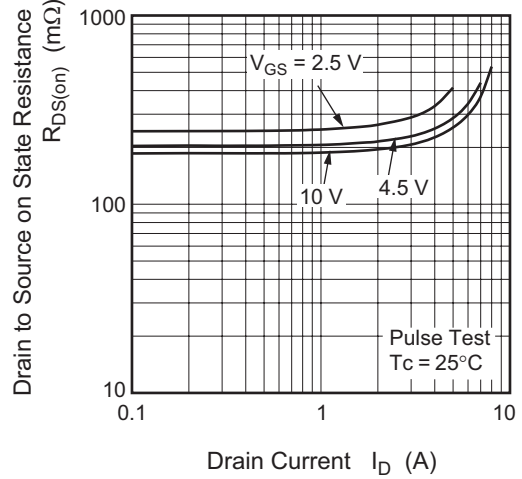

Static Drain to Source on State Resistance vs. Case Temperature (1)

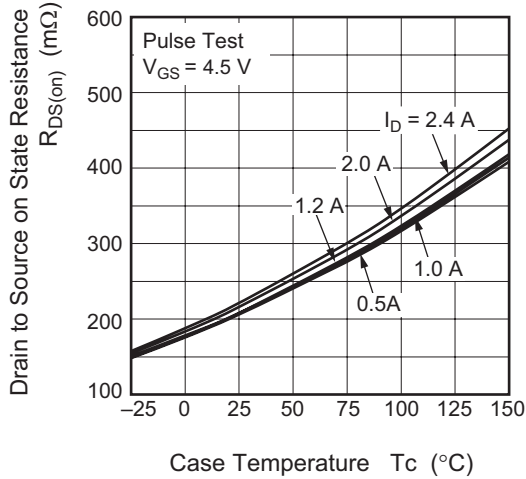

Static Drain to Source on State Resistance vs. Case Temperature (2)

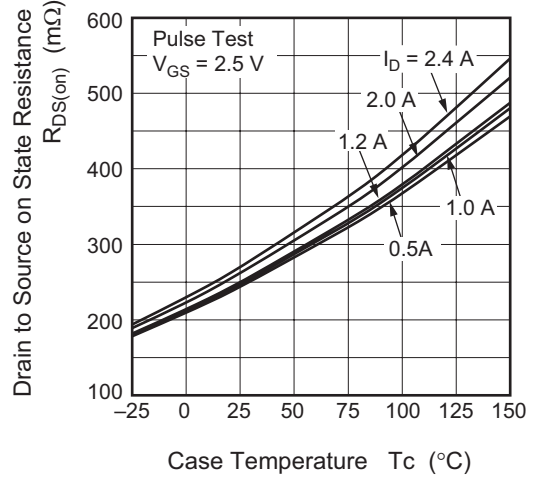

Forward Transfer Admittance vs. Drain Current

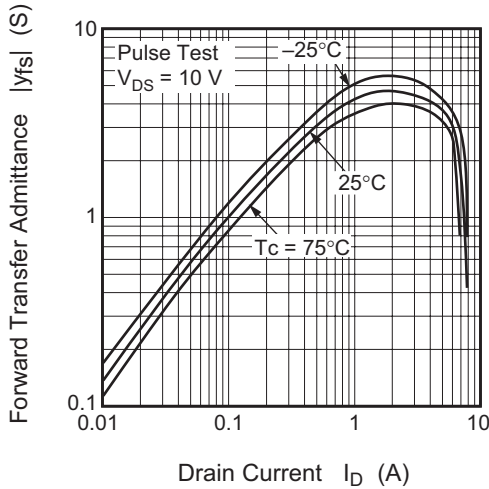

Zero Gate Voltage Drain current vs. Case Temperature

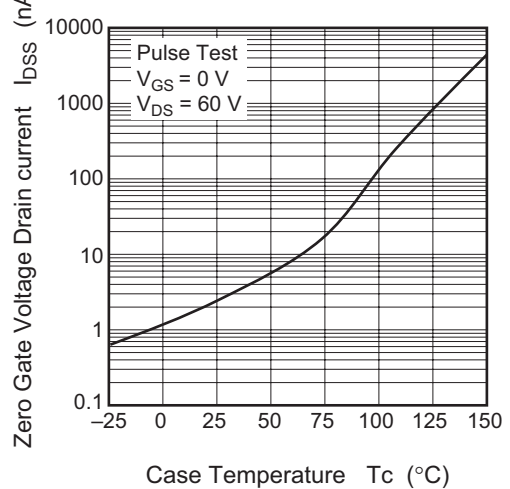

Dynamic Input Characteristics

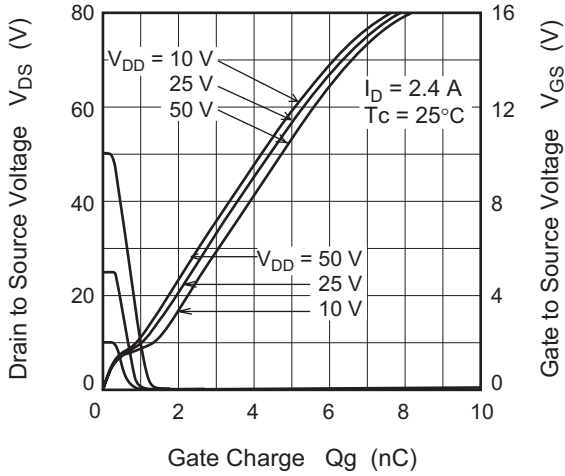

Switching Characteristics

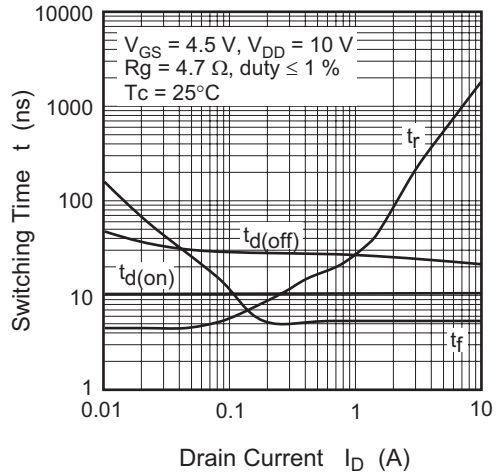

Typical Capacitance vs. Drain to Source Voltage

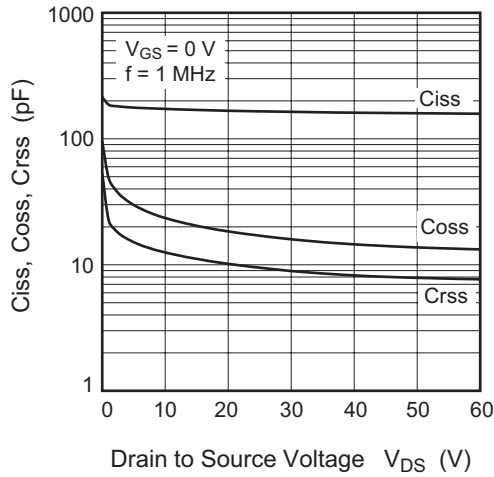

Input Capacitance vs. Gate to Source Voltage

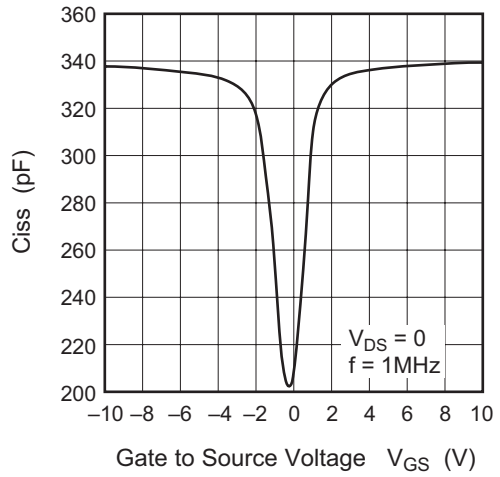

Reverse Drain Current vs. Source to Drain Voltage

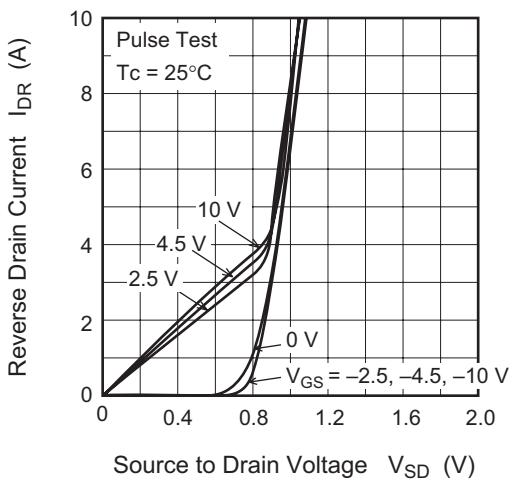

Body-Drain Diode Forward Voltage vs. Case Temperature

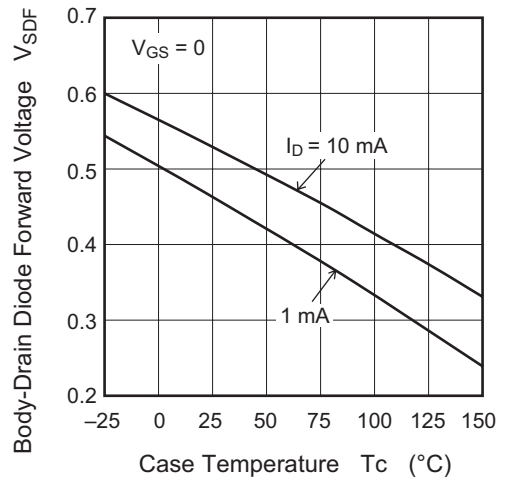

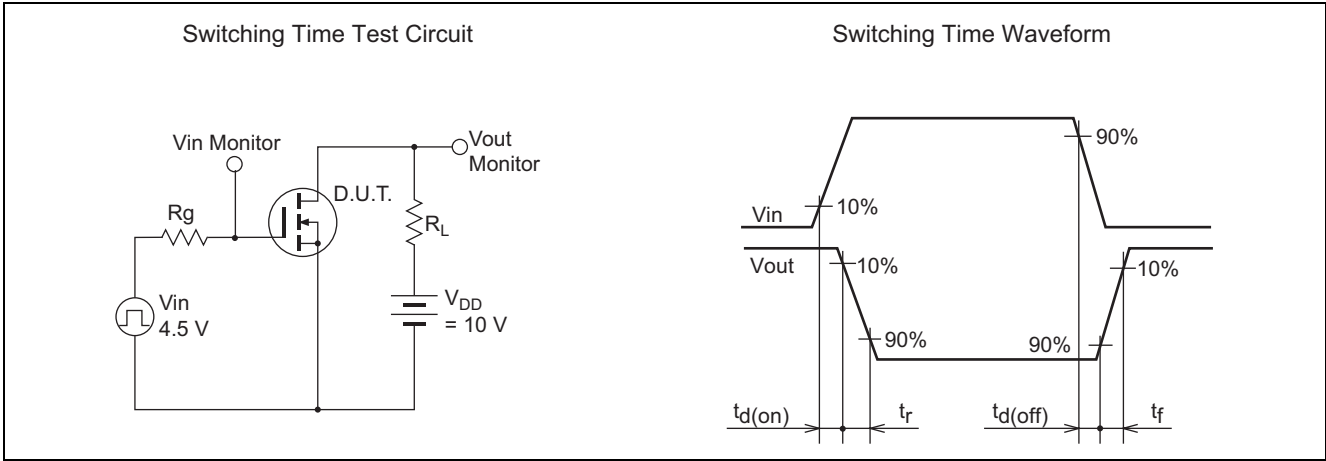

Package Dimensions

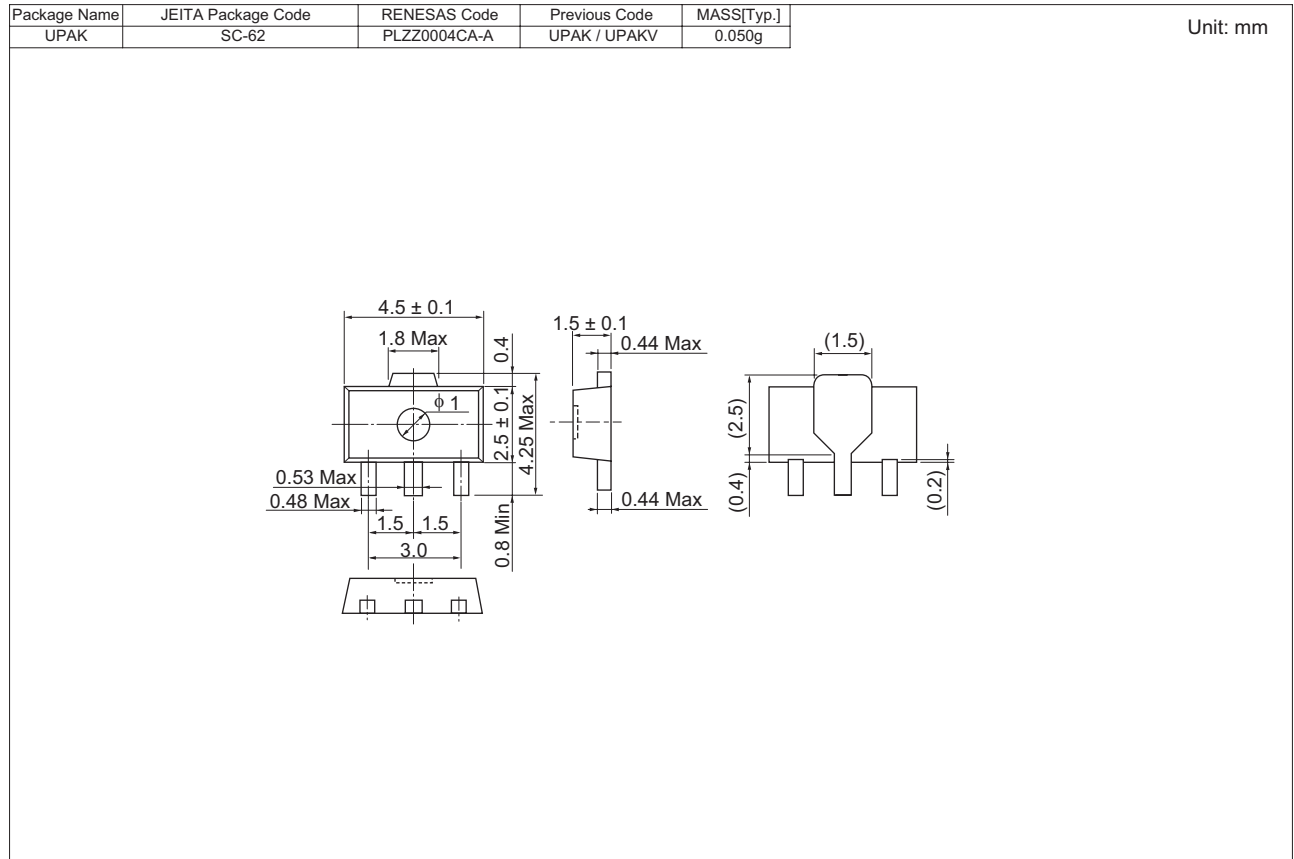

Ordering Information

Part No.	Quantity	Shipping Container
RQK0607AQDQSTL-E	1000 pcs.	ϕ 178 mm reel, 12 mm Emboss taping

Notes:

1. This document is provided for reference purposes only so that Renesas customers may select the appropriate Renesas products for their use. Renesas neither makes warranties or representations with respect to the accuracy or completeness of the information contained in this document nor grants any license to any intellectual property rights or any other rights of Renesas or any third party with respect to the information in this document.
2. Renesas shall have no liability for damages or infringement of any intellectual property or other rights arising out of the use of any information in this document, including, but not limited to, product data, diagrams, charts, programs, algorithms, and application circuit examples.
3. You should not use the products or the technology described in this document for the purpose of military applications such as the development of weapons of mass destruction or for the purpose of any other military use. When exporting the products or technology described herein, you should follow the applicable export control laws and regulations, and procedures required by such laws and regulations.
4. All information included in this document such as product data, diagrams, charts, programs, algorithms, and application circuit examples, is current as of the date this document is issued. Such information, however, is subject to change without any prior notice. Before purchasing or using any Renesas products listed in this document, please confirm the latest product information with a Renesas sales office. Also, please pay regular and careful attention to additional and different information to be disclosed by Renesas such as that disclosed through our website. (<http://www.renesas.com>)
5. Renesas has used reasonable care in compiling the information included in this document, but Renesas assumes no liability whatsoever for any damages incurred as a result of errors or omissions in the information included in this document.
6. When using or otherwise relying on the information in this document, you should evaluate the information in light of the total system before deciding about the applicability of such information to the intended application. Renesas makes no representations, warranties or guarantees regarding the suitability of its products for any particular application and specifically disclaims any liability arising out of the application and use of the information in this document or Renesas products.
7. With the exception of products specified by Renesas as suitable for automobile applications, Renesas products are not designed, manufactured or tested for applications or otherwise in systems the failure or malfunction of which may cause a direct threat to human life or create a risk of human injury or which require especially high quality and reliability such as safety systems, or equipment or systems for transportation and traffic, healthcare, combustion control, aerospace and aeronautics, nuclear power, or undersea communication transmission. If you are considering the use of our products for such purposes, please contact a Renesas sales office beforehand. Renesas shall have no liability for damages arising out of the uses set forth above.
8. Notwithstanding the preceding paragraph, you should not use Renesas products for the purposes listed below:
 - (1) artificial life support devices or systems
 - (2) surgical implantations
 - (3) healthcare intervention (e.g., excision, administration of medication, etc.)
 - (4) any other purposes that pose a direct threat to human lifeRenesas shall have no liability for damages arising out of the uses set forth in the above and purchasers who elect to use Renesas products in any of the foregoing applications shall indemnify and hold harmless Renesas Technology Corp., its affiliated companies and their officers, directors, and employees against any and all damages arising out of such applications.
9. You should use the products described herein within the range specified by Renesas, especially with respect to the maximum rating, operating supply voltage range, movement power voltage range, heat radiation characteristics, installation and other product characteristics. Renesas shall have no liability for malfunctions or damages arising out of the use of Renesas products beyond such specified ranges.
10. Although Renesas endeavors to improve the quality and reliability of its products, IC products have specific characteristics such as the occurrence of failure at a certain rate and malfunctions under certain use conditions. Please be sure to implement safety measures to guard against the possibility of physical injury, and injury or damage caused by fire in the event of the failure of a Renesas product, such as safety design for hardware and software including but not limited to redundancy, fire control and malfunction prevention, appropriate treatment for aging degradation or any other applicable measures. Among others, since the evaluation of microcomputer software alone is very difficult, please evaluate the safety of the final products or system manufactured by you.
11. In case Renesas products listed in this document are detached from the products to which the Renesas products are attached or affixed, the risk of accident such as swallowing by infants and small children is very high. You should implement safety measures so that Renesas products may not be easily detached from your products. Renesas shall have no liability for damages arising out of such detachment.
12. This document may not be reproduced or duplicated, in any form, in whole or in part, without prior written approval from Renesas.
13. Please contact a Renesas sales office if you have any questions regarding the information contained in this document, Renesas semiconductor products, or if you have any other inquiries.



RENESAS SALES OFFICES

<http://www.renesas.com>

Refer to "<http://www.renesas.com/en/network>" for the latest and detailed information.

Renesas Technology America, Inc.
450 Holger Way, San Jose, CA 95134-1368, U.S.A
Tel: <1> (408) 382-7500, Fax: <1> (408) 382-7501

Renesas Technology Europe Limited
Dukes Meadow, Millboard Road, Bourne End, Buckinghamshire, SL8 5FH, U.K.
Tel: <44> (1628) 585-100, Fax: <44> (1628) 585-900

Renesas Technology (Shanghai) Co., Ltd.
Unit 204, 205, AZIACenter, No.1233 Lujiazui Ring Rd, Pudong District, Shanghai, China 200120
Tel: <86> (21) 5877-1818, Fax: <86> (21) 6887-7858/7898

Renesas Technology Hong Kong Ltd.
7th Floor, North Tower, World Finance Centre, Harbour City, Canton Road, Tsimshatsui, Kowloon, Hong Kong
Tel: <852> 2265-6688, Fax: <852> 2377-3473

Renesas Technology Taiwan Co., Ltd.
10th Floor, No.99, Fushing North Road, Taipei, Taiwan
Tel: <886> (2) 2715-2888, Fax: <886> (2) 3518-3399

Renesas Technology Singapore Pte. Ltd.
1 Harbour Front Avenue, #06-10, Keppel Bay Tower, Singapore 098632
Tel: <65> 6213-0200, Fax: <65> 6278-8001

Renesas Technology Korea Co., Ltd.
Kukje Center Bldg. 18th Fl., 191, 2-ka, Hangang-ro, Yongsan-ku, Seoul 140-702, Korea
Tel: <82> (2) 796-3115, Fax: <82> (2) 796-2145

Renesas Technology Malaysia Sdn. Bhd
Unit 906, Block B, Menara Amcorp, Amcorp Trade Centre, No.18, Jln Persiaran Barat, 46050 Petaling Jaya, Selangor Darul Ehsan, Malaysia
Tel: <603> 7955-9390, Fax: <603> 7955-9510