

ALM-32120

0.7GHz – 1.0GHz

2 Watt High Linearity Amplifier



Data Sheet

Description

Avago Technologies' ALM-32120 is a high linearity 2 Watt PA with good OIP3 performance and exceptionally good PAE at 1dB gain compression point, achieved through the use of Avago Technologies' proprietary 0.25um GaAs Enhancement-mode pHEMT process.

All matching components are fully integrated within the module and the 50Ω RF input and output pins are already internally AC-coupled. This makes the ALM-32120 extremely easy to use as the only external parts are DC supply bypass capacitors.

The adjustable temperature-compensated internal bias circuit allows the device to be operated at either class A or class AB operation. The ALM-32120 is housed inside a miniature 7.0 x 10.0 x 1.1 mm³ 20-lead multiple-chips-on-board (MCOB) module package.

Component Image

7.0 x 10.0 x 1.1mm³ 20-Lead MCOB Package



Top View

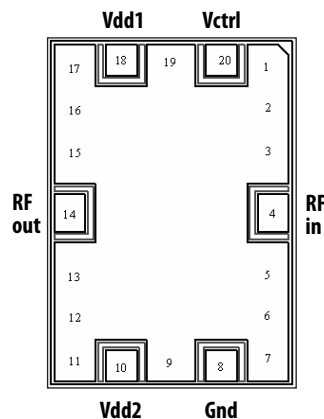

Bottom View

Note:

Package marking provides orientation and identification

"32120" = Device Part Number

"WWYY" = Work week and year of manufacture

"XXXX" = Last 4 digit of lot number

Features

- Fully matched, input and output
- High linearity and P1dB
- Unconditionally stable across load condition
- Built-in adjustable temperature compensated internal bias circuitry
- GaAs E-pHEMT Technology^[1]
- 5V supply
- Excellent uniformity in product specifications
- Tape-and-Reel packaging option available
- MSL-3 and Lead-free
- High MTTF for base station application

Specifications

900MHz; 5V, 800mA (typical)

- 14.3 dB Gain
- 52.0 dBm Output IP3
- 34.4 dBm Output Power at 1dB Gain Compression
- 50.3% PAE at P1dB
- 2.5dB Noise Figure

Applications

- Class A driver amplifier for GSM / W-CDMA / WiMAX base stations.
- General purpose gain block.

Note:

1. Enhancement mode technology employs positive gate voltage, thereby eliminating the need of negative gate voltage associated with conventional depletion mode devices.



Attention: Observe precautions for handling electrostatic sensitive devices.

ESD Machine Model = 150 V

ESD Human Body Model = 200 V

Refer to Avago Application Note A004R:

Electrostatic Discharge, Damage and Control.

Absolute Maximum Rating^[2] T_A=25°C

Symbol	Parameter	Units	Absolute Max.
V _{dd,max}	Device Voltage, RF output to ground	V	5.5
I _{ds,max}	Device Drain Current	mA	1500
V _{ctrl,max}	Control Voltage	V	5.5
P _{in,max}	CW RF Input Power	dBm	28
P _{diss}	Total Power Dissipation ^[4]	W	8.25
T _{j,max}	Junction Temperature	°C	150
T _{STG}	Storage Temperature	°C	-65 to 150

Thermal Resistance^[3] $\theta_{jc} = 12^{\circ}\text{C}/\text{W}$
(V_{dd}=5, I_{ds}=800mA, T_c=85°C)

Notes:

- Operation of this device in excess of any of these limits may cause permanent damage.
- Thermal resistance measured using Infra-Red measurement technique.
- This is limited by maximum V_{dd} and I_{ds}. Derate 83.3mW/°C for T_c > 51.0°C.

Product Consistency Distribution Charts^[5]

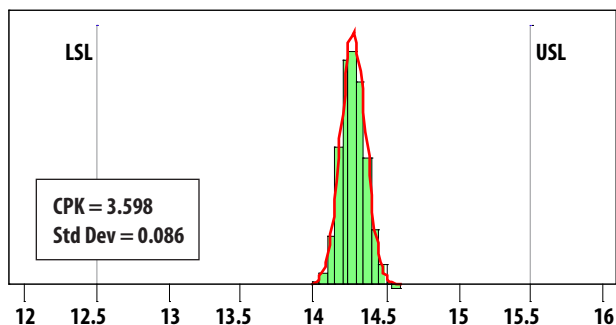
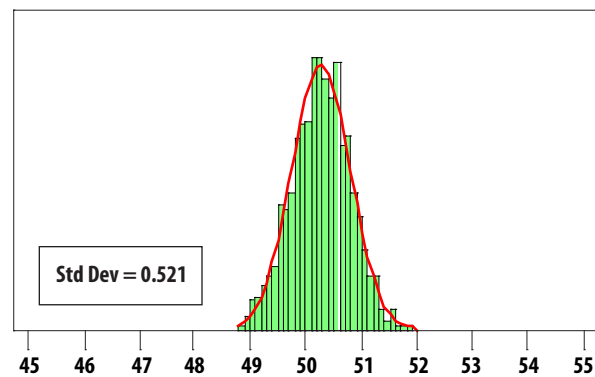
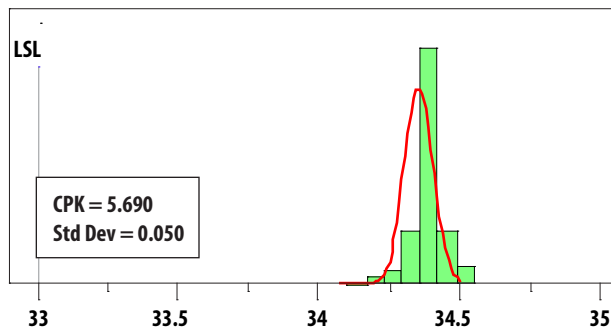
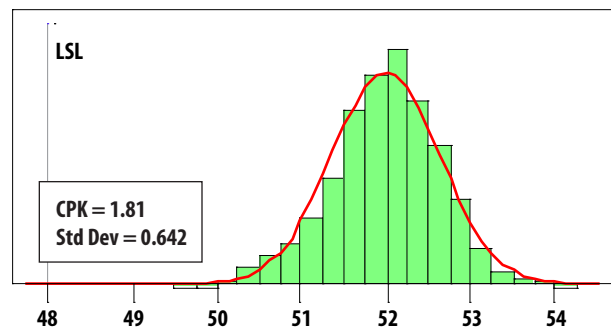
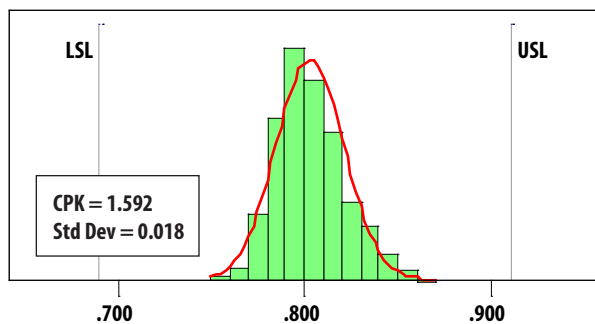

Note:

- Distribution data sample size is 500 samples taken from 3 different wafer lots. T_A = 25°C, V_{dd} = 5V, V_{ctrl} = 5V, RF performance at 900MHz unless otherwise specified. Future wafers allocated to this product may have nominal values anywhere between the upper and lower limits.
- Measurements are made on a production test board. Input trace losses have not been de-embedded from actual measurements.

Electrical Specifications [7]

$T_A = 25\text{ }^{\circ}\text{C}$, $V_{dd} = 5\text{V}$, $V_{ctrl} = 5\text{V}$, RF performance at 900MHz, measured on demo board (see Figure 7) unless otherwise specified.

Symbol	Parameter and Test Condition	Units	Min.	Typ.	Max.
I_{ds}	Quiescent current	mA	690	800	910
I_{ctrl}	V_{ctrl} current	mA	-	18	-
Gain	Gain	dB	12.5	14.3	15.5
OIP3 [8]	Output Third Order Intercept Point	dBm	48.0	52.0	-
OP1dB	Output Power at 1dB Gain Compression	dBm	33.0	34.4	-
PAE	Power Added Efficiency	%	-	50.3	-
NF	Noise Figure	dB	-	2.5	-
S11	Input Return Loss, 50 Ω source	dB	-	-26.0	-
S22	Output Return Loss, 50 Ω load	dB	-	-10.0	-
S12	Reverse Isolation	dB	-	-22.0	-

Notes:

7. Measurements at 900MHz obtained using demo board described in Figure 6 and 7.

8. OIP3 test condition: $F_{RF1} - F_{RF2} = 10\text{MHz}$ with input power of -5dBm per tone measured at worst side band

9. Use proper biasing, heat sink and de-rating to ensure maximum channel temperature is not exceeded. See absolute maximum ratings and application note (if applicable) for more details.

S-Parameter [1] (Vdd = 5V, Vctrl = 5V, T = 25°C, matched 50Ω)

Freq (GHz)	S11 (dB)	S11 (ang)	S21 (dB)	S21 (ang)	S12 (dB)	S12 (ang)	S22 (dB)	S22 (ang)
0.1	-0.40	155.04	-77.61	-21.22	-77.34	112.66	-0.24	176.51
0.2	-0.61	128.86	-59.66	-32.35	-82.50	-92.20	-0.36	145.53
0.3	-0.92	97.96	-29.60	-114.42	-75.71	-122.91	-0.60	115.17
0.4	-2.33	54.49	-5.72	151.06	-55.06	115.01	-2.06	80.35
0.5	-5.61	6.14	9.54	19.74	-35.62	-13.98	-3.83	48.30
0.6	-10.71	-56.31	14.99	-110.41	-27.21	-138.86	-5.87	1.87
0.7	-15.32	-125.97	15.40	151.35	-24.29	127.16	-8.63	-71.71
0.8	-19.59	179.34	14.97	70.70	-22.56	49.82	-10.65	-144.17
0.9	-22.91	-168.95	14.11	0.02	-21.54	-18.15	-10.54	161.96
1.0	-19.20	-138.26	13.11	-66.17	-20.88	-82.10	-9.92	117.93
1.1	-10.76	-147.19	11.86	-132.62	-20.65	-146.68	-11.25	49.42
1.2	-6.24	-171.20	9.61	158.70	-21.53	146.23	-11.49	-63.48
1.3	-3.12	160.42	6.06	92.52	-23.82	81.43	-8.98	-171.96
1.4	-1.78	132.14	2.08	27.78	-26.58	17.80	-10.19	139.32
1.5	-1.21	106.59	-4.64	-52.99	-31.91	-62.08	-8.82	142.57
1.6	-0.89	86.87	-14.37	-115.03	-40.29	-124.04	-3.18	133.86
1.7	-0.74	68.55	-25.37	-153.22	-49.67	-163.90	-1.27	99.55
1.8	-0.69	51.72	-35.97	-176.83	-58.04	168.27	-0.92	75.54
1.9	-0.67	35.89	-47.17	170.36	-65.35	142.70	-0.79	56.16
2.0	-0.66	20.71	-58.28	-169.01	-71.72	115.56	-0.74	39.08
2.1	-0.65	5.96	-62.77	-133.99	-76.55	89.58	-0.71	23.31
2.2	-0.65	-8.48	-60.93	-136.36	-78.43	69.57	-0.69	8.36
2.3	-0.64	-22.68	-59.21	177.52	-78.14	59.36	-0.68	-6.01
2.4	-0.64	-36.69	-58.28	120.54	-76.51	44.97	-0.67	-19.98
2.5	-0.64	-50.51	-57.95	74.70	-74.86	27.97	-0.66	-33.68
2.6	-0.64	-64.16	-57.86	44.60	-74.27	11.86	-0.66	-47.17
2.7	-0.64	-77.63	-57.75	23.55	-73.46	-0.91	-0.65	-60.49
2.8	-0.64	-90.92	-57.64	6.42	-73.24	-13.81	-0.65	-73.64
2.9	-0.63	-104.02	-57.56	-8.59	-72.79	-25.87	-0.65	-86.63
3.0	-0.63	-116.91	-57.51	-22.79	-72.00	-36.46	-0.64	-99.47
3.1	-0.63	-129.58	-57.56	-36.61	-71.61	-47.24	-0.64	-112.16
3.2	-0.63	-142.02	-57.57	-49.84	-70.96	-58.09	-0.64	-124.68
3.3	-0.62	-154.24	-57.54	-62.66	-70.44	-68.64	-0.63	-137.02
3.4	-0.62	-166.24	-57.58	-74.98	-70.07	-80.37	-0.62	-149.18
3.5	-0.62	-178.02	-57.62	-87.16	-69.57	-91.12	-0.62	-161.17
3.6	-0.62	170.40	-57.64	-99.31	-69.05	-102.57	-0.61	-172.96
3.7	-0.63	159.01	-57.61	-111.28	-68.53	-113.51	-0.61	175.46
3.8	-0.63	147.77	-57.60	-122.51	-68.10	-124.48	-0.60	164.06
3.9	-0.64	135.31	-57.42	-135.37	-67.84	-135.22	-0.60	151.49
4.0	-0.66	124.34	-57.18	-147.19	-67.26	-143.42	-0.59	140.52
4.1	-0.68	113.45	-57.00	-159.04	-66.59	-153.87	-0.59	129.72
4.2	-0.70	102.58	-56.77	-170.85	-66.10	-165.62	-0.59	119.10
4.3	-0.73	91.73	-56.53	177.43	-65.62	-175.25	-0.59	108.63
4.4	-0.76	80.85	-56.22	165.95	-65.12	175.99	-0.59	98.29
4.5	-0.79	69.86	-55.85	154.53	-64.56	166.68	-0.59	88.06
4.6	-0.82	58.72	-55.39	143.15	-63.67	158.11	-0.59	77.96
4.7	-0.86	47.35	-54.81	131.86	-62.75	148.26	-0.60	67.93
4.8	-0.91	35.74	-54.13	120.42	-61.67	138.82	-0.60	57.96
4.9	-0.97	23.78	-53.28	107.88	-60.31	126.76	-0.61	48.03
5.0	-1.03	11.43	-52.37	94.74	-59.23	113.12	-0.62	38.09
5.1	-1.10	-1.39	-51.46	81.45	-58.21	99.98	-0.63	28.15
5.2	-1.18	-14.77	-50.40	67.58	-56.97	85.85	-0.64	18.16
5.3	-1.28	-28.75	-49.21	53.20	-55.82	71.44	-0.66	8.13
5.4	-1.38	-43.41	-47.89	38.07	-54.53	57.04	-0.68	-1.98
5.5	-1.50	-58.76	-46.40	22.01	-53.00	41.97	-0.70	-12.20
5.6	-1.63	-74.82	-44.73	4.98	-51.29	25.49	-0.72	-22.56
5.7	-1.78	-91.48	-42.78	-13.26	-49.27	7.79	-0.75	-33.07
5.8	-1.93	-108.60	-40.51	-34.28	-46.84	-14.16	-0.79	-43.76
5.9	-2.05	-126.13	-38.10	-59.04	-44.48	-40.96	-0.83	-54.65
6.0	-2.17	-143.89	-35.74	-87.52	-42.34	-70.74	-0.89	-65.73

Notes:

1. S-parameter is measured with reference plane at SMA end launch using demo board shown in Figure 7.
2. Demo board 50Ω transmission line is CPWG with W = 21.7 mils, G = 19.2 mils, L = 615.5 mils, 10 mils Rogers RO4350, 0.5oz Cu.
3. Demo board SMA end launch is Johnson 142-0701-851.

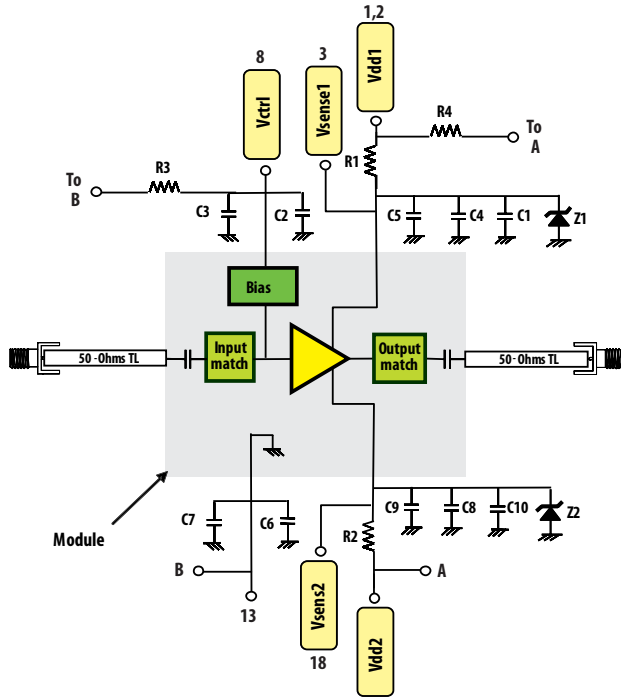

Circuit Symbol	Size	Value	Description
C1, C10	0805	2.2uF	Ceramic Chip Capacitor
C2, C4, C9	0402	0.1 uF	Ceramic Chip Capacitor
C3, C5, C8	0402	10nF	Ceramic Chip Capacitor
C6, C7	0402	Not Used	N/A
R1, R2	1206	0 Ohm	Chip Resistor
R3	0402	Not Used	N/A
R4	0805	0 Ohm	Chip Resistor
Z1, Z2	0805	Not Used	Zener Diode 5.6V (Optional)

Note:
To supply Vdd1 and Vdd2 individually, remove R4 and supply Vdd1 from pin 1,2 and Vdd2 from pin 19,20

Figure 6. Demo board application schematics and components table

Demo board layout

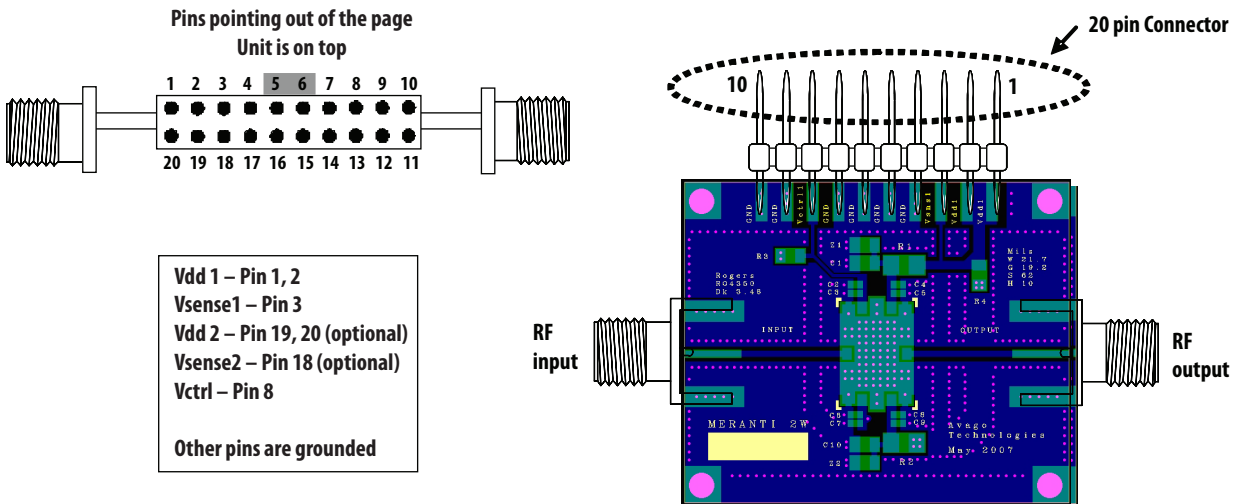

Figure 7. Demo board layout diagram

1. Recommended PCB material is 10 mils Rogers RO4350, with FR4 backing for mechanical strength.
2. Suggested component values may vary according to layout and PCB material.

ALM-32120 Typical Over-Temperature Performance

Vdd = 5V, Vctrl = 5V, Input Signal = CW unless stated otherwise.

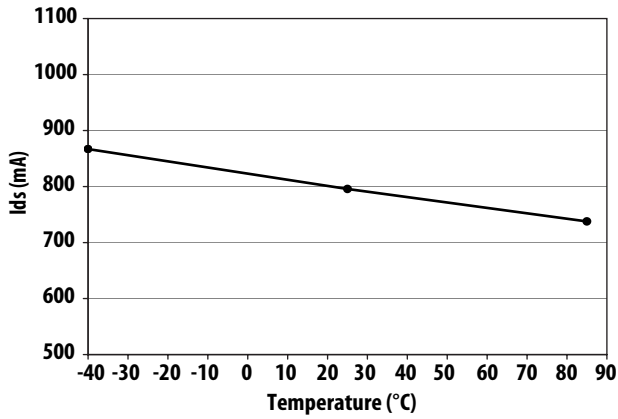

Figure 8. Over temperature Ids

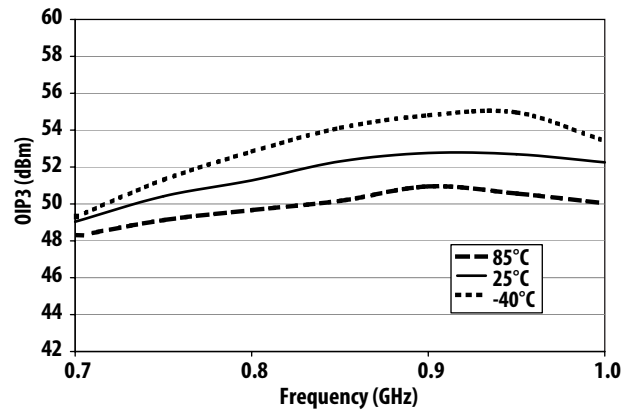

Figure 9. Over temperature OIP3 vs Frequency

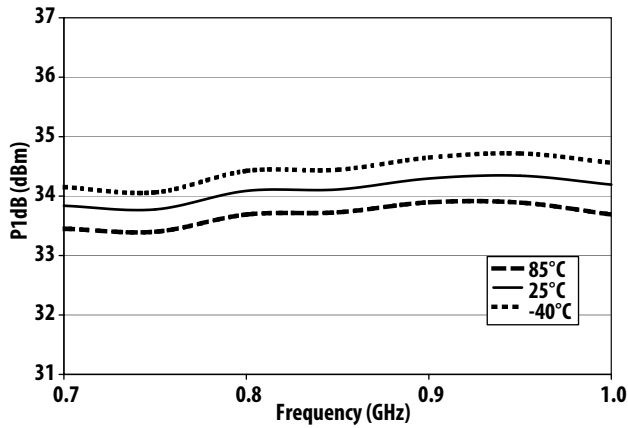

Figure 10. Over temperature P1dB vs Frequency

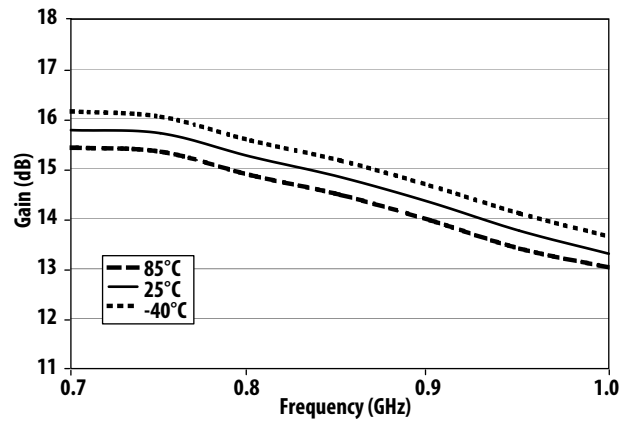

Figure 11. Over temperature Gain vs Frequency

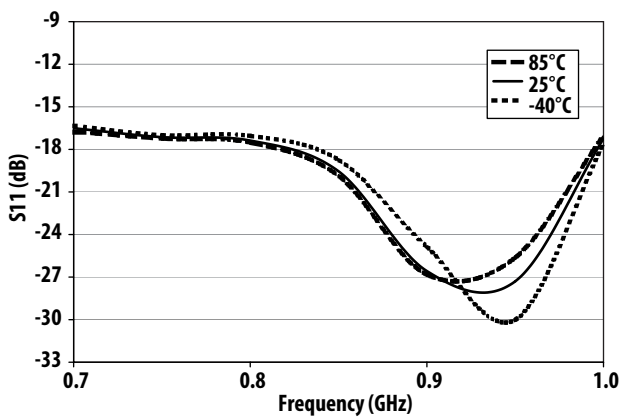

Figure 12. Over temperature S11 vs Frequency

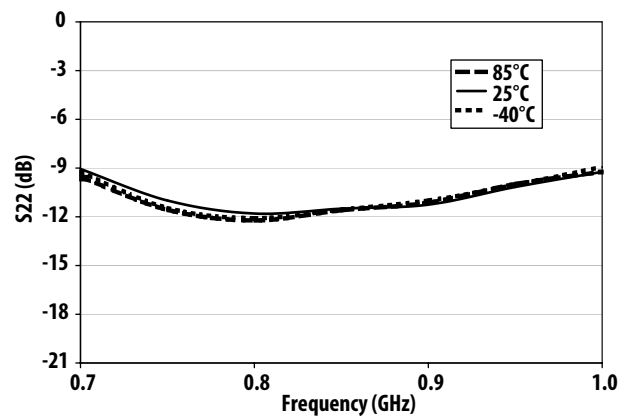

Figure 13. Over temperature S22 vs Frequency

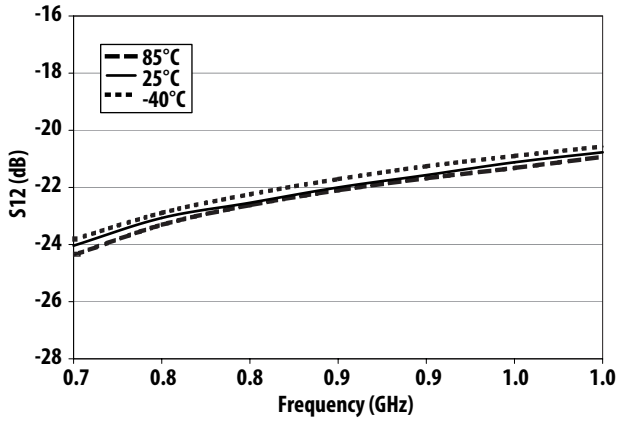

Figure 14. Over temperature S12 vs Frequency

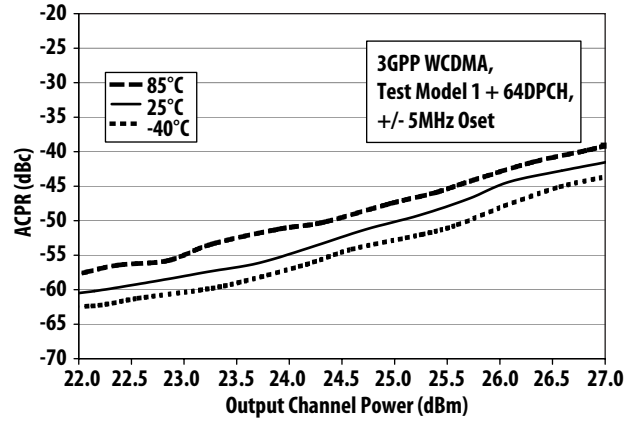

Figure 15. Over temperature WCDMA ACPR vs Channel Power @ 900MHz

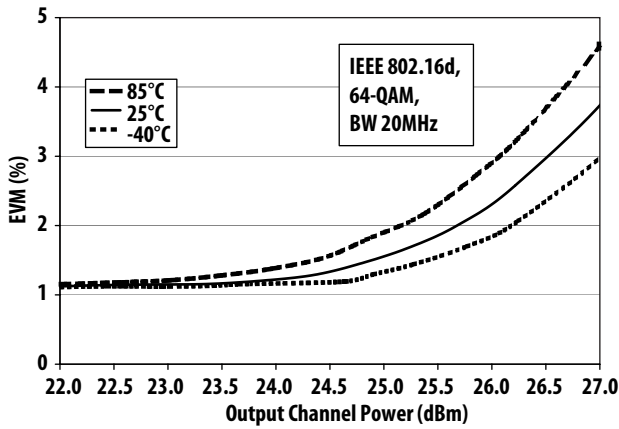

Figure 16. Over temperature WiMAX EVM vs Output Power @ 700MHz

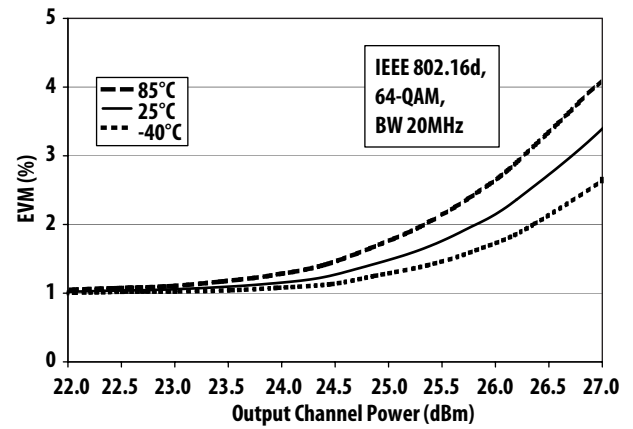
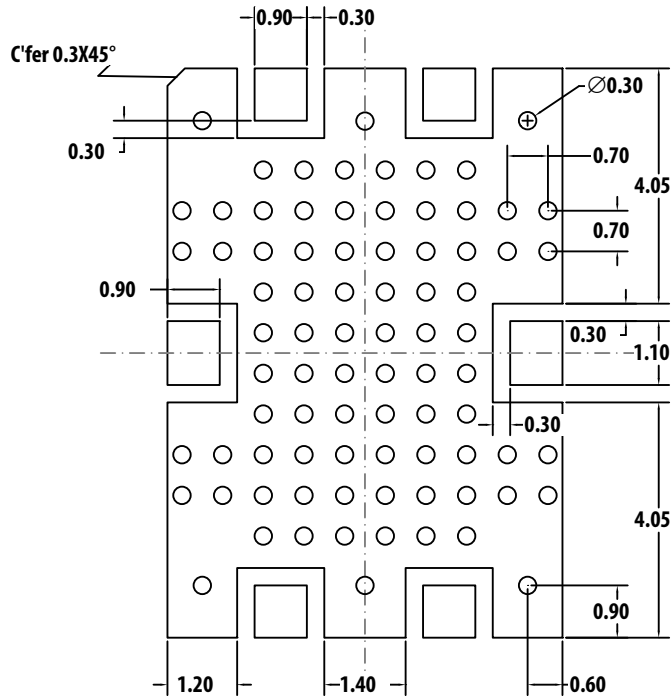
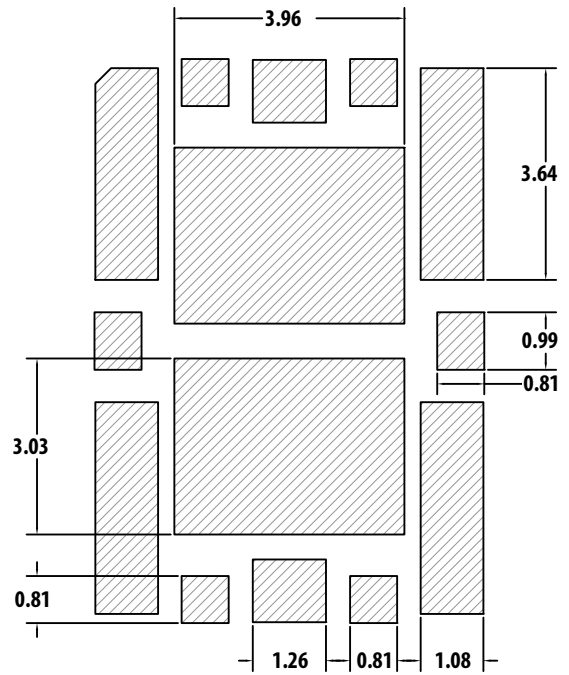

Figure 17. Over temperature WiMAX EVM vs Output Power @ 800MHz

PCB Layout and Stencil Design



PCB Land Pattern (Top View)



Stencil Outline

Note: All dimensions are in millimeters.

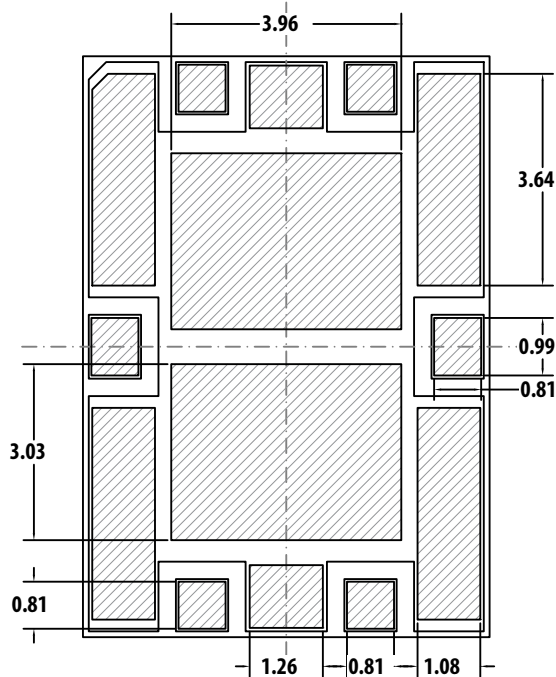

Combined PCB and stencil layout Land Pattern (Top View)

Part Number Ordering Information

Part Number	No. of Devices	Container
ALM-32120-TR1G	1000	13" Reel
ALM-32120-TR2G	3000	13" Reel
ALM-32120-BLKG	100	antistatic bag

Product Family

Output Power	Frequency Band		
	700MHz-1GHz	1.7-2.7GHz	3.3-3.9GHz
0.5W	MGA-30116	MGA-30216	MGA-30316
1W	ALM-31122	ALM-31222	ALM-31322
2W	ALM-32120	ALM-32220	ALM-32320

Device Orientation

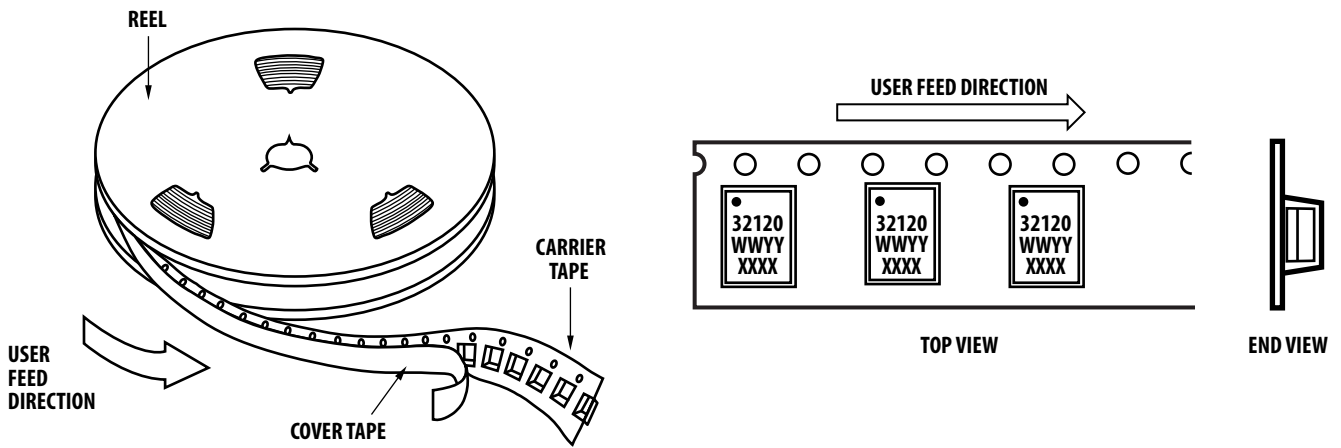

Tape Dimensions

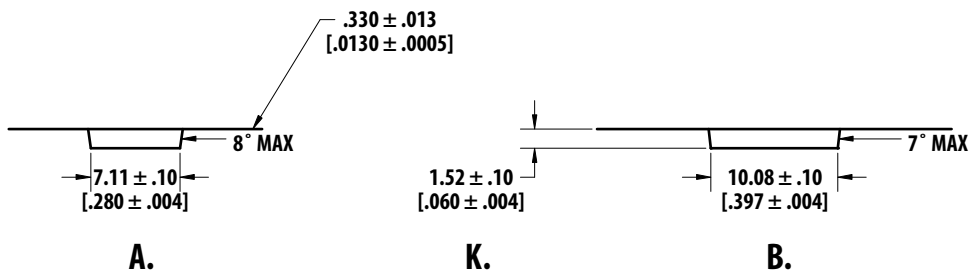
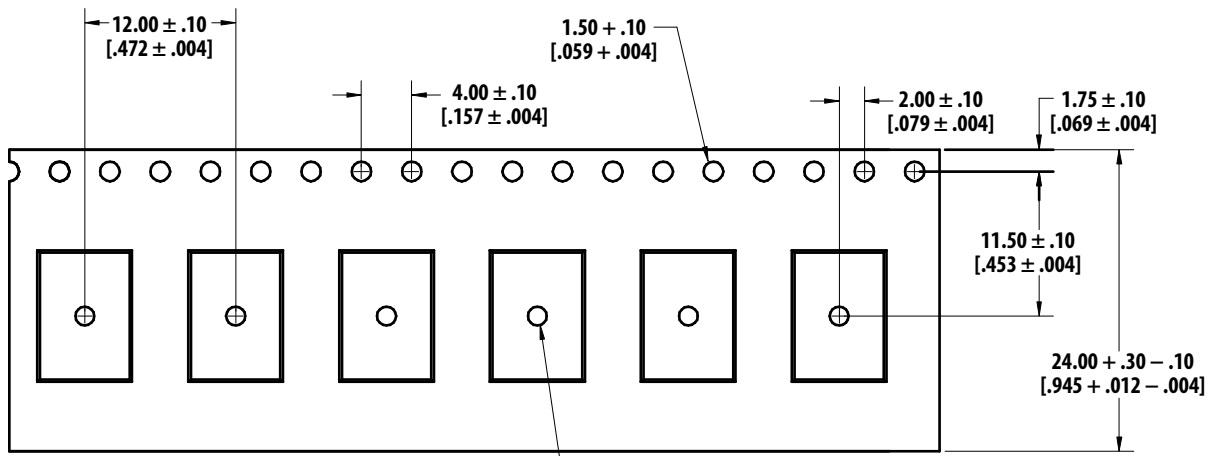

MM
[INCH]

Reel Dimensions - 13" Reel

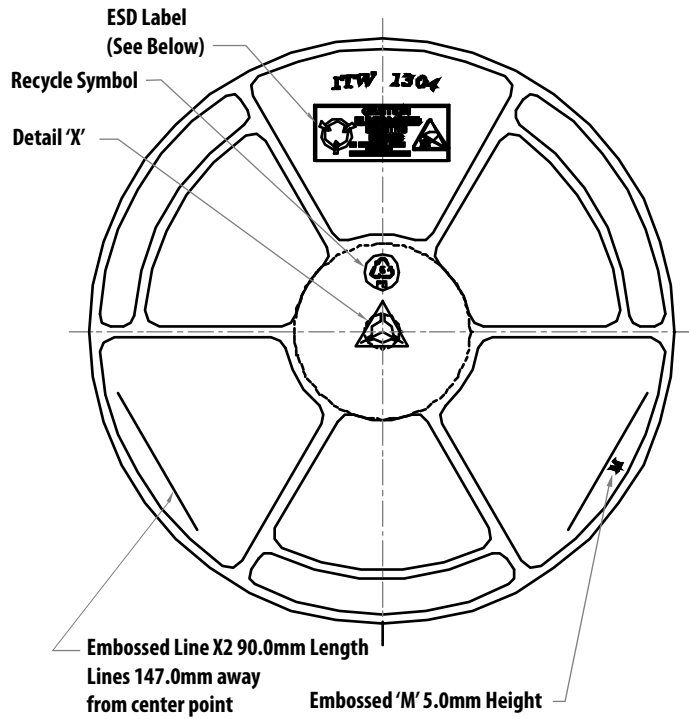

FRONT VIEW

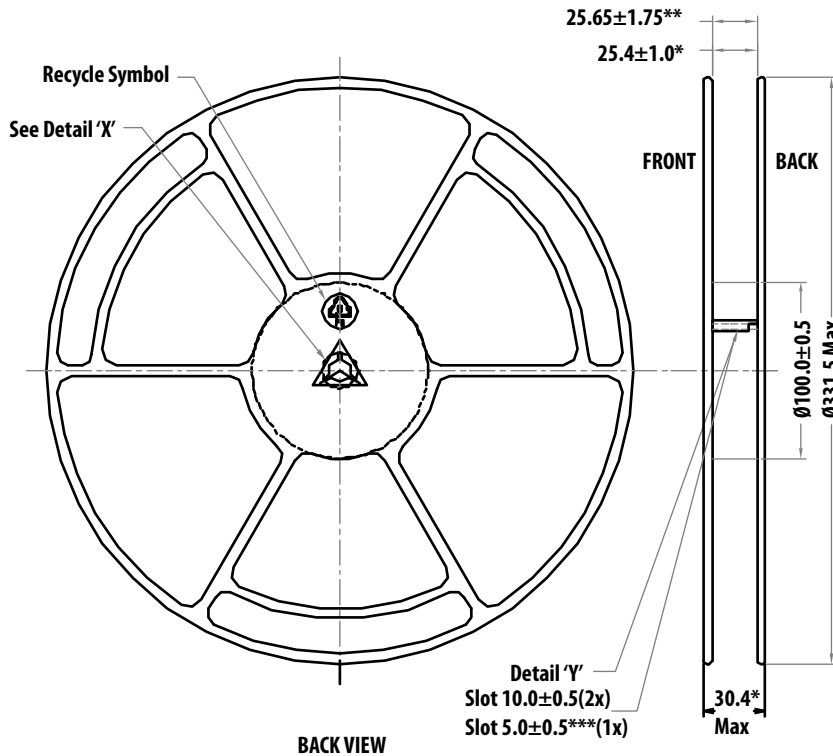

BACK VIEW

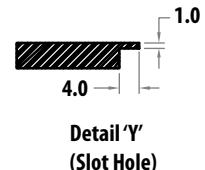
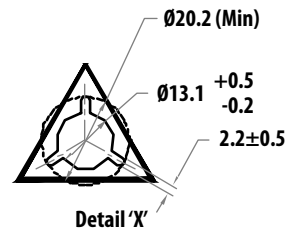

For product information and a complete list of distributors, please go to our web site: www.avagotech.com

Avago, Avago Technologies, and the A logo are trademarks of Avago Technologies in the United States and other countries. Data subject to change. Copyright © 2005-2008 Avago Technologies. All rights reserved. AV02-1349EN - August 26, 2008

