



STS11NF30L

N-channel 30V - 0.0085Ω - 11A SO-8
Low gate charge STripFET™ II Power MOSFET

General features

Type	V _{DSS}	R _{DS(on)}	I _D
STS11NF30L	30V	<0.009Ω	11A

- Optimal R_{DS(on)} x Q_g trade-off
- Conduction losses reduced

Description

This Power MOSFET is the latest development of STMicroelectronics unique "Single Feature Size™" strip-based process. The resulting transistor shows extremely high packing density for low on-resistance, rugged avalanche characteristics and less critical alignment steps therefore a remarkable manufacturing reproducibility.

Applications

- Switching application

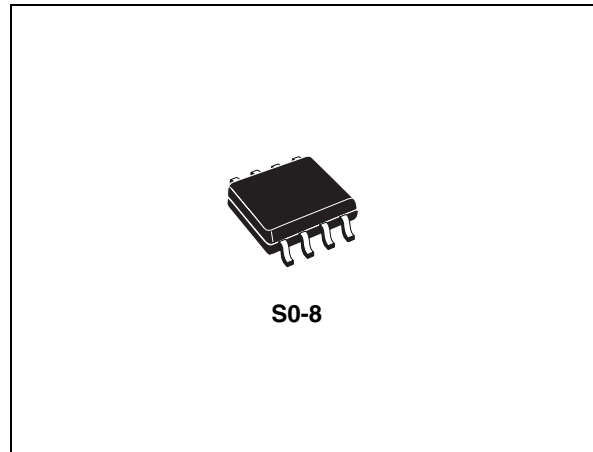

Internal schematic diagram

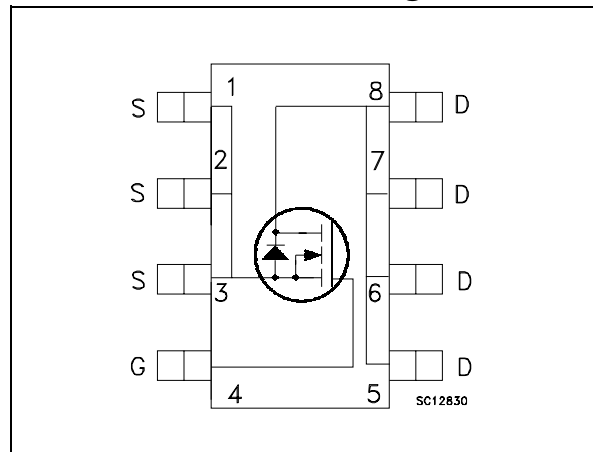

Order codes

Part number	Marking	Package	Packaging
STS11NF30L	11F30L-	SO-8	Tape & reel

Contents

1	Electrical ratings	3
2	Electrical characteristics	4
	2.1 Electrical characteristics (curves)	6
3	Test circuit	8
4	Package mechanical data	9
5	Revision history	11

1 Electrical ratings

Table 1. Absolute maximum ratings

Symbol	Parameter	Value	Unit
V_{DS}	Drain-source voltage ($V_{GS} = 0$)	30	V
V_{GS}	Gate-source voltage	± 18	V
$I_D^{(1)}$	Drain current (continuous) at $T_C = 25^\circ\text{C}$	11	A
I_D	Drain current (continuous) at $T_C = 100^\circ\text{C}$	7	A
$I_{DM}^{(2)}$	Drain current (pulsed)	44	A
P_{TOT}	Total dissipation at $T_C = 25^\circ\text{C}$	2.5	W
	Derating factor	0.02	W/°C
$dv/dt^{(3)}$	Peak diode recovery voltage slope	5.5	V/ns
T_J	Operating junction temperature	-55 to 150	°C
T_{stg}	Storage temperature	150	

1. Current limited by the package
2. Pulse width limited by safe operating area
3. $I_{SD} \leq 1\text{A}$, $di/dt \leq 370\text{A}/\mu\text{s}$, $V_{DD} \leq V_{(BR)DSS}$, $T_J \leq T_{JMAX}$

Table 2. Thermal data

R_{thj-a}	Thermal resistance junction-ambient Max ⁽¹⁾	50	°C/W
T_I	Maximum lead temperature for soldering purpose	150	°C

1. When Mounted on 1 inch² FR-4 board, 2 oz of Cu and t [10 sec

2 Electrical characteristics

($T_{CASE}=25^{\circ}C$ unless otherwise specified)

Table 3. On/off states

Symbol	Parameter	Test conditions	Min.	Typ.	Max.	Unit
$V_{(BR)DSS}$	Drain-source breakdown voltage	$I_D = 250 \mu A, V_{GS} = 0$	30			V
I_{DSS}	Zero gate voltage drain current ($V_{GS} = 0$)	$V_{DS} = \text{Max rating}$			1	μA
		$V_{DS} = \text{Max rating}, T_C = 125^{\circ}C$			10	μA
I_{GSS}	Gate-body leakage current ($V_{DS} = 0$)	$V_{GS} = \pm 18V$			± 100	nA
$V_{GS(th)}$	Gate threshold voltage	$V_{DS} = V_{GS}, I_D = 250 \mu A$	1			V
$R_{DS(on)}$	Static drain-source on resistance	$V_{GS} = 10V, I_D = 5.5A$		0.0085	0.0105	Ω
		$V_{GS} = 5V, I_D = 5.5A$		0.0145	0.0190	Ω

Table 4. Dynamic

Symbol	Parameter	Test conditions	Min.	Typ.	Max.	Unit
$g_{fs}^{(1)}$	Forward transconductance	$V_{DS} = 25V, I_D = 5.5A$		15		S
C_{iss}	Input capacitance	$V_{DS} = 25V, f = 1 \text{ MHz}, V_{GS} = 0$		1440		pF
C_{oss}	Output capacitance			560		pF
C_{rss}	Reverse transfer capacitance			135		pF
Q_g	Total gate charge	$V_{DD} = 15V, I_D = 11A, V_{GS} = 5V$		22.5	30	nC
Q_{gs}	Gate-source charge			9		nC
Q_{gd}	Gate-drain charge			12		nC

1. Pulsed: Pulse duration = 300 μs , duty cycle 1.5 .

Table 5. Switching times

Symbol	Parameter	Test conditions	Min.	Typ.	Max.	Unit
$t_{d(on)}$ t_r	Turn-on delay time	$V_{DD} = 15V, I_D = 5.5A, R_G = 4.7\Omega, V_{GS} = 5V$ <i>(see Figure 13)</i>		22		ns
	Rise time			39		ns
$t_{d(off)}$ t_f	Turn-off-delay time	$V_{DD} = 15V, I_D = 5.5A, R_G = 4.7\Omega, V_{GS} = 5V$ <i>(see Figure 13)</i>		23		ns
	Fall time			16		ns

Table 6. Source drain diode

Symbol	Parameter	Test conditions	Min	Typ.	Max	Unit
I_{SD}	Source-drain current				11	A
$I_{SDM}^{(1)}$	Source-drain current (pulsed)				44	A
$V_{SD}^{(2)}$	Forward on voltage	$I_{SD} = 11A, V_{GS} = 0$			1.2	V
t_{rr}	Reverse recovery time	$I_{SD} = 11A, V_{DD} = 20V$ $di/dt = 100A/\mu s,$ $T_j = 150^\circ C$ <i>(see Figure 15)</i>		42		ns
Q_{rr}	Reverse recovery charge			52		nC
I_{RRM}	Reverse recovery current			2.5		A

1. Pulse width limited by safe operating area.
2. Pulsed: Pulse duration = 300 μs , duty cycle 1.5 %

2.1 Electrical characteristics (curves)

Figure 1. Safe operating area

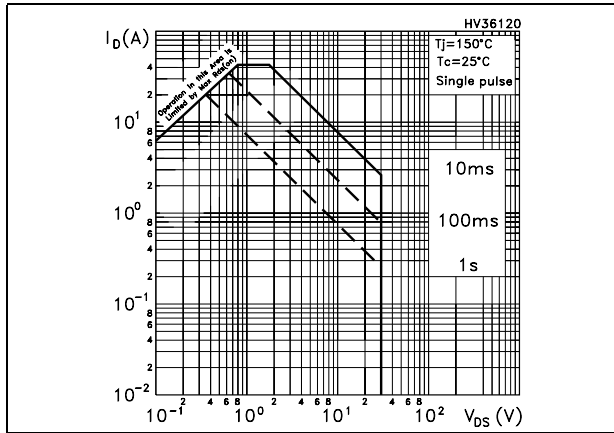

Figure 2. Thermal impedance

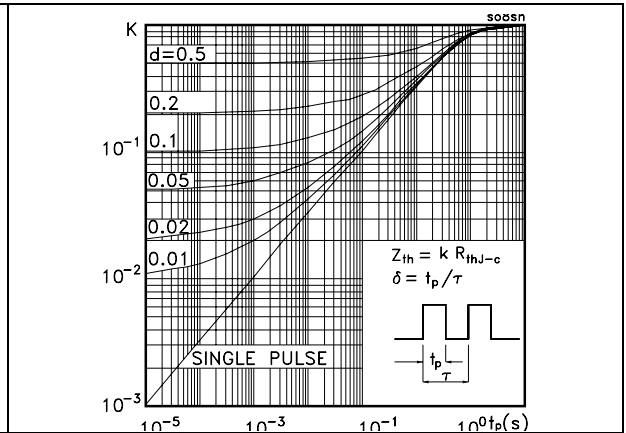

Figure 3. Output characteristics

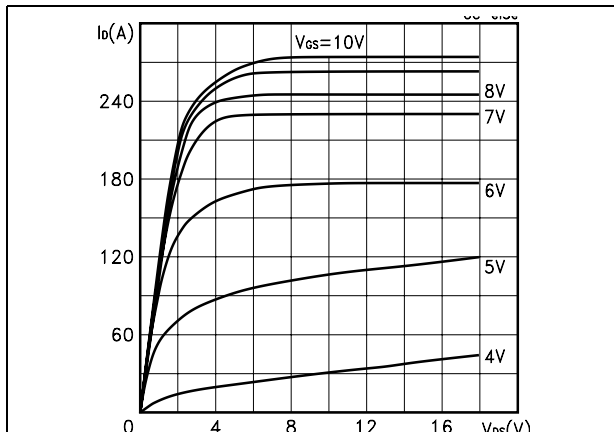

Figure 4. Transfer characteristics

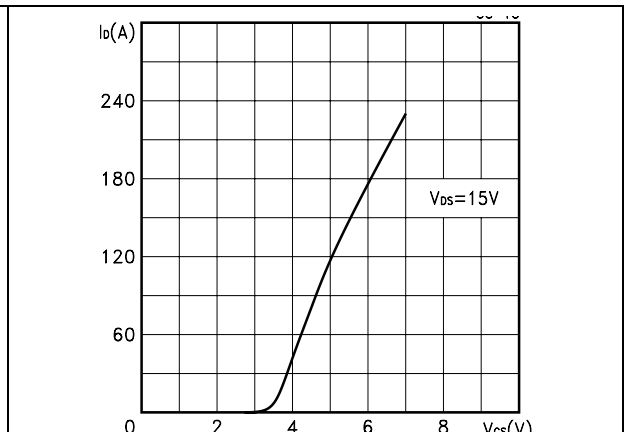

Figure 5. Transconductance

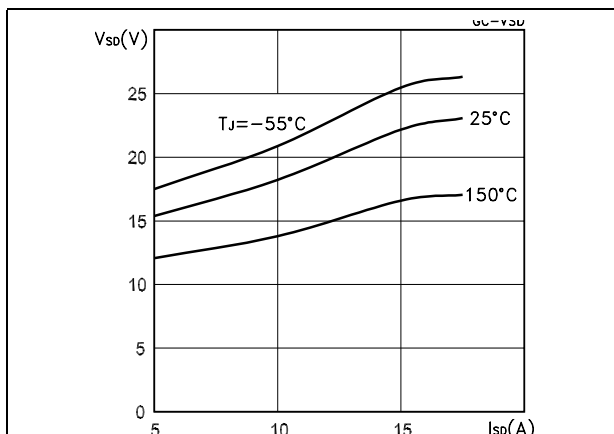

Figure 6. Static drain-source on resistance

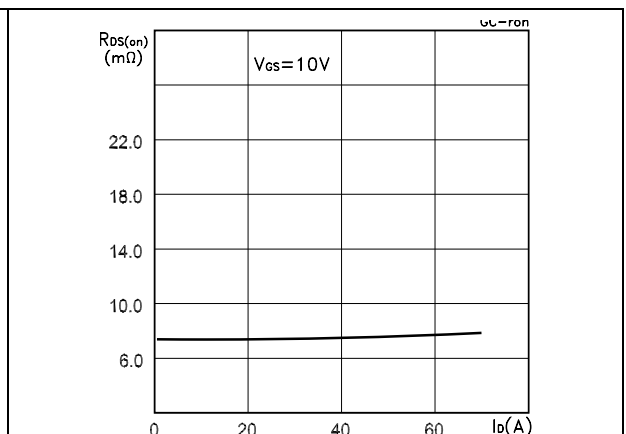

Figure 7. Gate charge vs gate-source voltage Figure 8. Capacitance variations

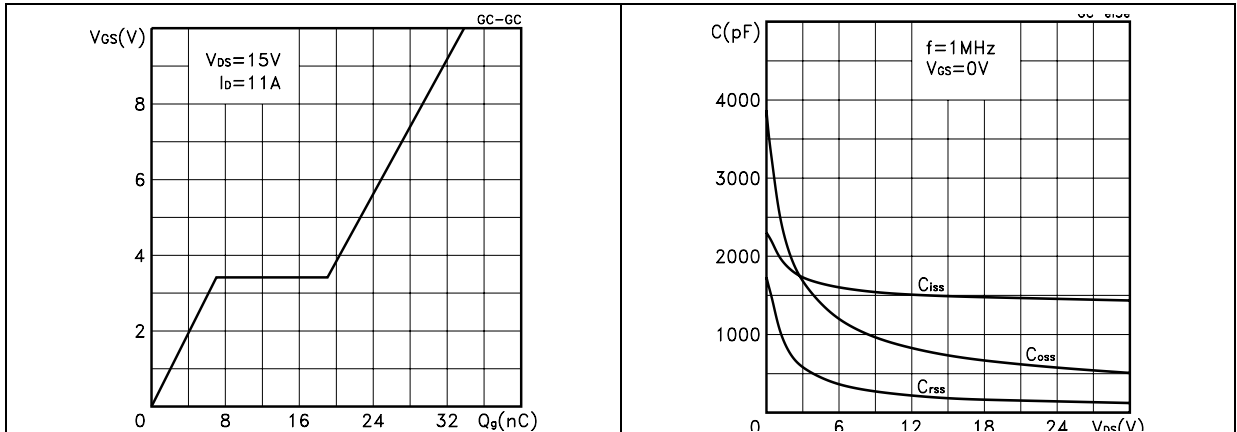

Figure 9. Normalized gate threshold voltage vs temperature Figure 10. Normalized on resistance vs temperature

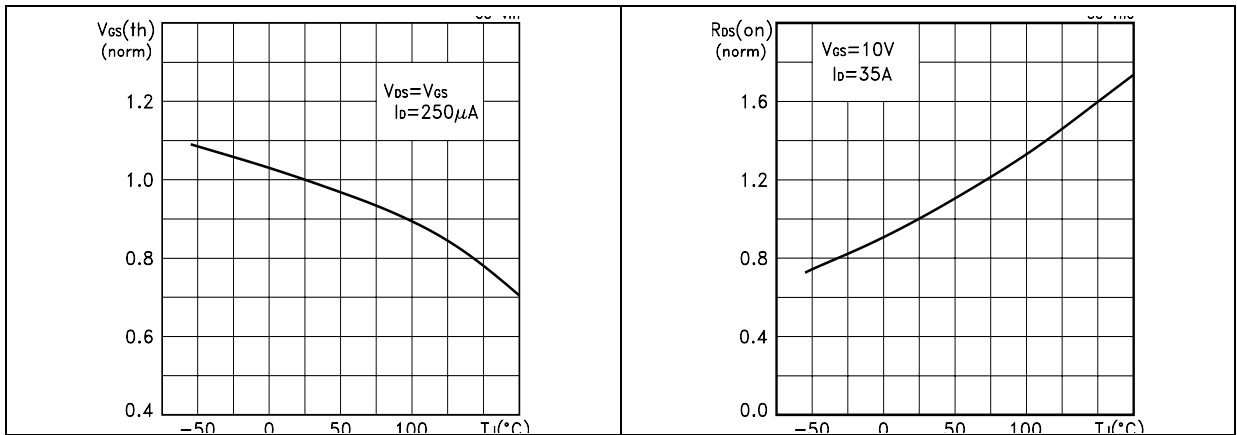
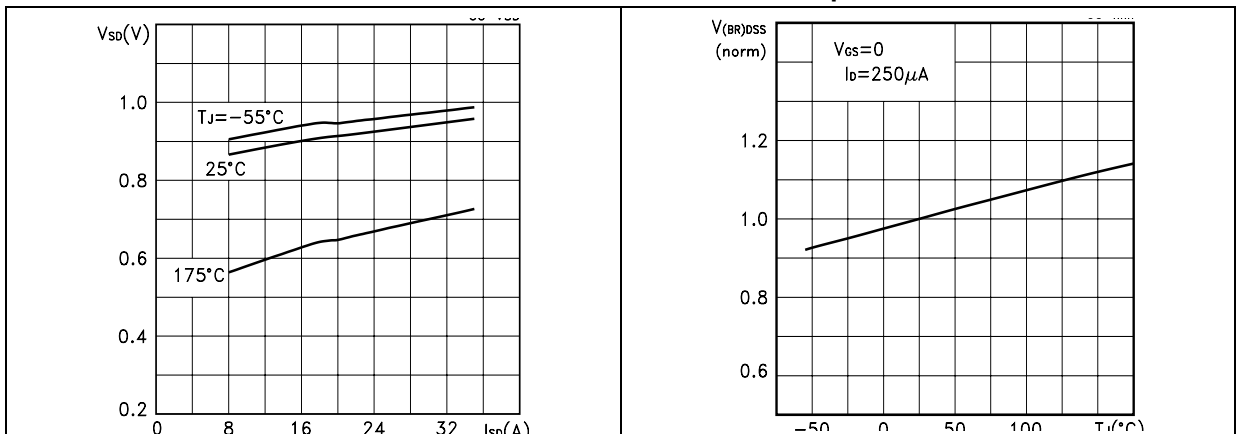

Figure 11. Source-drain diode forward characteristics Figure 12. Normalized Breakdown Voltage vs Temperature



3 Test circuit

Figure 13. Switching times test circuit for resistive load



Figure 14. Gate charge test circuit



Figure 15. Test circuit for inductive load switching and diode recovery times



Figure 16. Unclamped Inductive load test circuit



Figure 17. Unclamped inductive waveform

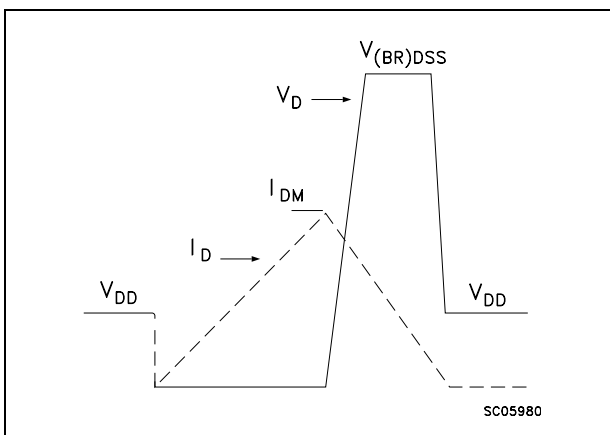
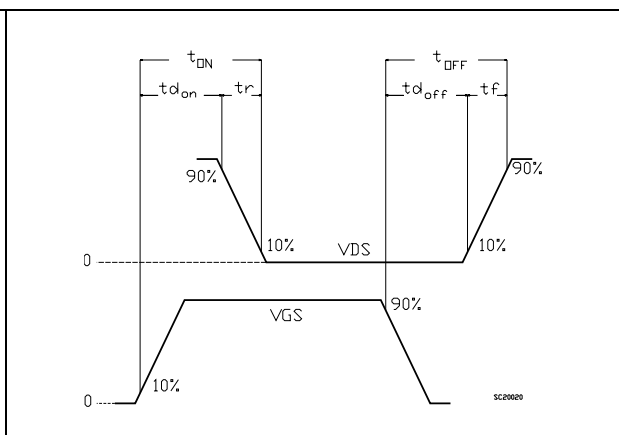

Figure 18. Switching time waveform



4 Package mechanical data

In order to meet environmental requirements, ST offers these devices in ECOPACK® packages. These packages have a Lead-free second level interconnect . The category of second level interconnect is marked on the package and on the inner box label, in compliance with JEDEC Standard JESD97. The maximum ratings related to soldering conditions are also marked on the inner box label. ECOPACK is an ST trademark. ECOPACK specifications are available at : www.st.com

SO-8 MECHANICAL DATA

DIM.	mm.			inch		
	MIN.	TYP.	MAX.	MIN.	TYP.	MAX.
A			1.75			0.068
a1	0.1		0.25	0.003		0.009
a2			1.65			0.064
a3	0.65		0.85	0.025		0.033
b	0.35		0.48	0.013		0.018
b1	0.19		0.25	0.007		0.010
C	0.25		0.5	0.010		0.019
c1	45 (typ.)					
D	4.8		5.0	0.188		0.196
E	5.8		6.2	0.228		0.244
e		1.27			0.050	
e3		3.81			0.150	
F	3.8		4.0	0.14		0.157
L	0.4		1.27	0.015		0.050
M			0.6			0.023
S	8 (max.)					

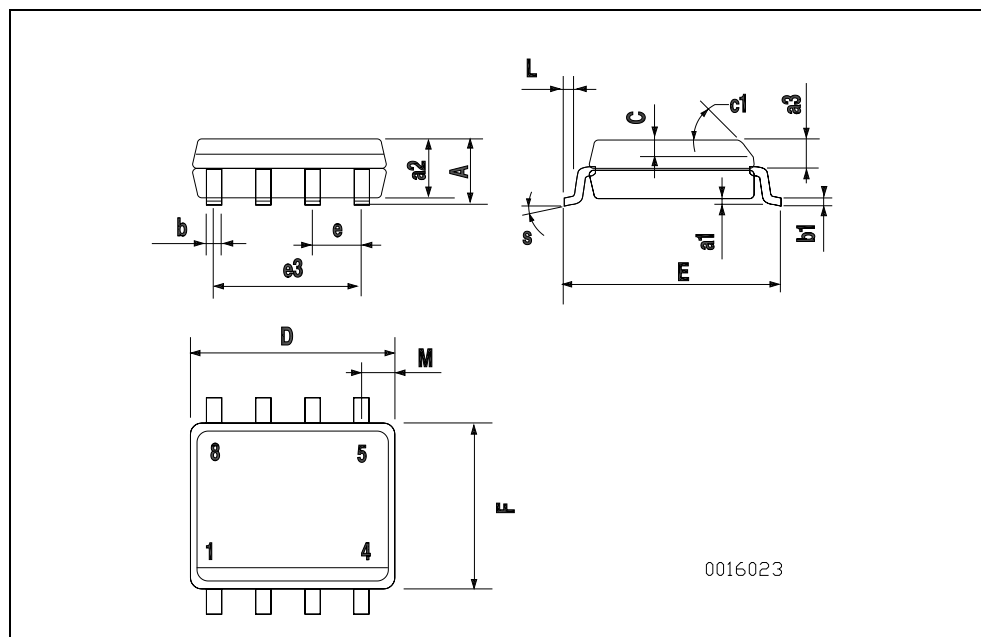

5 Revision history

Table 7. Revision history

Date	Revision	Changes
09-Sep-2004	9	Complete version
17-Aug-2006	10	The document has been reformatted
12-Jan-2007	11	Updates in Safe operating area

Please Read Carefully:

Information in this document is provided solely in connection with ST products. STMicroelectronics NV and its subsidiaries ("ST") reserve the right to make changes, corrections, modifications or improvements, to this document, and the products and services described herein at any time, without notice.

All ST products are sold pursuant to ST's terms and conditions of sale.

Purchasers are solely responsible for the choice, selection and use of the ST products and services described herein, and ST assumes no liability whatsoever relating to the choice, selection or use of the ST products and services described herein.

No license, express or implied, by estoppel or otherwise, to any intellectual property rights is granted under this document. If any part of this document refers to any third party products or services it shall not be deemed a license grant by ST for the use of such third party products or services, or any intellectual property contained therein or considered as a warranty covering the use in any manner whatsoever of such third party products or services or any intellectual property contained therein.

UNLESS OTHERWISE SET FORTH IN ST'S TERMS AND CONDITIONS OF SALE ST DISCLAIMS ANY EXPRESS OR IMPLIED WARRANTY WITH RESPECT TO THE USE AND/OR SALE OF ST PRODUCTS INCLUDING WITHOUT LIMITATION IMPLIED WARRANTIES OF MERCHANTABILITY, FITNESS FOR A PARTICULAR PURPOSE (AND THEIR EQUIVALENTS UNDER THE LAWS OF ANY JURISDICTION), OR INFRINGEMENT OF ANY PATENT, COPYRIGHT OR OTHER INTELLECTUAL PROPERTY RIGHT.

UNLESS EXPRESSLY APPROVED IN WRITING BY AN AUTHORIZED ST REPRESENTATIVE, ST PRODUCTS ARE NOT RECOMMENDED, AUTHORIZED OR WARRANTED FOR USE IN MILITARY, AIR CRAFT, SPACE, LIFE SAVING, OR LIFE SUSTAINING APPLICATIONS, NOR IN PRODUCTS OR SYSTEMS WHERE FAILURE OR MALFUNCTION MAY RESULT IN PERSONAL INJURY, DEATH, OR SEVERE PROPERTY OR ENVIRONMENTAL DAMAGE. ST PRODUCTS WHICH ARE NOT SPECIFIED AS "AUTOMOTIVE GRADE" MAY ONLY BE USED IN AUTOMOTIVE APPLICATIONS AT USER'S OWN RISK.

Resale of ST products with provisions different from the statements and/or technical features set forth in this document shall immediately void any warranty granted by ST for the ST product or service described herein and shall not create or extend in any manner whatsoever, any liability of ST.

ST and the ST logo are trademarks or registered trademarks of ST in various countries.

Information in this document supersedes and replaces all information previously supplied.

The ST logo is a registered trademark of STMicroelectronics. All other names are the property of their respective owners.

© 2007 STMicroelectronics - All rights reserved

STMicroelectronics group of companies

Australia - Belgium - Brazil - Canada - China - Czech Republic - Finland - France - Germany - Hong Kong - India - Israel - Italy - Japan - Malaysia - Malta - Morocco - Singapore - Spain - Sweden - Switzerland - United Kingdom - United States of America

www.st.com