

Part Number: SBC23-11EGWA

High Efficiency Red
Green

Features

- 2.3 INCH DIGIT HEIGHT.
- LOW CURRENT OPERATION.
- EXCELLENT CHARACTER APPEARANCE.
- HIGH LIGHT OUTPUT.
- EASY MOUNTING ON P.C. BOARDS OR SOCKETS.
- MULTICOLOR AVAILABLE.
- MECHANICALLY RUGGED.
- STANDARD : GRAY FACE, WHITE SEGMENT.
- RoHS COMPLIANT.

Description

The High Efficiency Red source color devices are made with Gallium Arsenide Phosphide on Gallium Phosphide Orange Light Emitting Diode.

The Green source color devices are made with Gallium Phosphide Green Light Emitting Diode.

Package Dimensions & Internal Circuit Diagram

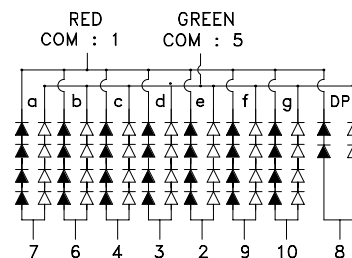
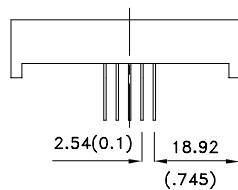
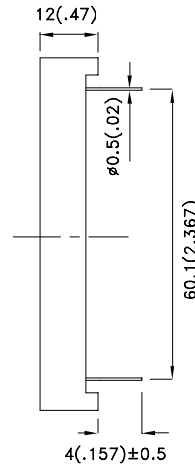
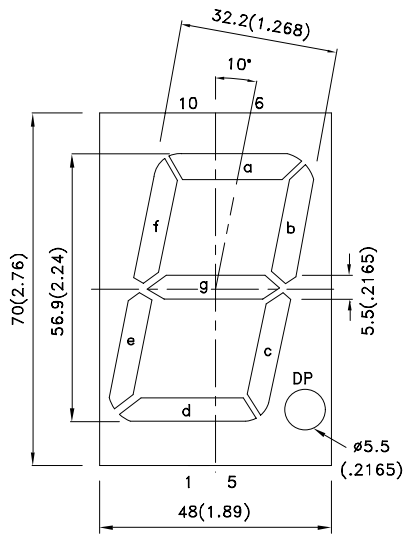

Notes:

1. All dimensions are in millimeters (inches), Tolerance is $\pm 0.25(0.01)$ unless otherwise noted.
2. Specifications are subject to change without notice.



Selection Guide

| Part No. | Dice | Lens Type | Iv (ucd) [1] @ 10mA | | Description |
|--------------|---------------------------------|----------------|------------------------|-------|-------------------------------------|
| | | | Min. | Typ. | |
| SBC23-11EGWA | High Efficiency Red (GaAsP/GaP) | WHITE DIFFUSED | 12000 | 55500 | Common Cathode. Rt. Hand Decimal |
| | Green (GaP) | | 12000 | 53000 | |

Note:

1. Luminous intensity/ luminous Flux: +/-15%.

Electrical / Optical Characteristics at TA=25°C

| Symbol | Parameter | Device | Typ. | Max. | Units | Test Conditions |
|-----------------------|--|------------------------------|------------------------------|--------------------------------|-------|--|
| λ_{peak} | Peak Wavelength | High Efficiency Red Green | 627 565 | | nm | I _F =20mA |
| λ_D [1] | Dominant Wavelength | High Efficiency Red Green | 625 568 | | nm | I _F =20mA |
| $\Delta\lambda_{1/2}$ | Spectral Line Half-width | High Efficiency Red Green | 45 30 | | nm | I _F =20mA |
| C | Capacitance | High Efficiency Red Green | 15 15 | | pF | V _F =0V;f=1MHz |
| V _F [2] | Forward Voltage Per Segment Or (DP) | High Efficiency Red Green | 8.0 (4.0) 8.8 (4.4) | 10.0 (5.0) 10.0 (5.0) | V | I _F =20mA |
| I _R | Reverse Current Per Segment Or (DP) | High Efficiency Red Green | | 10 (10) | uA | V _R =20V (V _R =10V) |

Notes:

1. Wavelength: +/-1nm.

2. Forward Voltage: +/-0.1V.

Absolute Maximum Ratings at TA=25°C

| Parameter | High Efficiency Red | Green | Units |
|---|-----------------------|-----------|-------|
| Power dissipation Per Segment Or (DP) | 300 (150) | 250 (125) | mW |
| DC Forward Current Per Segment Or (DP) | 30 (30) | 25 (25) | mA |
| Peak Forward Current [1] Per Segment Or (DP) | 160 (160) | 140 (140) | mA |
| Reverse Voltage Per Segment Or (DP) | 20 (10) | | V |
| Operating/Storage Temperature | -40°C To +85°C | | |
| Lead Solder Temperature [2] | 260°C For 3-5 Seconds | | |

Notes:

1. 1/10 Duty Cycle, 0.1ms Pulse Width.

2. 2mm below package base.

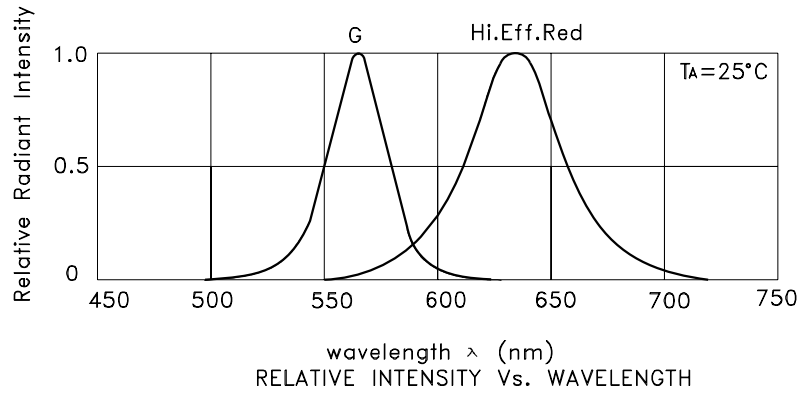

SBC23-11EGWA High Efficiency Red

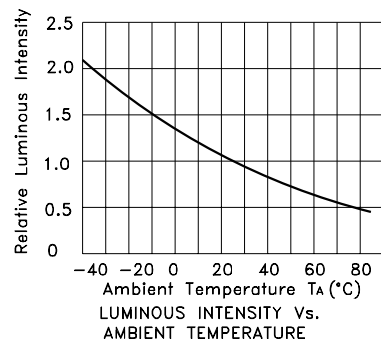
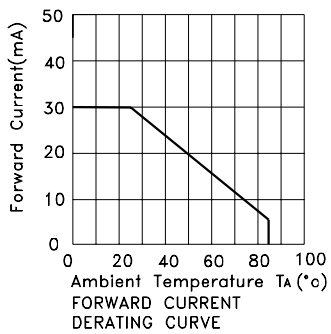
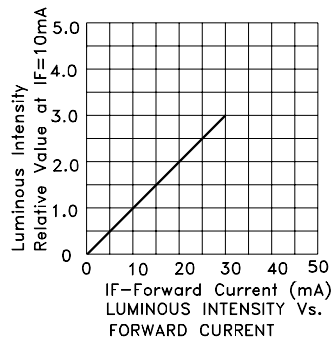
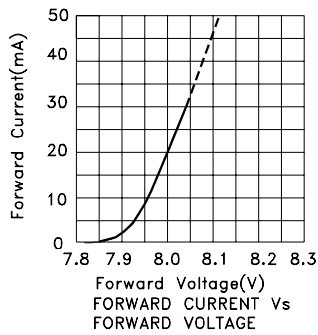

High Efficiency Red

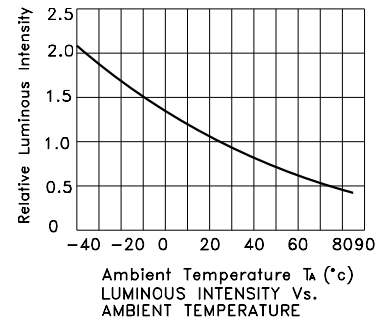
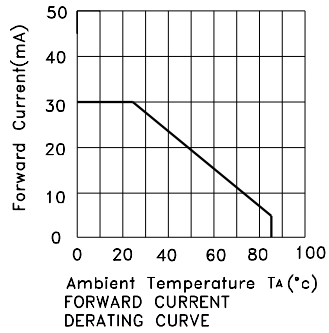
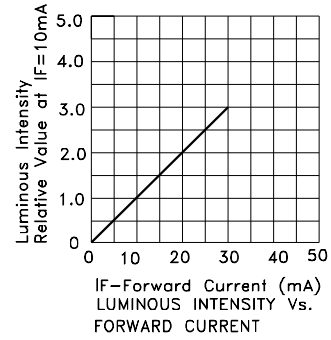
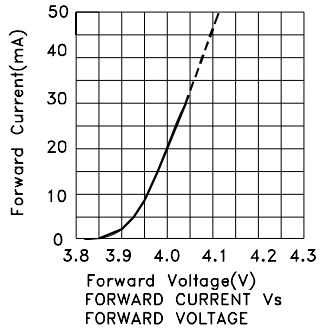

Green

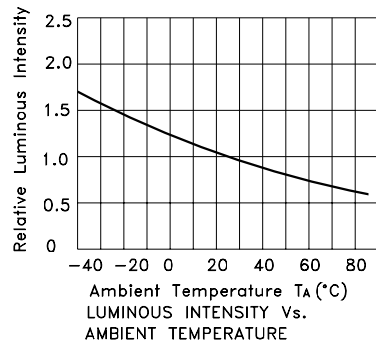
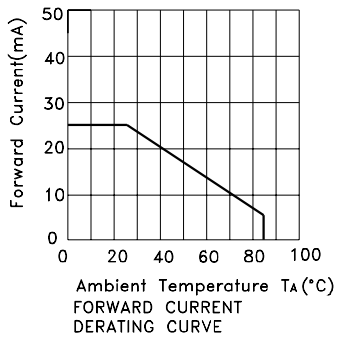
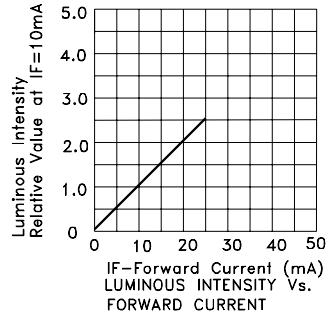
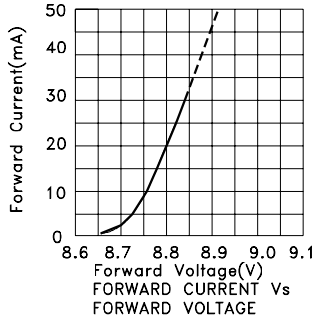

Green

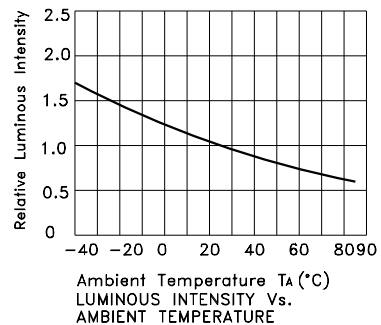
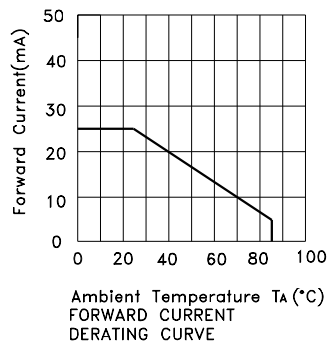
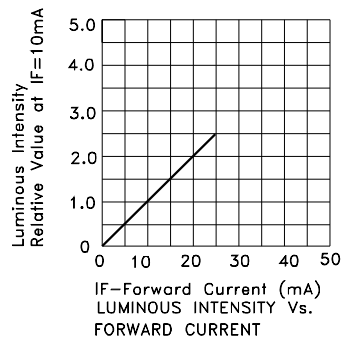
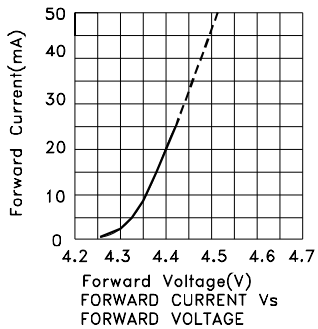

PACKING & LABEL SPECIFICATIONS

SBC23-11EGWA

