

L799EGW HIGH EFFICIENCY RED / GREEN
 L799SRSGW/CC
 SUPER BRIGHT RED / SUPER BRIGHT GREEN
 L799SURKMGKW HYPER RED / MEGA GREEN

Features

- UNIFORM LIGHT OUTPUT.
- LOW POWER CONSUMPTION.
- MILKY WHITE DIFFUSION LENS.
- 3 LEADS WITH ONE COMMON LEAD.
- THIRD COLOR (MIXED COLOR) AVAILABLE.
- SUPER BRIGHT VERSION AVAILABLE.
- I.C. COMPATIBLE.
- LONG LIFE - SOLID STATE RELIABILITY.

Description

The High Efficiency Red source color devices are made with Gallium Arsenide Phosphide on Gallium Phosphide Orange Light Emitting Diode.

The Green and Super Bright Green source color devices are made with Gallium Phosphide Green Light Emitting Diode.

The Super Bright Red source color devices are made with Gallium Aluminum Arsenide Red Light Emitting Diode.

The Hyper Red and Mega Green source color devices are made with DH InGaAlP on GaAs substrate Light Emitting Diode.

Package Dimensions

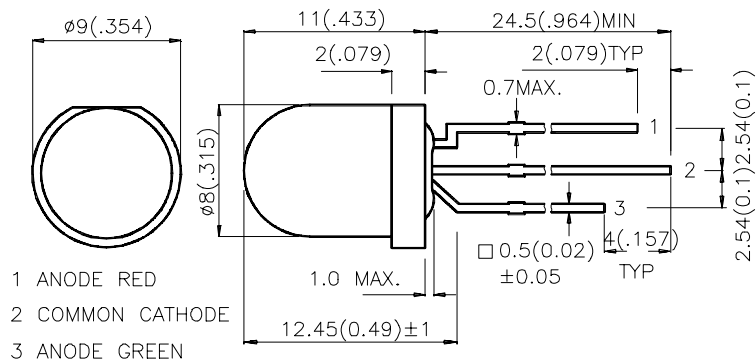

Notes:

1. All dimensions are in millimeters (inches).
2. Tolerance is $\pm 0.25(0.01)$ unless otherwise noted.
3. Lead spacing is measured where the lead emerge package.
4. Specifications are subject to change without notice.

Selection Guide

Part No.	Dice	Lens Type	Iv (mcd) @ 20 mA		Viewing Angle
			Min.	Typ.	
L799EGW	HIGH EFFICIENCY RED (GaAsP/GaP)	WHITE DIFFUSED	40	80	50°
	GREEN (GaP)		20	50	
L799SRSGW/CC	SUPER BRIGHT RED (GaAlAs)	WHITE DIFFUSED	100	200	50°
	SUPER BRIGHT GREEN (GaP)		20	50	
L799SURKMGKW	HYPER RED (InGaAlP)	WHITE DIFFUSED	380	600	50°
	Mega GREEN (InGaAlP)		50	130	

Note:

1. $\theta_{1/2}$ is the angle from optical centerline where the luminous intensity is 1/2 the optical centerline value.

Electrical / Optical Characteristics at T_A=25°C

Symbol	Parameter	Device	Typ.	Max.	Units	Test Conditions
λ_{peak}	Peak Wavelength	High Efficiency Red Green Super Bright Red Super Bright Green Hyper Red Mega Green	627 565 660 565 640 574		nm	IF=20mA
λ_D	Dominate Wavelength	High Efficiency Red Green Super Bright Red Super Bright Green Hyper Red Mega Green	625 568 640 568 630 570		nm	IF=20mA
$\Delta\lambda_{1/2}$	Spectral Line Halfwidth	High Efficiency Red Green Super Bright Red Super Bright Green Hyper Red Mega Green	45 30 20 30 28 20		nm	IF=20mA
C	Capacitance	High Efficiency Red Green Super Bright Red Super Bright Green Hyper Red Mega Green	15 15 45 15 35 15		pF	VF=0V;f=1MHz
V _F	Forward Voltage	High Efficiency Red Green Super Bright Red Super Bright Green Hyper Red Mega Green	2.0 2.2 1.85 2.2 1.95 2.1	2.5 2.5 2.5 2.5 2.5 2.5	V	IF=20mA
I _r	Reverse Current	All		10	uA	VR = 5V

Absolute Maximum Ratings at $T_A=25^\circ\text{C}$

Parameter	High Efficiency Red	Green	Super Bright Red	Super Bright Green	Hyper Red	Mega Green	Units
Power dissipation	105	105	100	105	170	105	mW
DC Forward Current	30	25	30	25	30	30	mA
Peak Forward Current [1]	160	140	155	140	185	205	mA
Reverse Voltage	5	5	5	5	5	5	V
Operating/Storage Temperature	-40°C To +85°C						
Lead Solder Temperature [2]	260°C For 5 Seconds						

Notes:

- 1/10 Duty Cycle, 0.1ms Pulse Width.
- 2.4mm below package base.

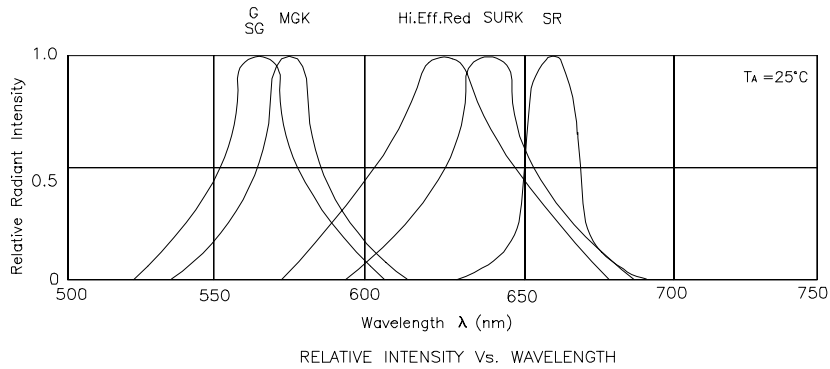

High Efficiency Red / Green L799EGW

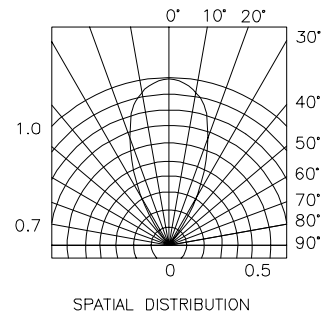
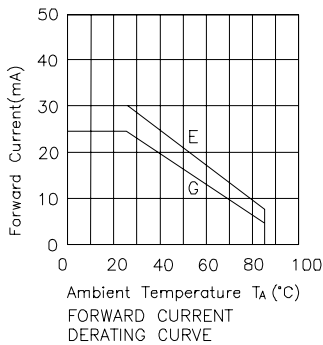
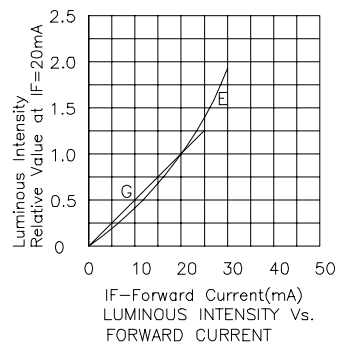
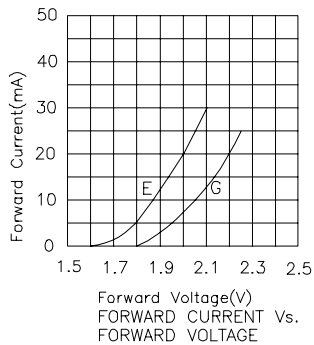

Super Bright Red / Super Bright Green L799SRSGW/CC

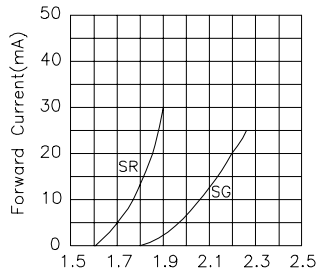

Forward Voltage(V)
FORWARD CURRENT Vs
FORWARD VOLTAGE

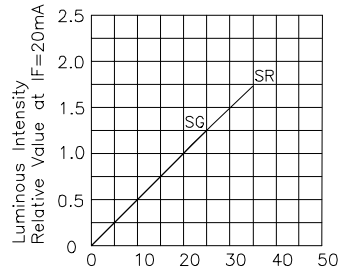

I_F -Forward Current (mA)
LUMINOUS INTENSITY Vs.
FORWARD CURRENT

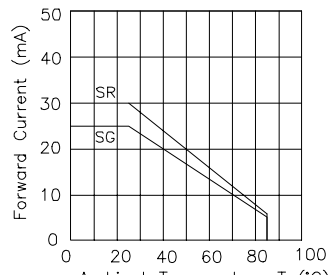

Ambient Temperature T_a (°C)
FORWARD CURRENT
DERATING CURVE

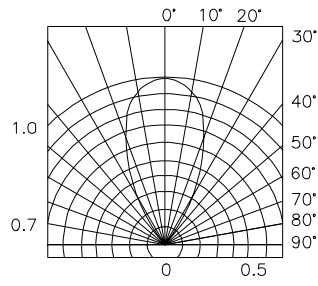

SPATIAL DISTRIBUTION

Hyper Red / Mega Green L799SURKMGKW

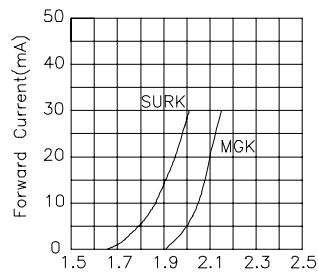

Forward Voltage(V)
FORWARD CURRENT Vs
FORWARD VOLTAGE

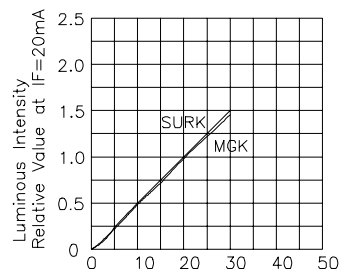

I_F -Forward Current (mA)
LUMINOUS INTENSITY Vs.
FORWARD CURRENT

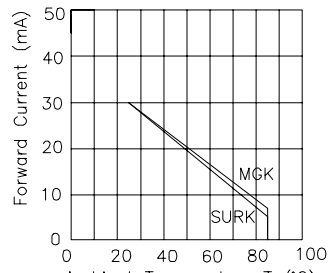

Ambient Temperature T_a (°C)
FORWARD CURRENT
DERATING CURVE

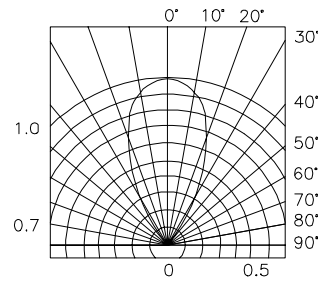

SPATIAL DISTRIBUTION