

Quad 2-Input Exclusive OR Gate

High-Speed Silicon-Gate CMOS

KK74AC86

The KK74AC86 is identical in pinout to the LS/ALS86, HC/HCT86. The device inputs are compatible with standard CMOS outputs; with pullup resistors, they are compatible with LS/ALS outputs.

- Outputs Directly Interface to CMOS, NMOS, and TTL
- Operating Voltage Range: 2.0 to 6.0 V
- Low Input Current: 1.0 μ A; 0.1 μ A @ 25°C
- High Noise Immunity Characteristic of CMOS Devices
- Outputs Source/Sink 24 mA

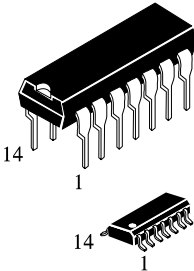

N SUFFIX
PLASTIC

D SUFFIX
SOIC

ORDERING INFORMATION
 KK74AC86N Plastic
 KK74AC86D SOIC
 $T_A = -40^\circ$ to 85° C for all packages

LOGIC DIAGRAM

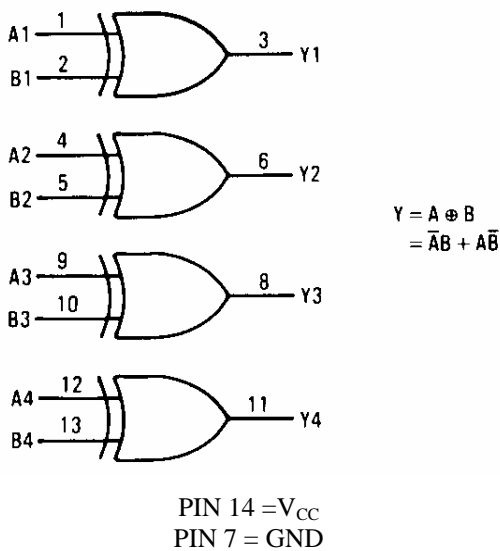

PIN ASSIGNMENT

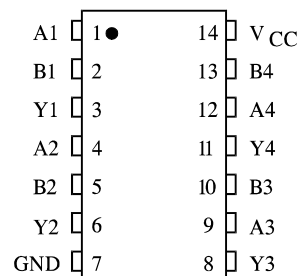

FUNCTION TABLE

Inputs		Output
A	B	Y
L	H	L
L	L	H
H	L	H
H	H	L

MAXIMUM RATINGS*

Symbol	Parameter	Value	Unit
V _{CC}	DC Supply Voltage (Referenced to GND)	-0.5 to +7.0	V
V _{IN}	DC Input Voltage (Referenced to GND)	-0.5 to V _{CC} +0.5	V
V _{OUT}	DC Output Voltage (Referenced to GND)	-0.5 to V _{CC} +0.5	V
I _{IN}	DC Input Current, per Pin	±20	mA
I _{OUT}	DC Output Sink/Source Current, per Pin	±50	mA
I _{CC}	DC Supply Current, V _{CC} and GND Pins	±50	mA
P _D	Power Dissipation in Still Air, Plastic DIP+ SOIC Package+	750 500	mW
T _{stg}	Storage Temperature	-65 to +150	°C
T _L	Lead Temperature, 1 mm from Case for 10 Seconds (Plastic DIP or SOIC Package)	260	°C

*Maximum Ratings are those values beyond which damage to the device may occur. Functional operation should be restricted to the Recommended Operating Conditions.

+Derating - Plastic DIP: - 10 mW/°C from 65° to 125°C

SOIC Package: - 7 mW/°C from 65° to 125°C

RECOMMENDED OPERATING CONDITIONS

Symbol	Parameter	Min	Max	Unit
V _{CC}	DC Supply Voltage (Referenced to GND)	2.0	6.0	V
V _{IN} , V _{OUT}	DC Input Voltage, Output Voltage (Referenced to GND)	0	V _{CC}	V
T _J	Junction Temperature (PDIP)		140	°C
T _A	Operating Temperature, All Package Types	-40	+85	°C
I _{OH}	Output Current - High		-24	mA
I _{OL}	Output Current - Low		24	mA
t _r , t _f	Input Rise and Fall Time * (except Schmitt Inputs)	V _{CC} =3.0 V V _{CC} =4.5 V V _{CC} =5.5 V	0 150 40 25	ns/V

* V_{IN} from 30% to 70% V_{CC}

This device contains protection circuitry to guard against damage due to high static voltages or electric fields. However, precautions must be taken to avoid applications of any voltage higher than maximum rated voltages to this high-impedance circuit. For proper operation, V_{IN} and V_{OUT} should be constrained to the range GND ≤ (V_{IN} or V_{OUT}) ≤ V_{CC}.

Unused inputs must always be tied to an appropriate logic voltage level (e.g., either GND or V_{CC}). Unused outputs must be left open.

DC ELECTRICAL CHARACTERISTICS (Voltages Referenced to GND)

Symbol	Parameter	Test Conditions	V _{CC} V	Guaranteed Limits		Unit
				25 °C	-40°C to 85°C	
V _{IH}	Minimum High-Level Input Voltage	V _{OUT} =0.1 V or V _{CC} -0.1 V	3.0	2.1	2.1	V
			4.5	3.15	3.15	
			5.5	3.85	3.85	
V _{IL}	Maximum Low - Level Input Voltage	V _{OUT} =0.1 V or V _{CC} -0.1 V	3.0	0.9	0.9	V
			4.5	1.35	1.35	
			5.5	1.65	1.65	
V _{OH}	Minimum High-Level Output Voltage	I _{OUT} ≤ -50 μA	3.0	2.9	2.9	V
			4.5	4.4	4.4	
			5.5	5.4	5.4	
		*V _{IN} =V _{IH} or V _{IL} I _{OH} =-12 mA	3.0	2.56	2.46	
		I _{OH} =-24 mA I _{OH} =-24 mA	4.5	3.86	3.76	
5.5	4.86	4.76				
V _{OL}	Maximum Low-Level Output Voltage	I _{OUT} ≤ 50 μA	3.0	0.1	0.1	V
			4.5	0.1	0.1	
			5.5	0.1	0.1	
		*V _{IN} =V _{IH} or V _{IL} I _{OL} =12 mA	3.0	0.36	0.44	
		I _{OL} =24 mA I _{OL} =24 mA	4.5	0.36	0.44	
5.5	0.36	0.44				
I _{IN}	Maximum Input Leakage Current	V _{IN} =V _{CC} or GND	5.5	±0.1	±1.0	μA
I _{OLD}	+Minimum Dynamic Output Current	V _{OLD} =1.65 V Max	5.5		75	mA
I _{OHD}	+Minimum Dynamic Output Current	V _{OHD} =3.85 V Min	5.5		-75	mA
I _{CC}	Maximum Quiescent Supply Current (per Package)	V _{IN} =V _{CC} or GND	5.5	4.0	40	μA

* All outputs loaded; thresholds on input associated with output under test.

+Maximum test duration 2.0 ms, one output loaded at a time.

Note: I_{IN} and I_{CC} @ 3.0 V are guaranteed to be less than or equal to the respective limit @ 5.5 V V_{CC}

AC ELECTRICAL CHARACTERISTICS ($C_L=50\text{pF}$, Input $t_r=t_f=3.0\text{ ns}$)

Symbol	Parameter	V_{CC}^* V	Guaranteed Limits				Unit
			25 °C		-40°C to 85°C		
			Min	Max	Min	Max	
t_{PLH}	Propagation Delay, Input A or B to Output Y (Figure 1)	3.3 5.0	2.0 1.5	11.5 8.5	1.5 1.0	12.5 9.0	ns
t_{PHL}	Propagation Delay, Input A or B to Output Y (Figure 1)	3.3 5.0	2.0 1.5	11.5 8.5	1.5 1.0	12.5 9.5	ns
C_{IN}	Maximum Input Capacitance	5.0	4.5		4.5		pF
C_{PD}	Power Dissipation Capacitance	Typical @25°C, $V_{CC}=5.0\text{ V}$				pF	
		35					

*Voltage Range 3.3 V is 3.3 V \pm 0.3 V
 Voltage Range 5.0 V is 5.0 V \pm 0.5 V

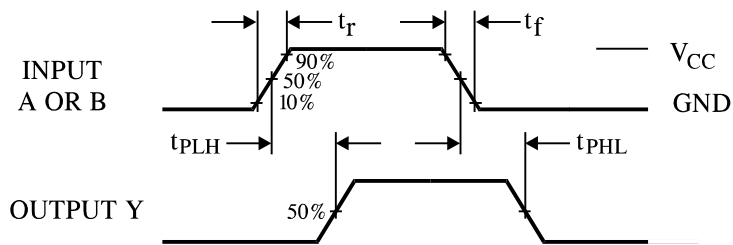
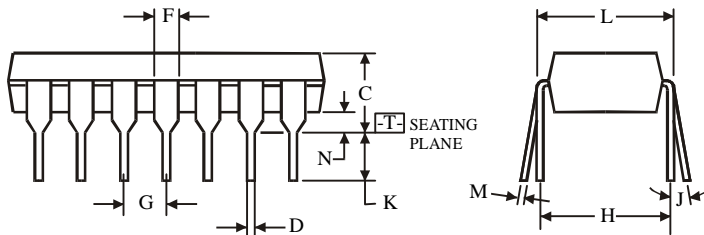
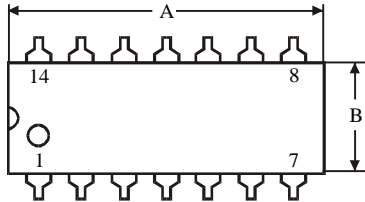

Figure 1. Switching Waveforms

**N SUFFIX PLASTIC DIP
(MS - 001AA)**



$\oplus 0.25 (0.010) \text{ (M) T}$

NOTES:

- Dimensions "A", "B" do not include mold flash or protrusions.
Maximum mold flash or protrusions 0.25 mm (0.010) per side.

Symbol	Dimension, mm	
	MIN	MAX
A	18.67	19.69
B	6.1	7.11
C		5.33
D	0.36	0.56
F	1.14	1.78
G	2.54	
H	7.62	
J	0°	10°
K	2.92	3.81
L	7.62	8.26
M	0.2	0.36
N	0.38	

**D SUFFIX SOIC
(MS - 012AB)**

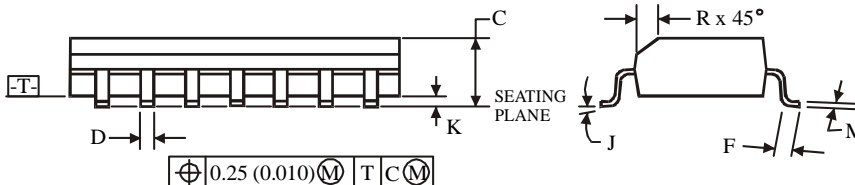
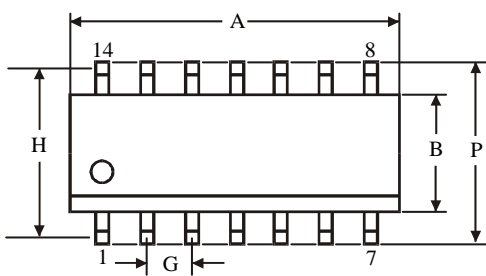
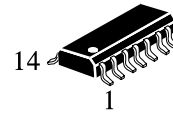

$\oplus 0.25 (0.010) \text{ (M) T C (M)}$

NOTES:

- Dimensions A and B do not include mold flash or protrusion.
- Maximum mold flash or protrusion 0.15 mm (0.006) per side for A; for B - 0.25 mm (0.010) per side.

Symbol	Dimension, mm	
	MIN	MAX
A	8.55	8.75
B	3.8	4
C	1.35	1.75
D	0.33	0.51
F	0.4	1.27
G	1.27	
H	5.27	
J	0°	8°
K	0.1	0.25
M	0.19	0.25
P	5.8	6.2
R	0.25	0.5