

# ZXRE125

## SOT23 MICROPOWER 1.22V VOLTAGE REFERENCE

### SUMMARY

#### DESCRIPTION

The ZXRE125 is a bandgap circuit designed to achieve a precision micropower voltage reference of 1.22 volts. The device is available in the small outline SOT23 surface mount package which is ideal for applications where space saving is important.

SOT23 tolerance is available to 0.5% for precision applications. Excellent performance is maintained over the 8 $\mu$ A to 20mA operating current range with a typical temperature coefficient of only 20ppm/ $^{\circ}$ C. The device has been designed to be highly tolerant of capacitive loads so maintaining excellent stability.

This device offers a SOT23 pin for pin compatible replacement of the ZRA124 and ZRA125 series of voltage references. An E-Line (TO92 style) package is also available.

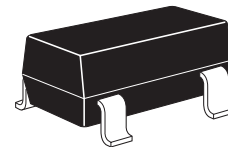

SOT23



E-line

#### FEATURES

- High performance 1.220V reference
- 0.5%, 1%, 2% and 3% tolerance
- 4 $\mu$ A knee current
- 20ppm/ $^{\circ}$ C typical temperature coefficient
- Unconditionally stable
- Small outline SOT23

#### APPLICATIONS

- Battery powered equipment
- Precision power supplies
- Portable instrumentation
- Portable communications devices
- Data acquisition systems

SOT23  
Package Suffix - F

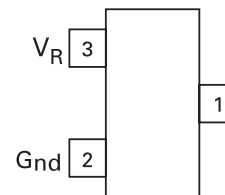

Top view -  
Pin 1 floating or  
connected to pin 2

E-line  
Package Suffix - R

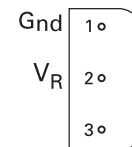

Bottom view -  
Pin 3 floating or  
connected to pin 1

#### ORDERING INFORMATION

DEVICE	TOL%	GRADE	PACKAGE	PARTMARKING	REEL	QUANTITY PER REEL
ZXRE125CFTA	0.5	C	SOT23	12J	7"	3,000
ZXRE125DFTA	1	D	SOT23	12H	7"	3,000
ZXRE125EFTA	2	E	SOT23	12G	7"	3,000
ZXRE125FFTA	3	F	SOT23	12F	7"	3,000
ZXRE125DRSTOA	1		E-line	ZXRE125D	-	2,000
ZXRE125ERSTOA	2		E-line	ZXRE125E	-	2,000
ZXRE125FRSTOA	3		E-line	ZXRE125F	-	2,000

#### NOTE:

E-line parts available loose in boxes of 2,000 units, omit "STOA" from order code i.e. ZXRE125DR

# ZXRE125

## ABSOLUTE MAXIMUM RATINGS

PARAMETER	SYMBOL	LIMIT	UNIT
Reverse current	$V_Z$	30	mA
Forward current		10	mA
Operating temperature	$T_{OMP}$	-40 to 85	°C
Storage temperature	$T_{STG}$	-55 to 125	°C

## POWER DISSIPATION (at $T_{amb} = 25^{\circ}\text{C}$ , $T_{jmax} = 25^{\circ}\text{C}$ )

PACKAGE	VALUE	UNIT
SOT23	330	mW
E-line	500	mW

# ZXRE125

SCHEMATIC DIAGRAM

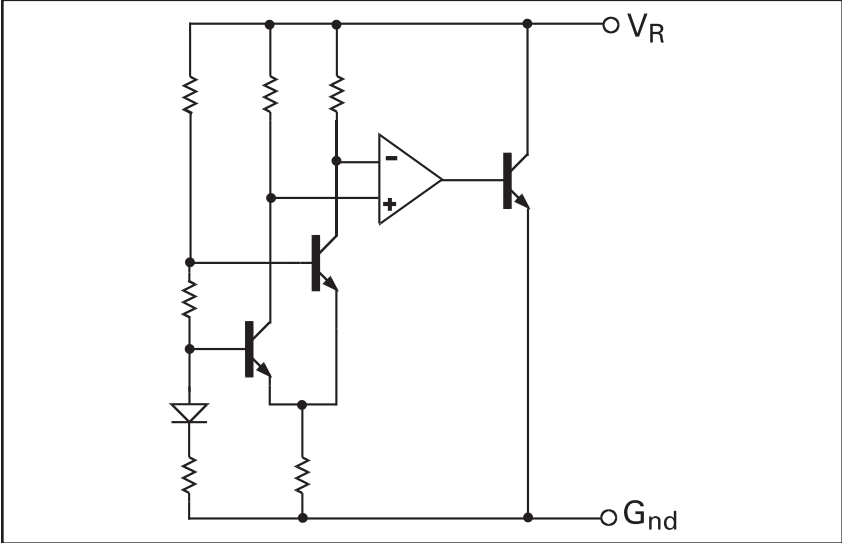

APPLICATIONS CIRCUIT

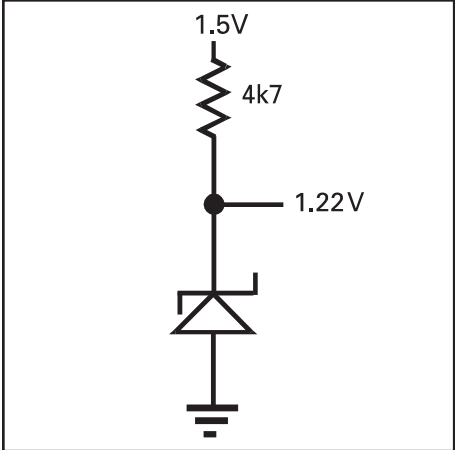

# ZXRE125

ELECTRICAL CHARACTERISTICS (at  $T_{amb} = 25^{\circ}\text{C}$  unless otherwise stated)

PARAMETER	SYMBOL	CONDITIONS	MIN.	TYP.	MAX.	GRADE/ TOL%	UNITS
Reverse Breakdown Voltage	$V_R$	$I_R = 100\mu\text{A}$	1.214	1.220	1.226	C/0.5 <sup>(1)</sup>	V
			1.208	1.220	1.232	D/1	V
			1.196	1.220	1.244	E/2	V
			1.183	1.220	1.257	F/3	V
Minimum Knee Current	$I_{MIN}$			4	8		$\mu\text{A}$
Recommended Operating Current Range	$I_R$		0.008		20		mA
Average Reverse Breakdown Voltage Temperature Coefficient	$T_C^{(2)}$	$I_{R(min)}$ to $I_{R(max)}$		20	75		ppm/ $^{\circ}\text{C}$
Reverse Breakdown Change with Current Voltage	$\frac{\Delta V_R}{\Delta I_R}$	$I_R = 30\mu\text{A}$ to 1 mA $I_R = 1\text{mA}$ to 5mA			1		mV
					10		mV
Reverse Dynamic Impedance	$Z_R$	$I_R = 1\text{mA}$ $f = 100\text{Hz}$ $I_{AC} = 0.1I_R$		0.2	0.6		$\Omega$
Wideband Noise Voltage	$E_N$	$I_R = 8\mu\text{A}$ to $100\mu\text{A}$ $f = 10\text{Hz}$ to $10\text{kHz}$		60			$\mu\text{V(rms)}$

**NOTE:**

(1) 0.5% SOT23 only

$$(2) T_C = \frac{(V_{R(max)} - V_{R(min)}) \times 1000000}{V_R \times (T_{(max)} - T_{(min)})}$$

$V_{R(max)} - V_{R(min)}$  is the maximum deviation in reference voltage measured over the full operating temperature range

### REVERSE CHARACTERISTICS

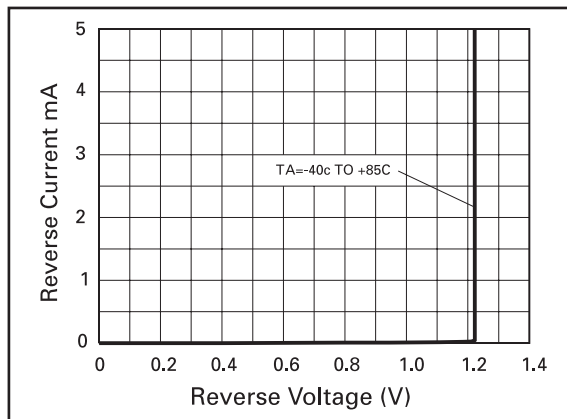

## TYPICAL CHARACTERISTICS

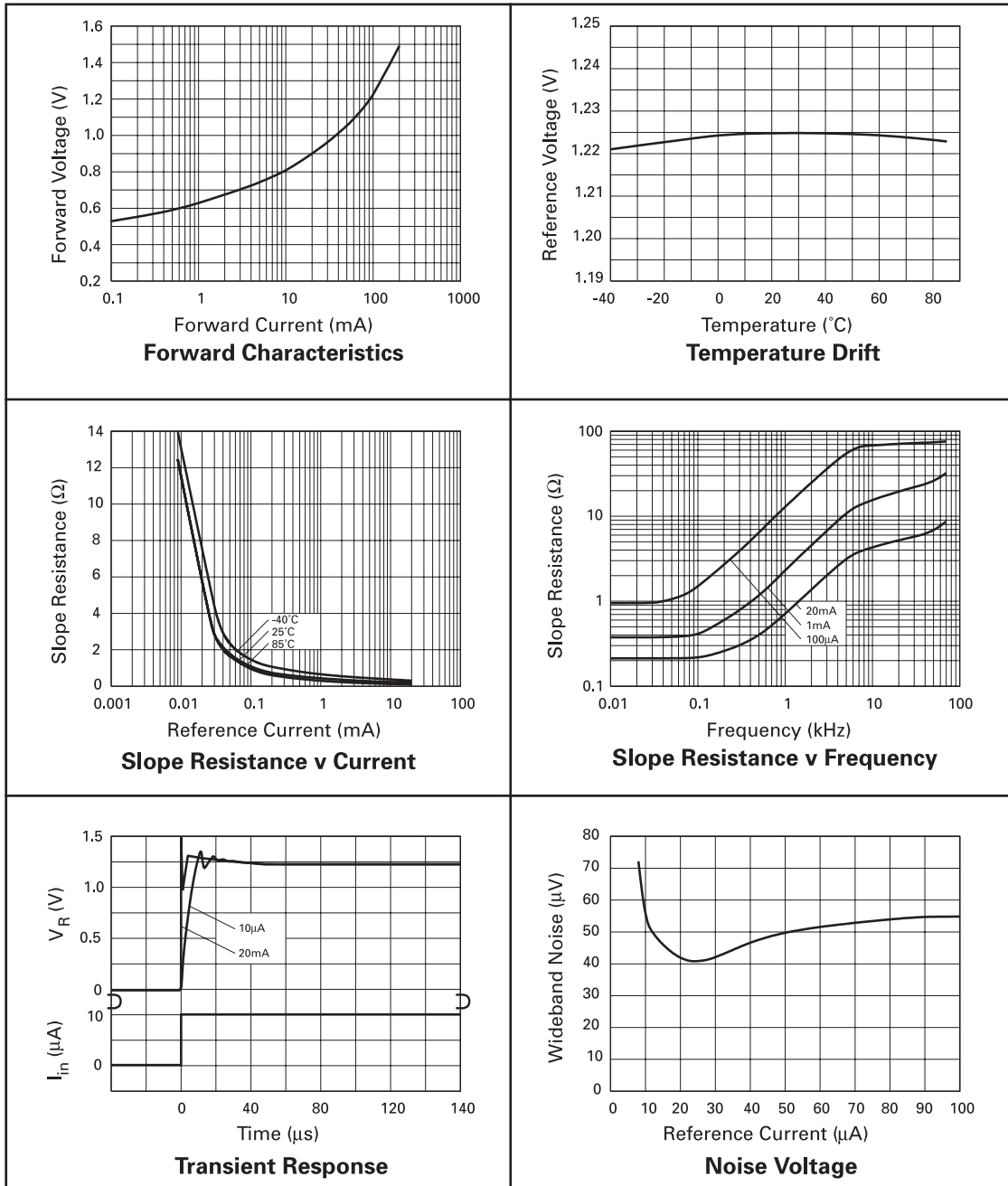

# ZXRE125

## SOT23 PACKAGE OUTLINE AND PAD LAYOUT DETAILS

### PACKAGE OUTLINE

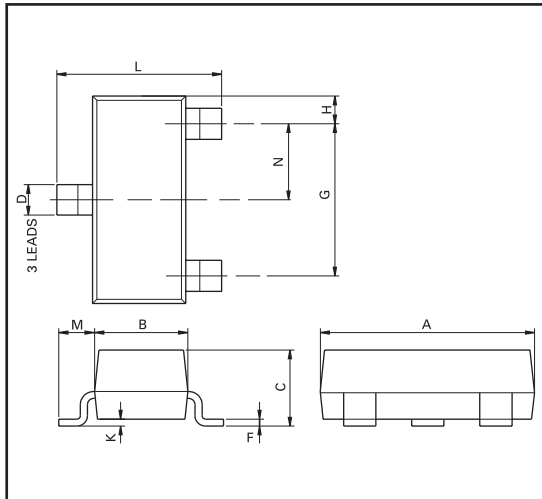

### PAD LAYOUT

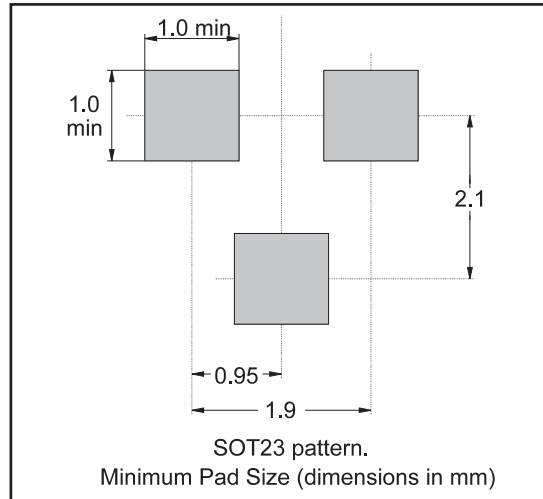

Controlling dimensions are in millimetres. Approximate conversions are given in inches

### PACKAGE DIMENSIONS

DIM	Millimetres		Inches		DIM	Millimetres		Inches	
	Min	Max	Min	Max		Min	Max	Min	Max
A	2.67	3.05	0.105	0.120	G	NOM 1.9		NOM 0.037	
B	1.20	1.40	0.047	0.055	K	0.01	0.10	0.0004	0.004
C	-	1.10	-	0.043	L	2.10	2.50	0.083	0.0985
D	0.37	0.53	0.0145	0.021	N	NOM 0.95		NOM 0.037	
F	0.085	0.15	0.0033	0.0059					

# ZXRE125

## E-LINE PACKAGE OUTLINE

### PACKAGE OUTLINE

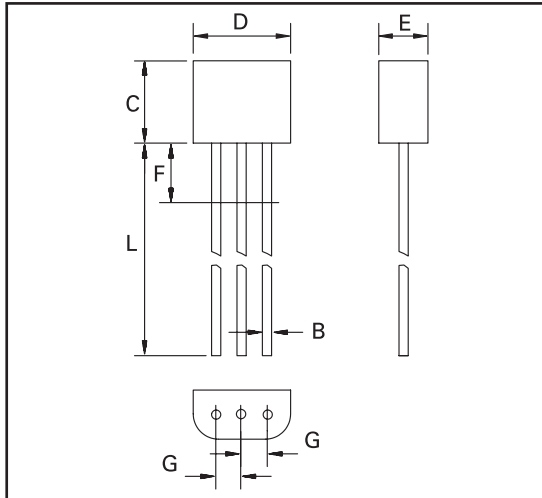

Controlling dimensions are in millimetres. Approximate conversions are given in inches

### PACKAGE DIMENSIONS

DIM	Millimetres		Inches	
	Min	Max	Min	Max
A	0.41	0.495	0.016	0.0195
B	0.41	0.495	0.016	0.0195
C	3.61	4.01	0.142	0.158
D	4.37	4.77	0.172	0.188
E	2.16	2.41	0.085	0.095
F	—	2.50	—	0.098
G	1.27 NOM		0.050 NOM	
L	13.00	13.97	0.512	0.550

© Zetex plc 2003

#### Europe

Zetex plc  
Fields New Road  
Chadderton  
Oldham, OL9 8NP  
United Kingdom  
Telephone (44) 161 622 4444  
Fax: (44) 161 622 4446  
hq@zetex.com

Zetex GmbH  
Streitfeldstraße 19  
D-81673 München  
Germany  
Telefon: (49) 89 45 49 49 0  
Fax: (49) 89 45 49 49 49  
europe.sales@zetex.com

#### Americas

Zetex Inc  
700 Veterans Memorial Hwy  
Hauppauge, NY 11788  
USA  
Telephone: (1) 631 360 2222  
Fax: (1) 631 360 8222  
usa.sales@zetex.com

#### Asia Pacific

Zetex (Asia) Ltd  
3701-04 Metroplaza Tower 1  
Hing Fong Road  
Kwai Fong  
Hong Kong  
Telephone: (852) 26100 611  
Fax: (852) 24250 494  
asia.sales@zetex.com

These offices are supported by agents and distributors in major countries world-wide.

This publication is issued to provide outline information only which (unless agreed by the Company in writing) may not be used, applied or reproduced for any purpose or form part of any order or contract or be regarded as a representation relating to the products or services concerned. The Company reserves the right to alter without notice the specification, design, price or conditions of supply of any product or service.

For the latest product information, log on to [www.zetex.com](http://www.zetex.com)

ISSUE 7 - OCTOBER 2003