

LCD EMI Filter Array with ESD Protection

Features

- Eight channels of EMI filtering
- $\pm 30\text{kV}$ ESD protection on each channel (IEC 61000-4-2 Level 4, contact discharge)
- $\pm 30\text{kV}$ ESD protection on each channel (HBM)
- Better than 35dB of attenuation at 800-2700MHz
- Chip Scale Package features extremely low lead inductance for optimum filter and ESD performance
- 20-bump, 4.000mm x 1.458mm footprint Chip Scale Package
- OptiGuard™ coated version available for improved reliability at assembly
- Lead-free version available

Applications

- LCD data lines in mobile handsets
- EMI filtering & ESD protection for high-speed I/O ports
- EMI filtering for high-speed data lines
- Wireless handsets
- Cell phones
- Notebook computers
- PDAs / Handheld PCs

Product Description

California Micro Device's CM1405 is an EMI filter array with ESD protection, which integrates eight Pi-filters (C-R-C). The CM1405 has component values of 25pF-100 Ω -25pF. The parts include avalanche-type ESD diodes on every pin, which provide a very high level of protection for sensitive electronic components that may be subjected to electrostatic discharge (ESD). The ESD diodes connected to the filter ports are designed and characterized to safely dissipate ESD strikes of $\pm 30\text{kV}$, exceeding the maximum requirement of the IEC61000-4-2 international standard. Using the MIL-STD-883 (Method 3015) specification for Human Body Model (HBM) ESD, the pins are protected for contact discharges at greater than $\pm 30\text{kV}$.

This device is particularly well suited for portable electronics (e.g. mobile handsets, PDAs, notebook computers) because of its small package format and easy-to-use pin assignments. In particular, the CM1405 is ideal for EMI filtering and protecting data lines from ESD for the LCD display in mobile handsets.

The CM1405-03 incorporates OptiGuard™ coating which results in improved reliability at assembly and is available in space-saving, low-profile chip-scale packages with optional lead-free finishing.

Electrical Schematic

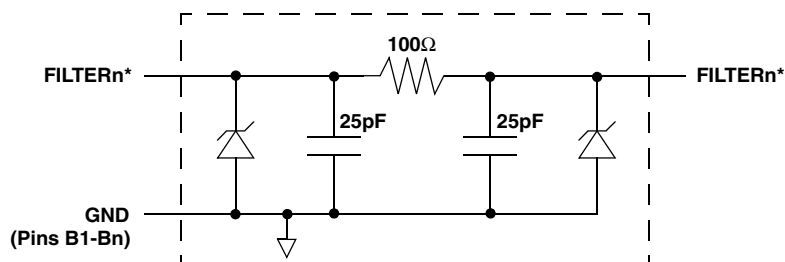

1 of 8 EMI Filtering + ESD Channels

* See Package/Pinout Diagram for expanded pin information.

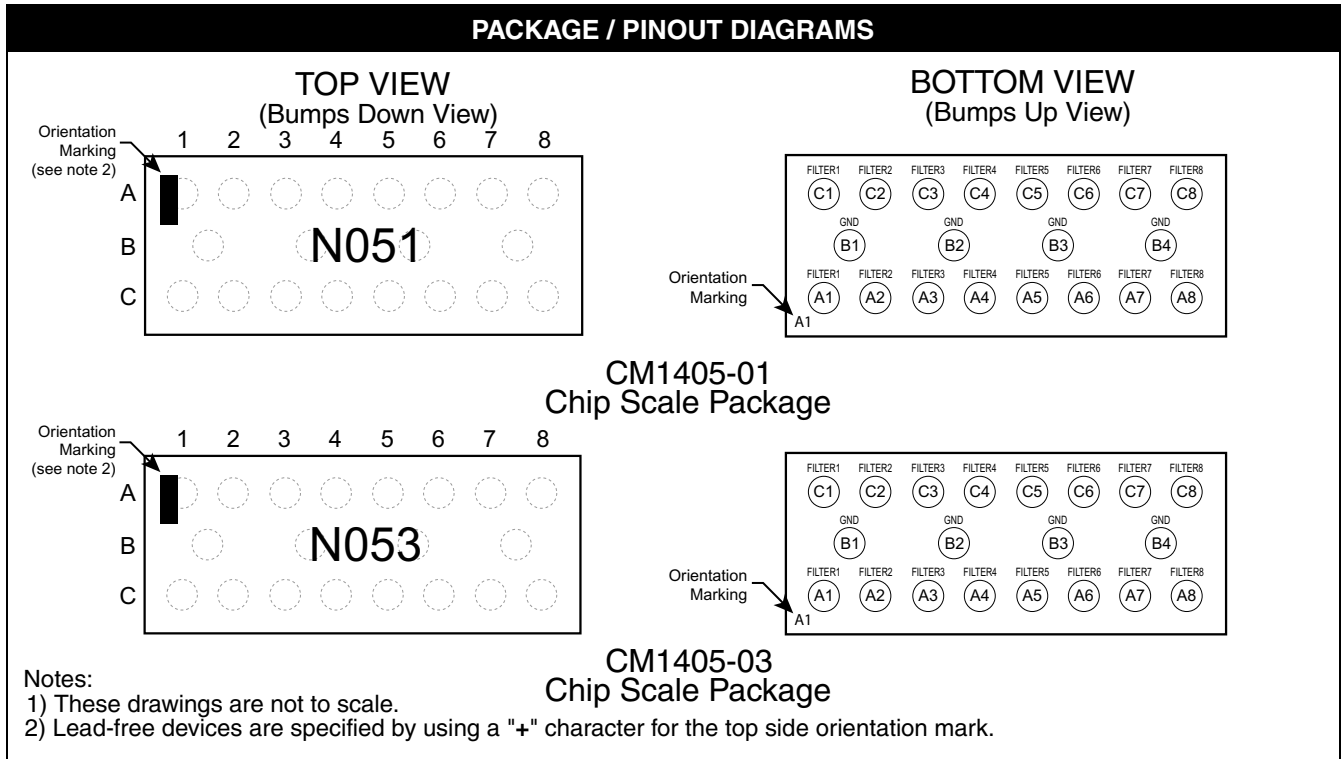

PIN DESCRIPTIONS

PIN(s)	NAME	DESCRIPTION	PIN(s)	NAME	DESCRIPTION
A1	FILTER1	Filter Channel 1	C1	FILTER1	Filter Channel 1
A2	FILTER2	Filter Channel 2	C2	FILTER2	Filter Channel 2
A3	FILTER3	Filter Channel 3	C3	FILTER3	Filter Channel 3
A4	FILTER4	Filter Channel 4	C4	FILTER4	Filter Channel 4
A5	FILTER5	Filter Channel 5	C5	FILTER5	Filter Channel 5
A6	FILTER6	Filter Channel 6	C6	FILTER6	Filter Channel 6
A7	FILTER7	Filter Channel 7	C7	FILTER7	Filter Channel 7
A8	FILTER8	Filter Channel 8	C8	FILTER8	Filter Channel 8
B1-B4	GND	Device Ground			

Ordering Information

PART NUMBERING INFORMATION

Bumps	PKG	Standard Finish				Lead-free Finish ²			
		No Coating		Optiguard™ Coated		No Coating		Optiguard™ Coated	
		Ordering Part Number ¹	Part Marking	Ordering Part Number ¹	Part Marking	Ordering Part Number ¹	Part Marking	Ordering Part Number ¹	Part Marking
20	CSP	CM1405-01CS	N051	CM1405-03CS	N053	CM1405-01CP	N051	CM1405-03CP	N053

Note 1: Parts are shipped in Tape & Reel form unless otherwise specified.

Note 2: Lead-free devices are specified by using a "+" character for the top side orientation mark.

Specifications

ABSOLUTE MAXIMUM RATINGS

PARAMETER	RATING	UNITS
Storage Temperature Range	-65 to +150	°C
DC Power per Resistor	100	mW
DC Package Power Rating	500	mW

STANDARD OPERATING CONDITIONS

PARAMETER	RATING	UNITS
Operating Temperature Range	-40 to +85	°C

ELECTRICAL OPERATING CHARACTERISTICS (SEE NOTE 1)

SYMBOL	PARAMETER	CONDITIONS	MIN	TYP	MAX	UNITS
R	Resistance		80	100	120	Ω
C	Capacitance	At 2.5V DC, 1MHz, 30mV AC	20	25	30	pF
V _{DIODE}	Diode Standoff Voltage	I _{DIODE} = 10μA	5.5			V
I _{LEAK}	Diode Leakage Current (reverse bias)	V _{DIODE} = 3.3V		100		nA
V _{SIG}	Signal Voltage Positive Clamp Negative Clamp	I _{LOAD} = 10mA I _{LOAD} = -10mA	5.6 -0.4	6.8 -0.8	9.0 -1.5	V V
V _{ESD}	In-system ESD Withstand Voltage a) Human Body Model, MIL-STD-883, Method 3015 b) Contact Discharge per IEC 61000-4-2 Level 4	Notes 2,4 and 5	±30 ±30			kV kV
V _{CL}	Clamping Voltage during ESD Discharge MIL-STD-883 (Method 3015), 8kV Positive Transients Negative Transients	Notes 2,3,4 and 5		+12 -7		V V
f _C	Cut-off Frequency Z _{SOURCE} =50Ω, Z _{LOAD} =50Ω	R = 100Ω, C = 25pF		70		MHz

Note 1: T_A=25°C unless otherwise specified.

Note 2: ESD applied to input and output pins with respect to GND, one at a time.

Note 3: Clamping voltage is measured at the opposite side of the EMI filter to the ESD pin. For example, if ESD is applied to Pin A1, then clamping voltage is measured at Pin C1.

Note 4: Unused pins are left open

Note 5: These parameters are guaranteed by design and characterization.

Performance Information

Typical Filter Performance (nominal conditions unless specified otherwise, 50 Ohm Environment)

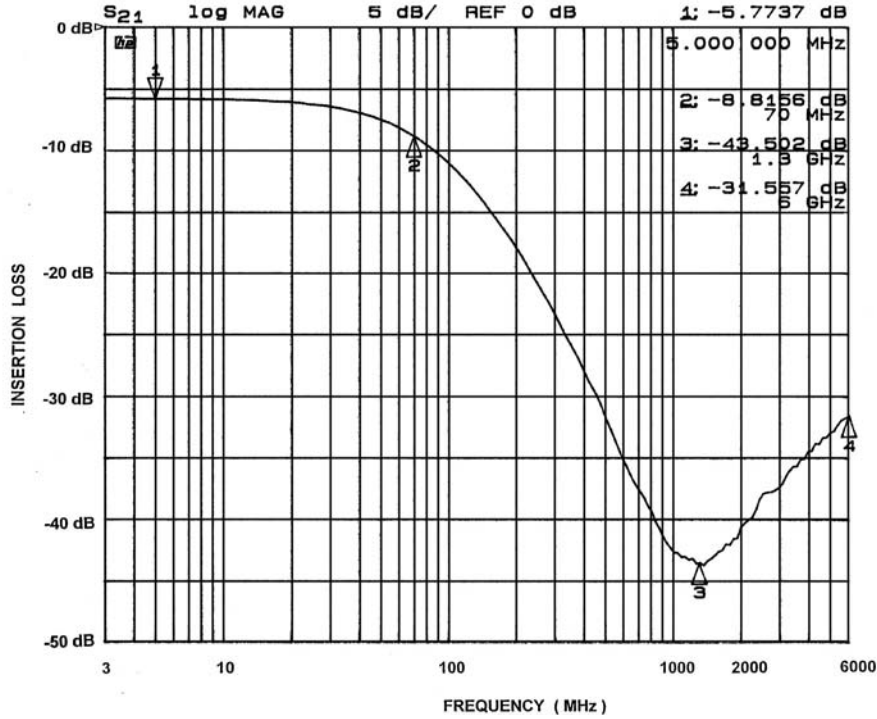

Figure 1. A1-C1 EMI Filter Performance

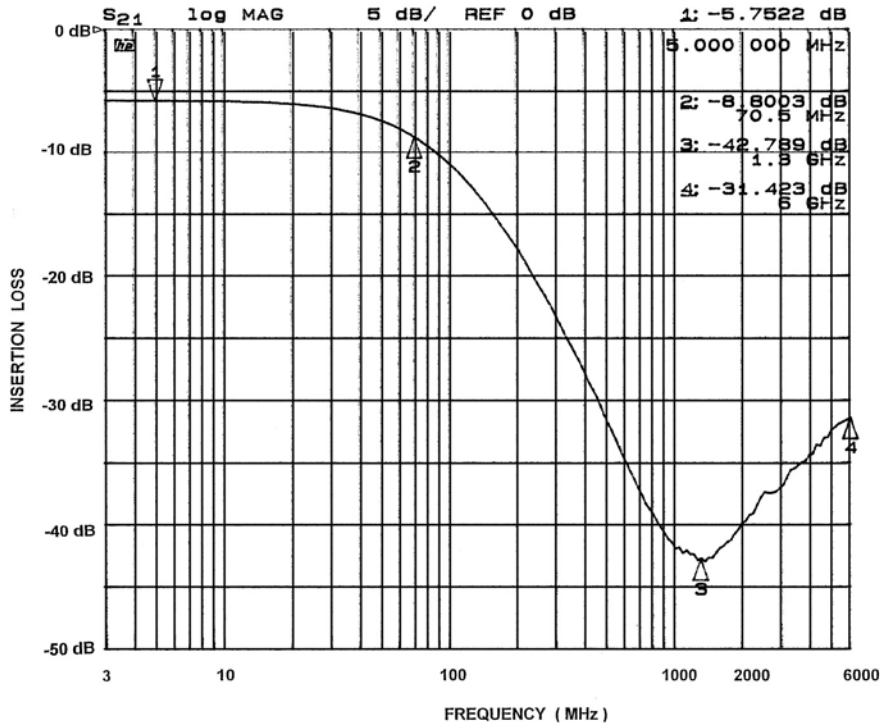

Figure 2. A2-C2 EMI Filter Performance

Performance Information (cont'd)

Typical Filter Performance (nominal conditions unless specified otherwise, 50 Ohm Environment)

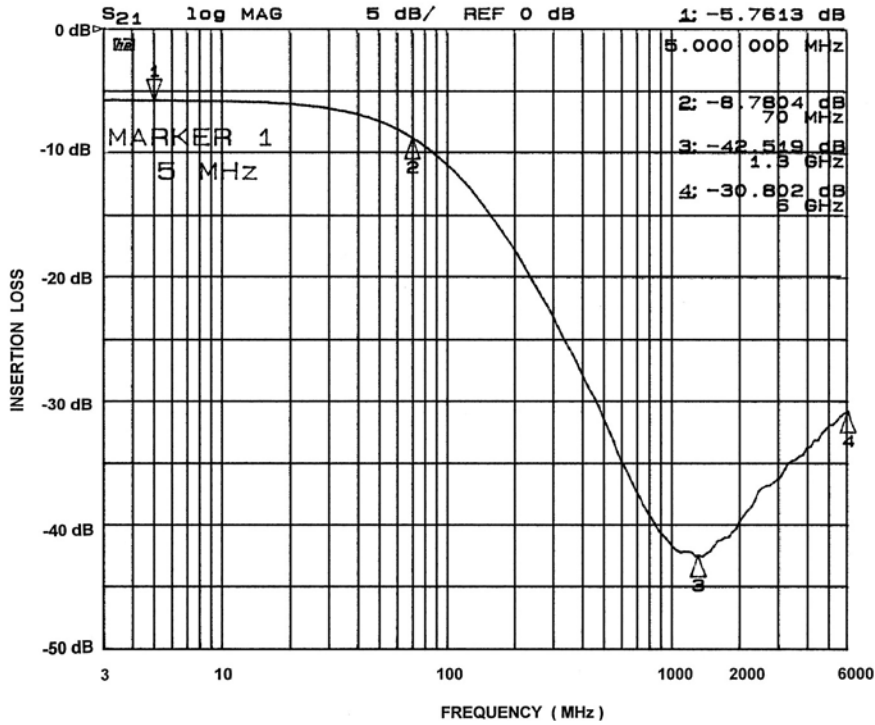

Figure 3. A3-C3 EMI Filter Performance

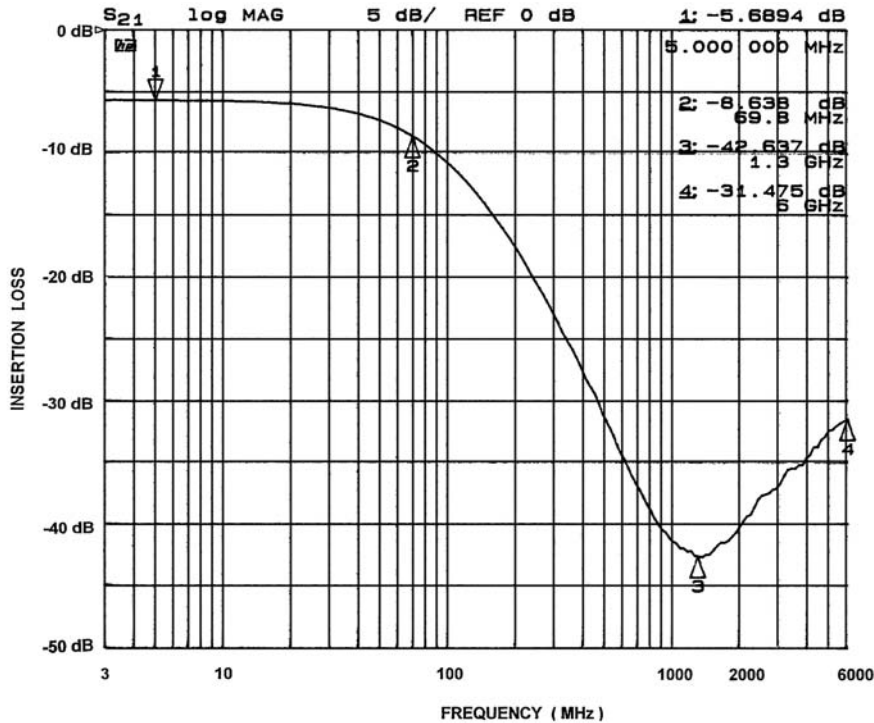

Figure 4. A4-C4 EMI Filter Performance

Performance Information (cont'd)

Typical Filter Performance (nominal conditions unless specified otherwise, 50 Ohm Environment)

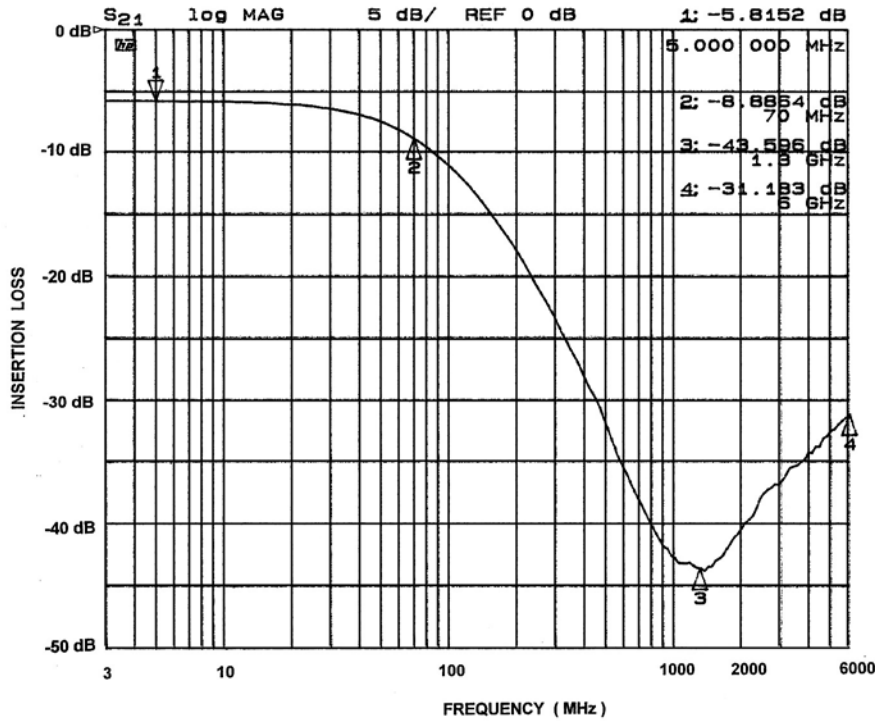

Figure 5. A5-C5 EMI Filter Performance

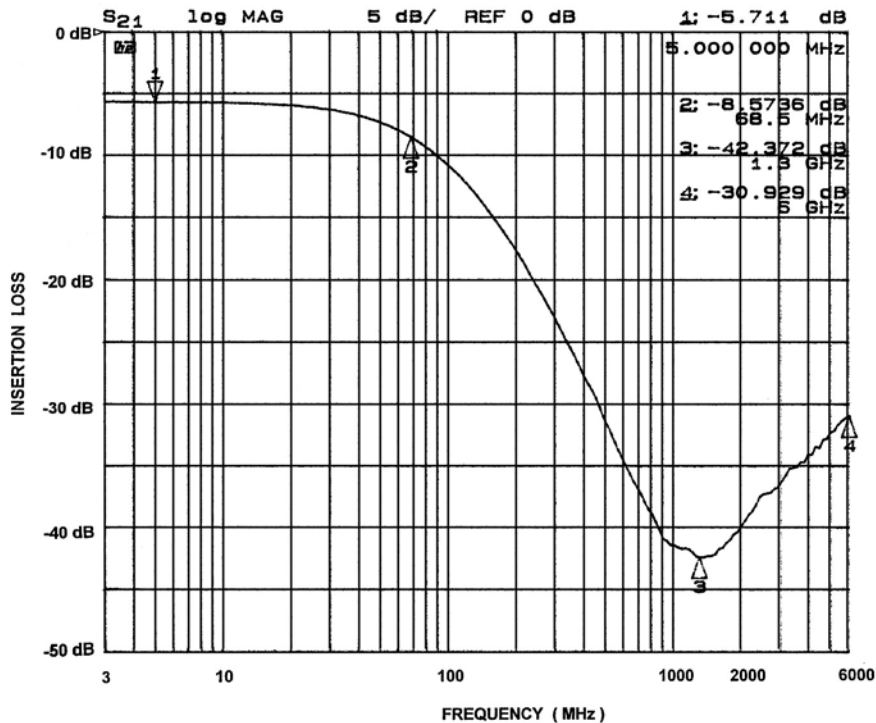

Figure 6. A6-C6 EMI Filter Performance

Performance Information (cont'd)

Typical Filter Performance (nominal conditions unless specified otherwise, 50 Ohm Environment)

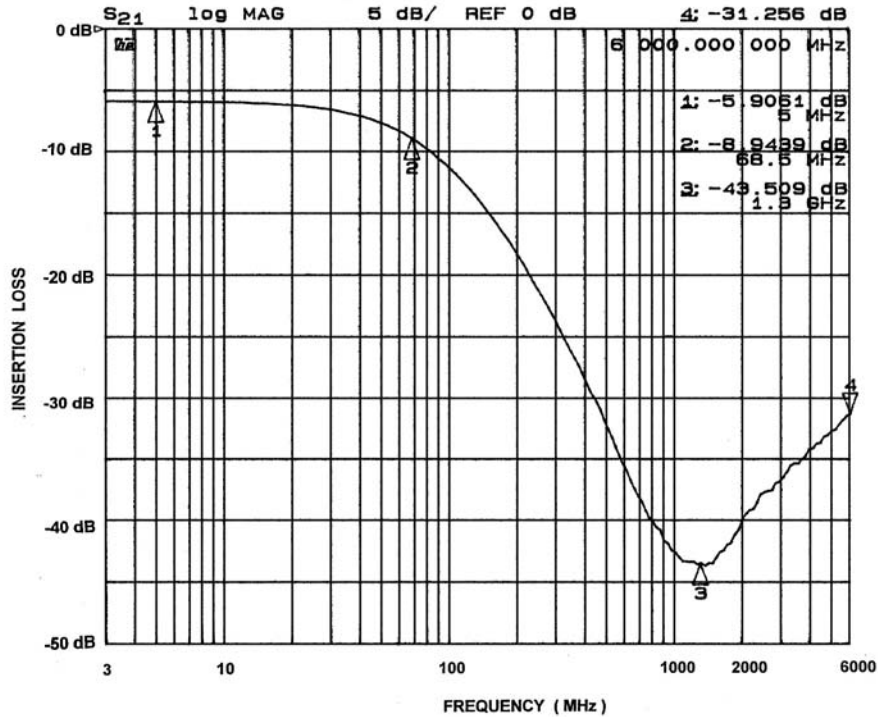

Figure 7. A7-C7 EMI Filter Performance

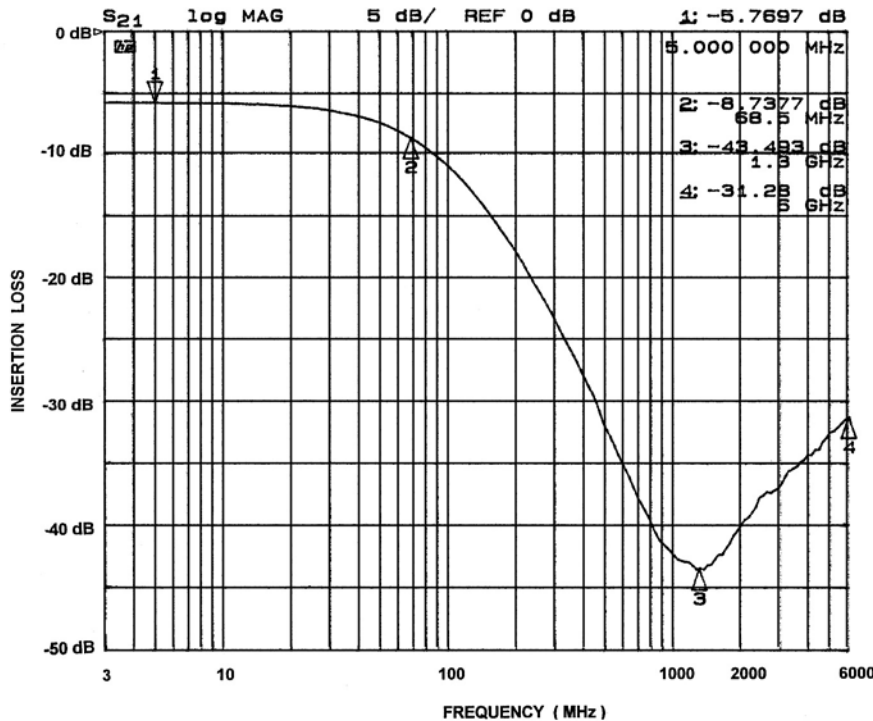

Figure 8. A8-C8 EMI Filter Performance

Performance Information (cont'd)

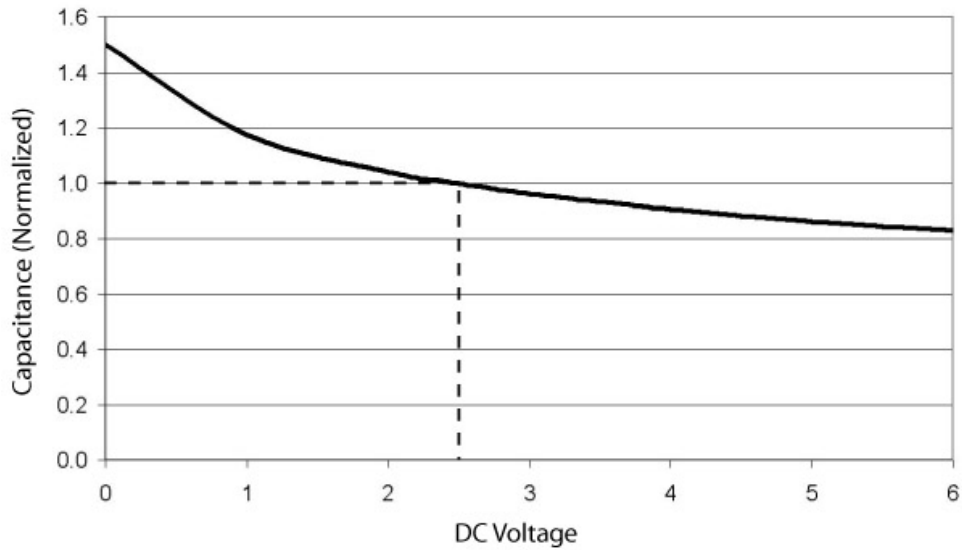

Figure 9. Filter Capacitance vs. Input Voltage over Temperature (normalized to capacitance at 2.5VDC and 25°C)

Application Information

Refer to Application Note AP-217, "The Chip Scale Package", for a detailed description of Chip Scale Packages offered by California Micro Devices.

PRINTED CIRCUIT BOARD RECOMMENDATIONS

PARAMETER	VALUE
Pad Size on PCB	0.275mm
Pad Shape	Round
Pad Definition	Non-Solder Mask defined pads
Solder Mask Opening	0.325mm Round
Solder Stencil Thickness	0.125mm - 0.150mm
Solder Stencil Aperture Opening (laser cut, 5% tapered walls)	0.330mm Round
Solder Flux Ratio	50/50 by volume
Solder Paste Type	No Clean
Pad Protective Finish	OSP (Entek Cu Plus 106A)
Tolerance — Edge To Corner Ball	$\pm 50\mu\text{m}$
Solder Ball Side Coplanarity	$\pm 20\mu\text{m}$
Maximum Dwell Time Above Liquidous	60 seconds
Soldering Maximum Temperature	260°C

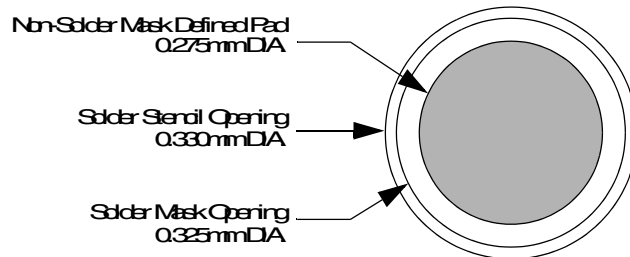

Figure 10. Recommended Non-Solder Mask Defined Pad Illustration

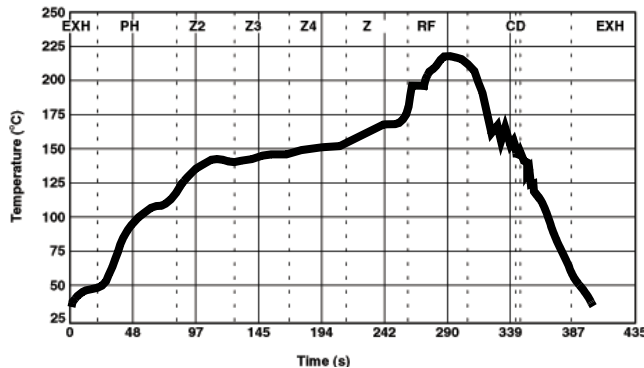

Figure 11. Eutectic (SnPb) Solder Ball Reflow Profile

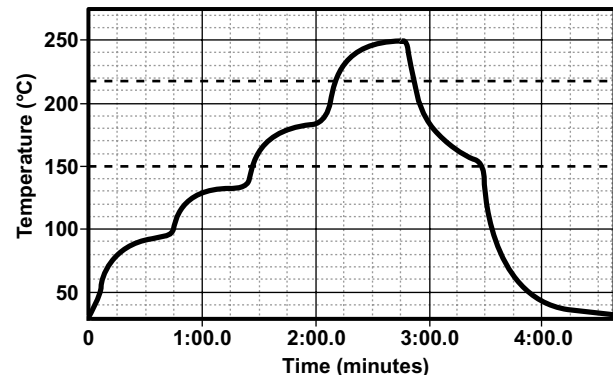

Figure 12. Lead-free (SnAgCu) Solder Ball Reflow Profile

Mechanical Details

CM1405-01 Mechanical Specifications

The package dimensions for the CM1405-01 are presented below.

PACKAGE DIMENSIONS						
Package	Custom CSP					
Bumps	20					
Dim	Millimeters			Inches		
	Min	Nom	Max	Min	Nom	Max
A1	3.955	4.000	4.045	0.1557	0.1575	0.1593
A2	1.413	1.458	1.503	0.0556	0.0574	0.0592
B1	0.495	0.500	0.505	0.0195	0.0197	0.0199
B2	0.245	0.250	0.255	0.0096	0.0098	0.0100
B3	0.430	0.435	0.440	0.0169	0.0171	0.0173
B4	0.430	0.435	0.440	0.0169	0.0171	0.0173
C1	0.200	0.250	0.300	0.0079	0.0098	0.0118
C2	0.244	0.294	0.344	0.0096	0.0116	0.0135
D1	0.561	0.605	0.649	0.0221	0.0238	0.0255
D2	0.355	0.380	0.405	0.0140	0.0150	0.0159
# per tape and reel	3500 pieces					
Controlling dimension: millimeters						

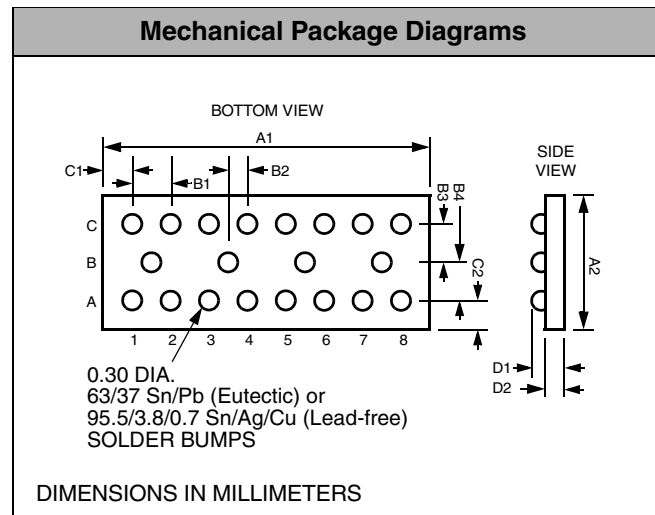

**Package Dimensions for
CM1405-01 Chip Scale Package**

Mechanical Details (cont'd)

CM1405-03 Mechanical Specifications

The package dimensions for the CM1405-03 are presented below.

PACKAGE DIMENSIONS						
Package	Custom CSP					
Bumps	20					
Dim	Millimeters			Inches		
	Min	Nom	Max	Min	Nom	Max
A1	3.955	4.000	4.045	0.1557	0.1575	0.1593
A2	1.413	1.458	1.503	0.0556	0.0574	0.0592
B1	0.495	0.500	0.505	0.0195	0.0197	0.0199
B2	0.245	0.250	0.255	0.0096	0.0098	0.0100
B3	0.430	0.435	0.440	0.0169	0.0171	0.0173
B4	0.430	0.435	0.440	0.0169	0.0171	0.0173
C1	0.200	0.250	0.300	0.0079	0.0098	0.0118
C2	0.244	0.294	0.344	0.0096	0.0116	0.0135
D1	0.600	0.670	0.739	0.0236	0.0264	0.0291
D2	0.394	0.445	0.495	0.0155	0.0175	0.0195
# per tape and reel	3500 pieces					
Controlling dimension: millimeters						

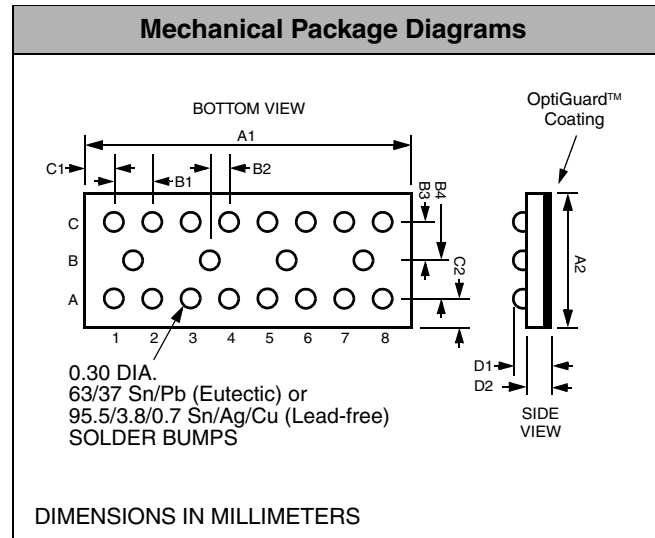

**Package Dimensions for
CM1405-03 Chip Scale Package**

CSP Tape and Reel Specifications

PART NUMBER	CHIP SIZE (mm)	POCKET SIZE (mm) $B_0 \times A_0 \times K_0$	TAPE WIDTH W	REEL DIAMETER	QTY PER REEL	P_0	P_1
CM1405	4.00 X 1.46 X 0.6	4.11 X 1.57 X 0.76	12mm	330mm (13")	3500	4mm	4mm

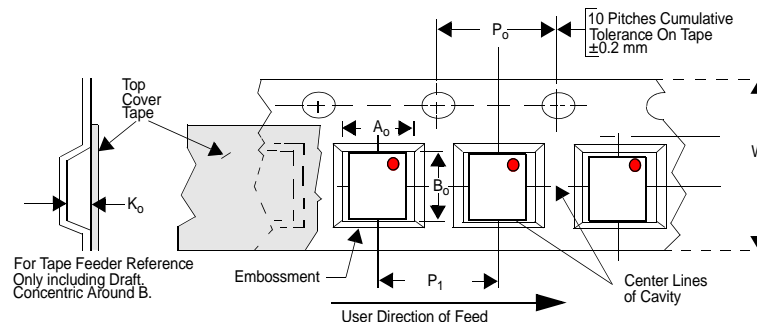

Figure 13. Tape and Reel Mechanical Data