

SEMiX 703GD126HDc

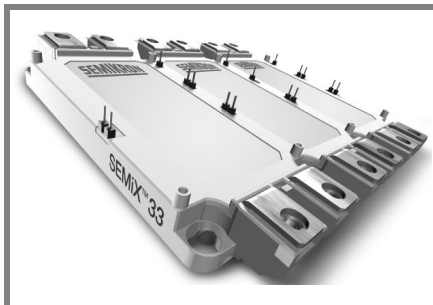

SEMiX® 33c

Trench IGBT Modules

SEMiX 703GD126HDc

Preliminary Data

Features

- Homogeneous Si
- Trench = Trenchgate technology
- $V_{CE(sat)}$ with positive temperature coefficient
- High short circuit capability

Typical Applications

- AC inverter drives
- UPS
- Electronic Welding

Remarks

- Case temperatur limited to $T_C=125^\circ\text{C}$ max.

Absolute Maximum Ratings		$T_{case} = 25^\circ\text{C}$, unless otherwise specified		
Symbol	Conditions	Values		Units
IGBT				
V_{CES}	$T_j = 25^\circ\text{C}$	1200		V
I_C	$T_j = 150^\circ\text{C}$	$T_c = 25^\circ\text{C}$	650	A
		$T_c = 80^\circ\text{C}$	450	A
I_{CRM}	$I_{CRM} = 2 \times I_{Cnom}$	900		A
V_{GES}		± 20		V
t_{psc}	$V_{CC} = 600\text{ V}; V_{GE} \leq 20\text{ V}; T_j = 125^\circ\text{C}$ $V_{CES} < 1200\text{ V}$	10		μs
Inverse Diode				
I_F	$T_j = 150^\circ\text{C}$	$T_c = 25^\circ\text{C}$	560	A
		$T_c = 80^\circ\text{C}$	380	A
I_{FRM}	$I_{FRM} = 2 \times I_{Fnom}$	900		A
I_{FSM}	$t_p = 10\text{ ms}; \text{sin.}$	$T_j = 25^\circ\text{C}$	2900	A
Module				
$I_{t(RMS)}$		600		A
T_{vj}		- 40 ... + 150		$^\circ\text{C}$
T_{stg}		- 40 ... + 125		$^\circ\text{C}$
V_{isol}	AC, 1 min.	4000		V

Characteristics		$T_{case} = 25^\circ\text{C}$, unless otherwise specified			
Symbol	Conditions	min.	typ.	max.	Units
IGBT					
$V_{GE(th)}$	$V_{GE} = V_{CE}, I_C = 18\text{ mA}$	5	5,8	6,5	V
I_{CES}	$V_{GE} = 0\text{ V}, V_{CE} = V_{CES}$			0,3	mA
V_{CE0}		$T_j = 25^\circ\text{C}$	1	1,2	V
		$T_j = 125^\circ\text{C}$	0,9	1,1	V
r_{CE}	$V_{GE} = 15\text{ V}$	$T_j = 25^\circ\text{C}$	1,6	2,1	$\text{m}\Omega$
		$T_j = 125^\circ\text{C}$	2,4	3	$\text{m}\Omega$
$V_{CE(sat)}$	$I_{Cnom} = 450\text{ A}, V_{GE} = 15\text{ V}$	$T_j = 25^\circ\text{C}_{chiplev.}$	1,7	2,15	V
		$T_j = 125^\circ\text{C}_{chiplev.}$	2	2,45	V
C_{ies}	$V_{CE} = 25, V_{GE} = 0\text{ V}$	$f = 1\text{ MHz}$	32,3		nF
C_{oes}			1,69		nF
C_{res}			1,46		nF
Q_G	$V_{GE} = -8 \dots +15\text{V}$		3600		nC
$t_{d(on)}$	$R_{Gon} = 1,6\ \Omega$	$V_{CC} = 600\text{V}$ $I_{Cnom} = 450\text{A}$	310		ns
t_r			60		ns
E_{on}	$R_{Goff} = 1,6\ \Omega$	$T_j = 125^\circ\text{C}$	32		mJ
$t_{d(off)}$			680		ns
t_f			135		ns
E_{off}			68		mJ
$R_{th(j-c)}$	per IGBT		0,061		K/W

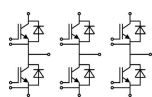

GD

SEMiX 703GD126HDc

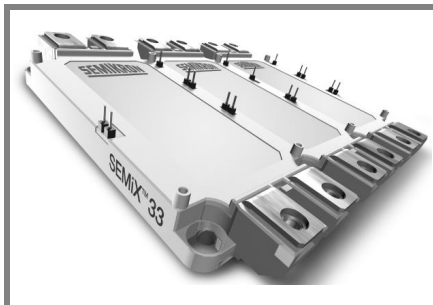

SEMiX® 33c

Trench IGBT Modules

SEMiX 703GD126HDc

Preliminary Data

Features

- Homogeneous Si
- Trench = Trenchgate technology
- $V_{CE(sat)}$ with positive temperature coefficient
- High short circuit capability

Typical Applications

- AC inverter drives
- UPS
- Electronic Welding

Remarks

- Case temperatur limited to $T_C=125^\circ\text{C}$ max.

Characteristics		min.	typ.	max.	Units
Inverse Diode					
$V_F = V_{EC}$	$I_{Fnom} = 450 \text{ A}; V_{GE} = 0 \text{ V}$		1,6	1,8	V
	$T_j = 25^\circ\text{C}_{chiplev.}$				
	$T_j = 125^\circ\text{C}_{chiplev.}$		1,6	1,8	V
V_{F0}			1	1,1	V
	$T_j = 25^\circ\text{C}$				
	$T_j = 125^\circ\text{C}$		0,8	0,9	V
r_F			1,3	1,6	mΩ
	$T_j = 25^\circ\text{C}$				
	$T_j = 125^\circ\text{C}$		1,8	2	mΩ
I_{RRM}	$I_{Fnom} = 450 \text{ A}$		580		A
Q_{rr}	$di/dt = 8500 \text{ A}/\mu\text{s}$		130		μC
E_{rr}	$V_{GE} = -15 \text{ V}; V_{CC} = 600 \text{ V}$		60		mJ
$R_{th(j-c)D}$	per diode			0,11	K/W
Module					
L_{CE}			20		nH
$R_{CC'+EE'}$	res., terminal-chip	$T_{case} = 25^\circ\text{C}$	0,7		mΩ
		$T_{case} = 125^\circ\text{C}$	1		mΩ
$R_{th(c-s)}$	per module		0,014		K/W
M_s	to heat sink (M5)		3	5	Nm
M_t	to terminals (M6)		2,5	5	Nm
w				900	g
Temperature sensor					
R_{100}	$T_c = 100^\circ\text{C}$ ($R_{25} = 5 \text{ k}\Omega$)		0,493±5%		kΩ
$B_{100/125}$	$R(T) = R_{100} \exp[B_{100/125} (1/T - 1/T_{100})]$; $T[\text{K}]; B$		3550±2%		K

This is an electrostatic discharge sensitive device (ESDS), international standard IEC 60747-1, Chapter IX.

This technical information specifies semiconductor devices but promises no characteristics. No warranty or guarantee expressed or implied is made regarding delivery, performance or suitability.

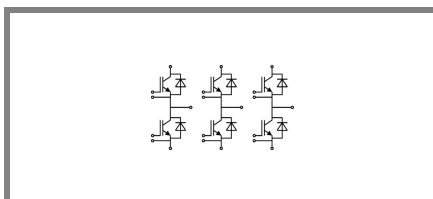

GD

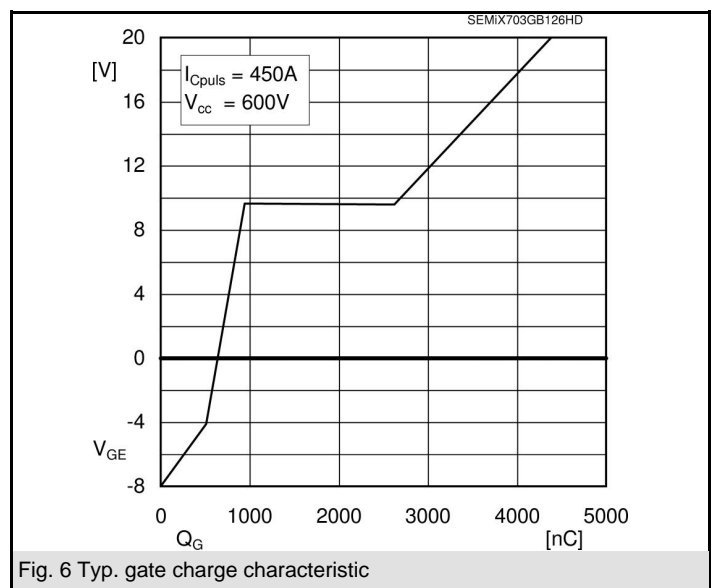
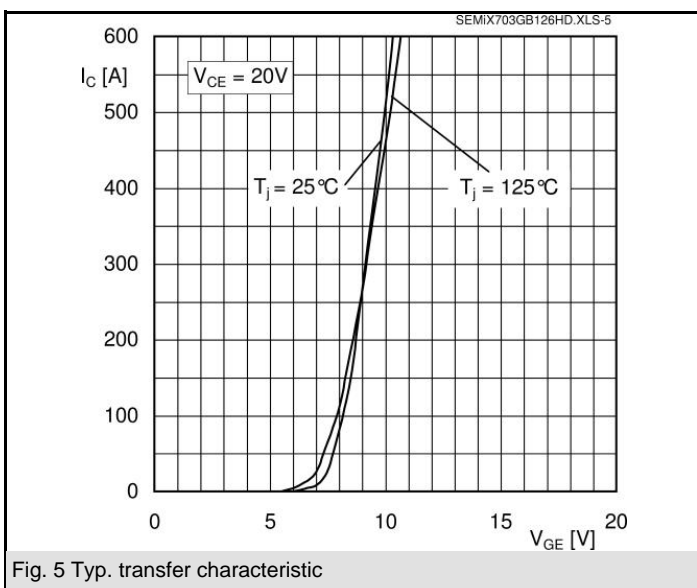
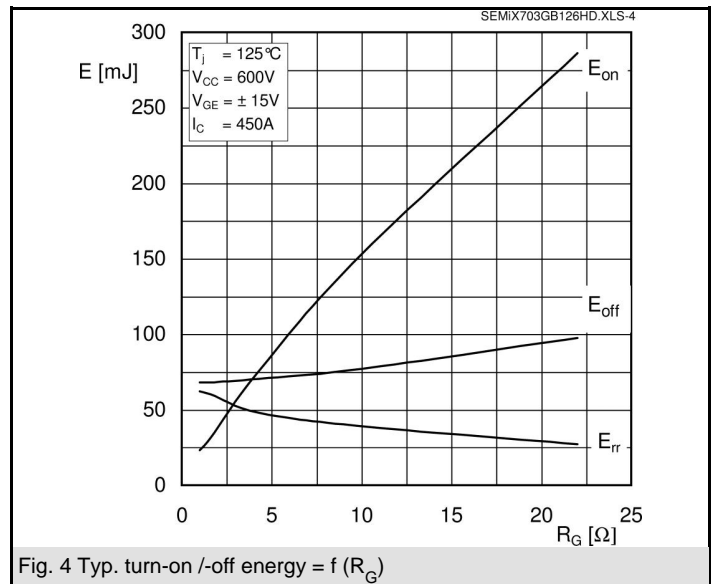
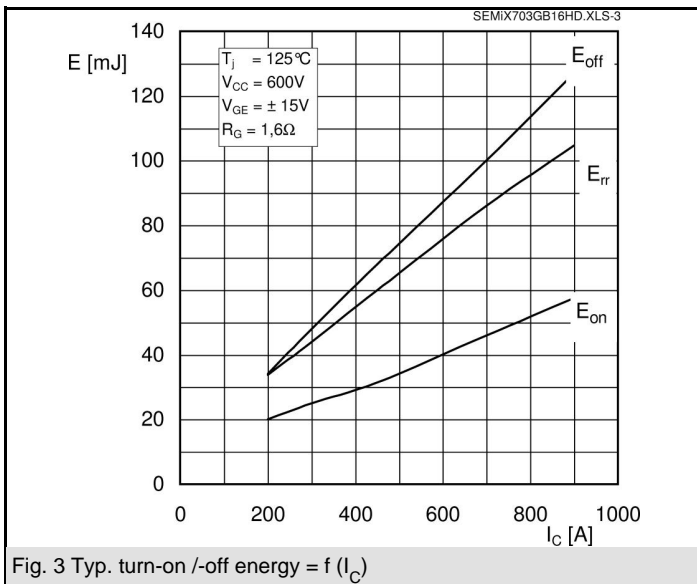
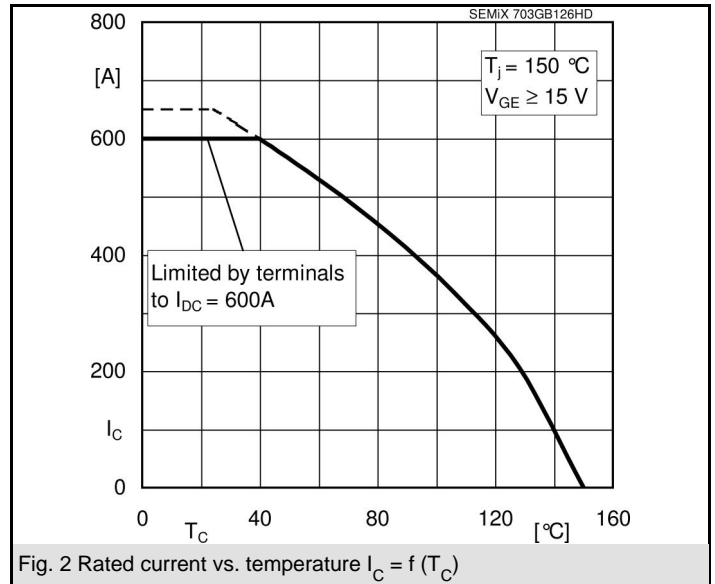
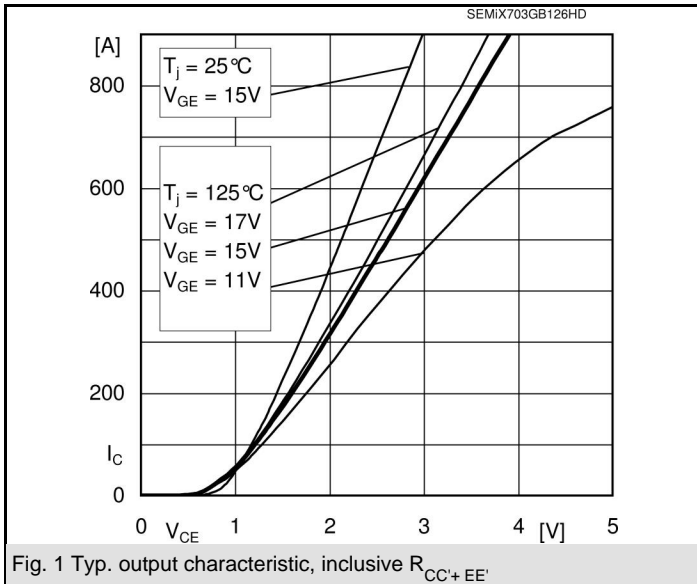

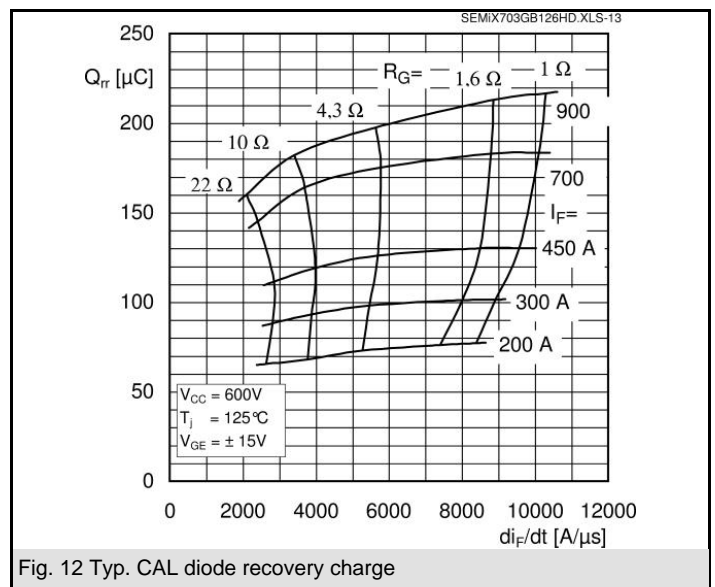
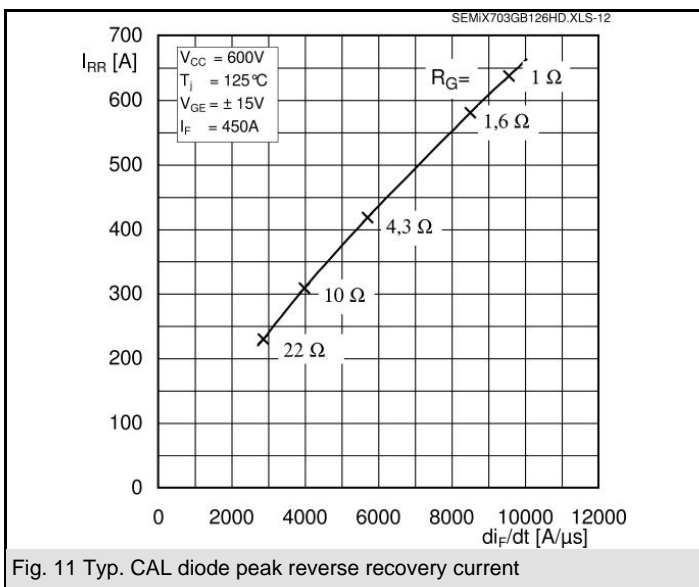
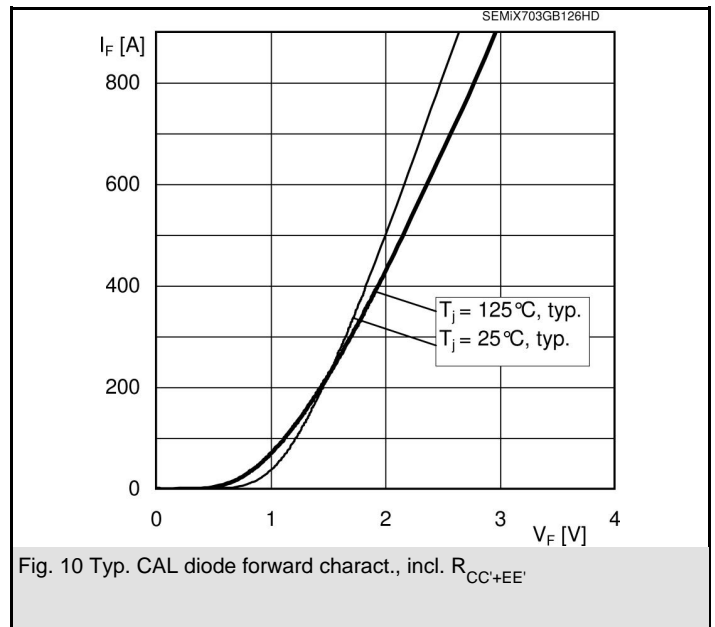
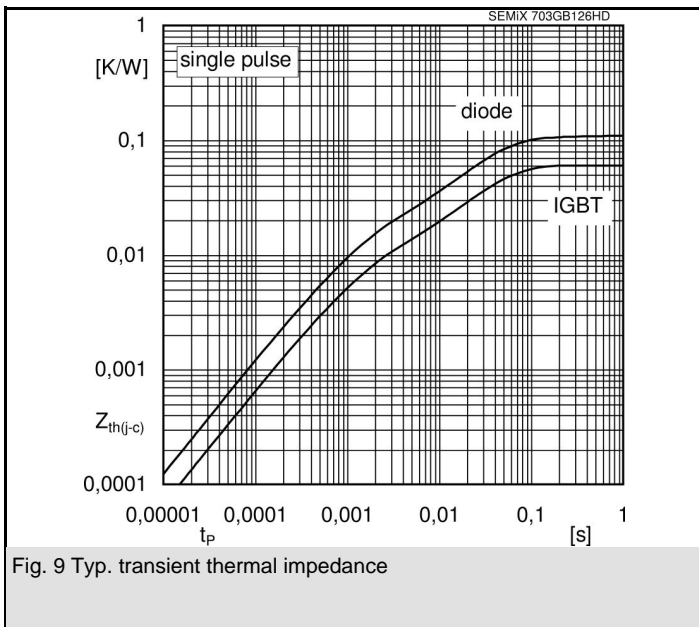
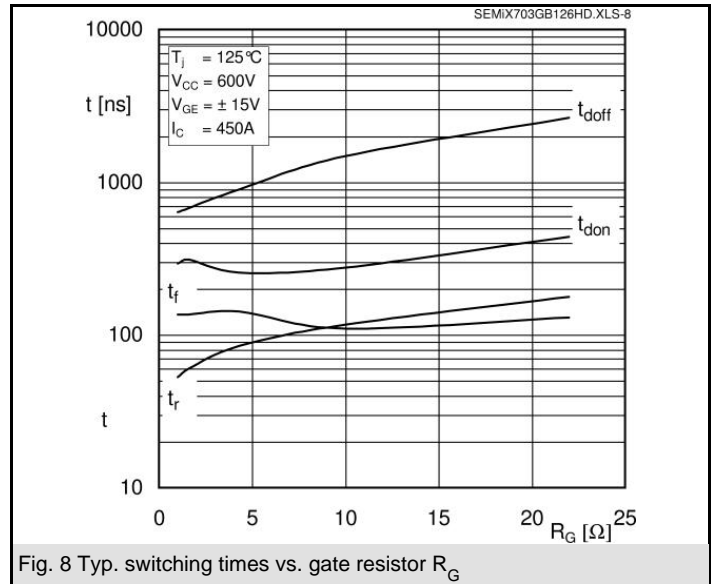
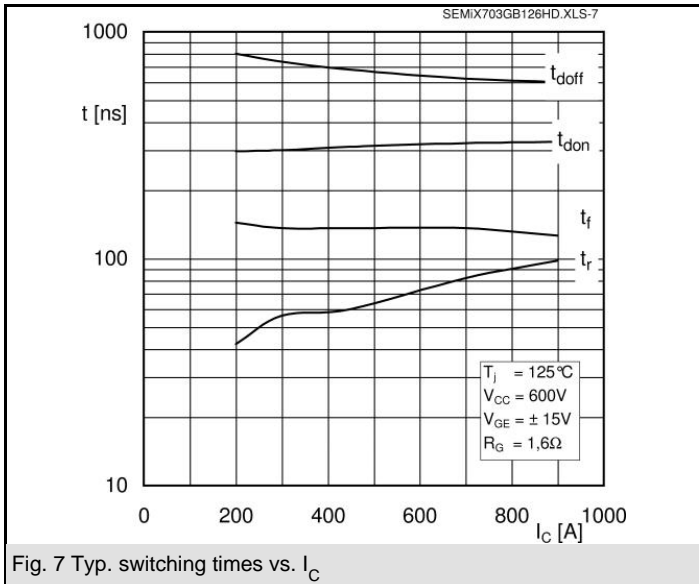

SEMiX 703GD126HDc

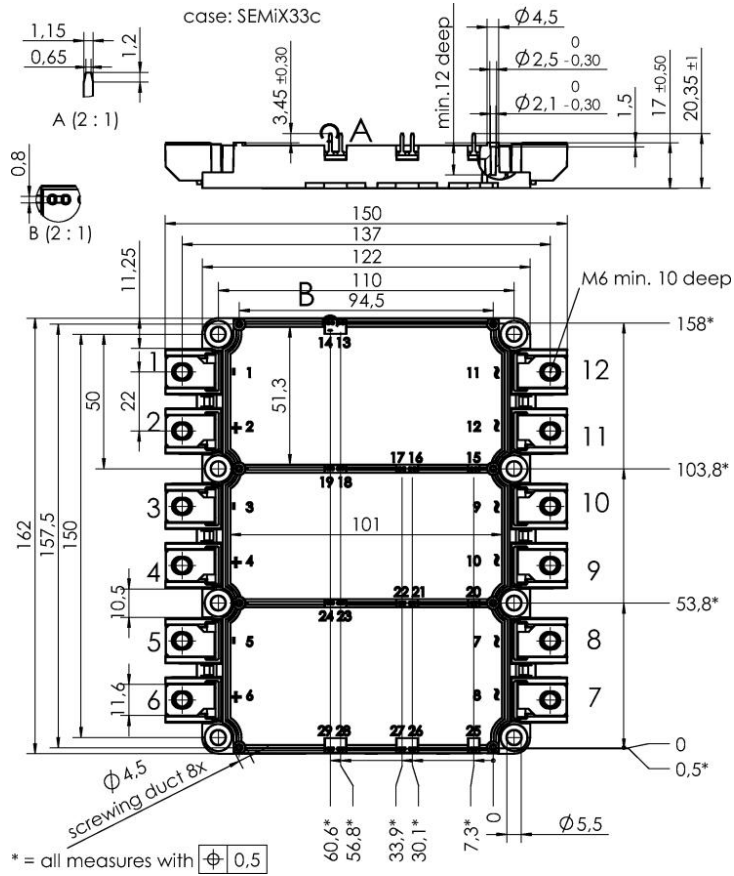

Case SEMiX 33c

