



Technical Data Sheet

0.39" Triple Digit SMD Displays

ELST-405SYGWA/S530-E2

Features

- Packaged in tape and reel for SMT manufacturing.
- Design flexibility(common cathode or anode).
- Categorized for luminous intensity.
- The thickness is thinner than tradition display.
- Pb free
- The product itself will remain within RoHS compliant version



Descriptions

- The SMD type is much smaller than tradition type components, thus enable smaller board size, higher packing density, reduced storage space and finally smaller equipment to be obtained.

Applications

- Suitable for indoor use.
- Audio system.
- Set top box.
- Game machine.
- Channel indicator of TV.

Device Selection Guide

Chip		Face Color
Material	Emitted Color	
AlGaInP	Brilliant Yellow Green	Gray

ELST-405SYGWA/S530-E2

Package Dimensions

Land Pattern(Recommend)

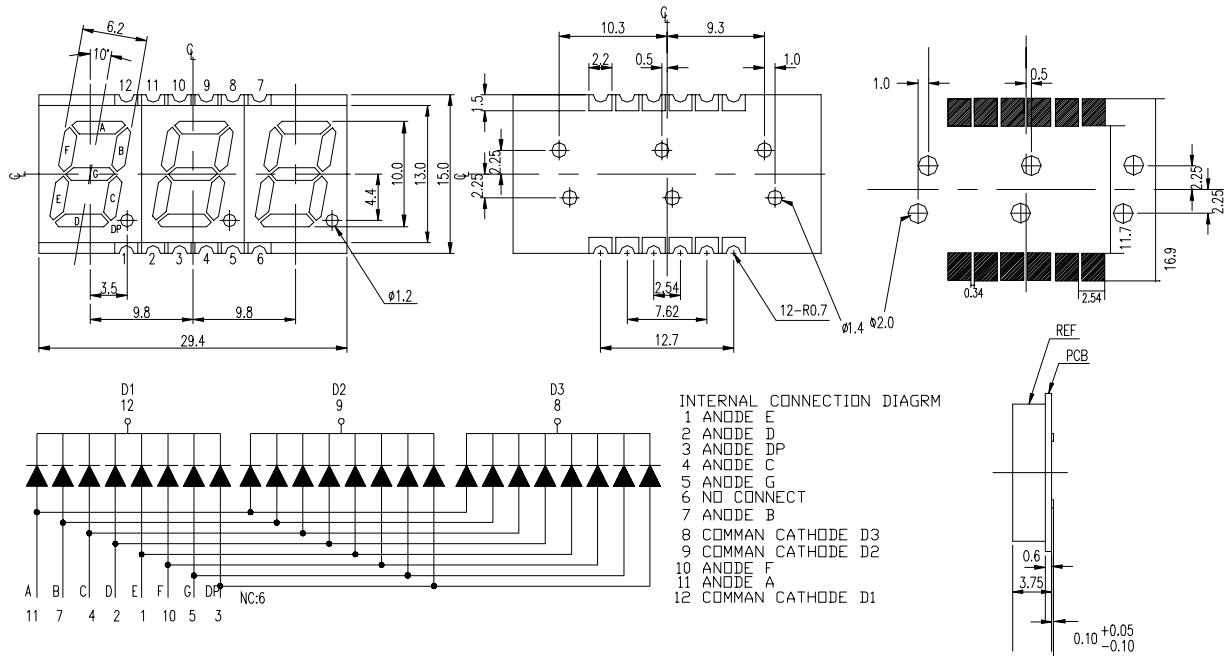

Notes:

- All dimensions are in millimeters, tolerance is 0.25mm unless otherwise noted.
- Above specification may be changed without notice. Supplier will reserve authority on material change for above specification.

Absolute Maximum Ratings (Ta=25°C)

Parameter	Symbol	Rating	Units
Forward Current	I _F	25	mA
Pulse Forward Current *1	I _{FP}	60	mA
Operating Temperature	T _{opr}	-40 ~ +85	°C
Storage Temperature	T _{stg}	-40 ~ +85	°C
Reflow Temperature *2	T _{sol}	260	°C
Electrostatic Discharge	ESD	2000	V
Power Dissipation	P _d	60	mW
Reverse Voltage	V _R	5	V

Notes: *1:I_{FP} Conditions--Pulse Width ≤ 10msec and Duty ≤ 1/10.

*2:Reflow time ≤ 5 seconds.

Electro-Optical Characteristics (Ta=25°C)

Parameter		Symbol	Min.	Typ.	Max.	Units	Condition
Forward Voltage		V _F	--	2.0	2.4	V	I _F =20mA
Reverse Current		I _R	--	--	10	μA	V _R =5V
Luminous Intensity	Per segment	I _V	4.0	9.0	--	mcd	I _F =10mA
	Per decimal point		2.0	3.7	--		
Peak Wavelength		λ _p	--	575	--	nm	I _F =20mA
Dominant Wavelength		λ _d	--	573	--	nm	I _F =20mA
Spectrum Radiation Bandwidth		Δλ	--	20	--	nm	I _F =20mA

Chromaticity Coordinates Specifications for Bin Grading (Unit: mcd)

Rank	Min.	Max.	Rank	Min.	Max.
N	4.0	6.4	T	21.0	34.0
P	5.6	8.9	U	30.0	48.0
Q	7.8	12.5	V	42.0	67.0
R	11.0	17.6	W	59.0	94.0
S	15.0	24.0	---	---	---

Typical Electro-Optical Characteristics Curves

(SYG)

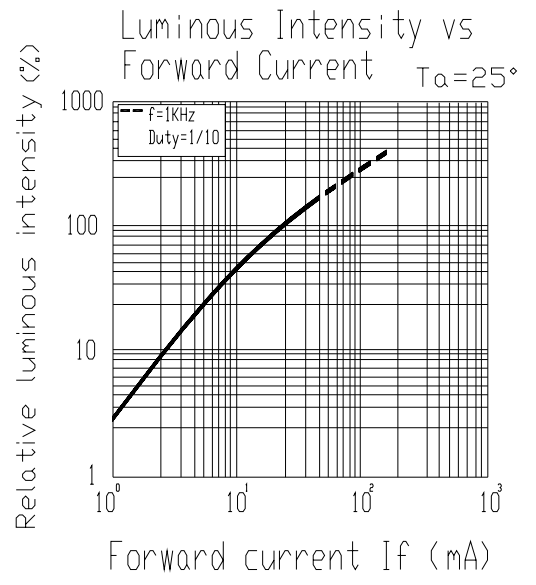
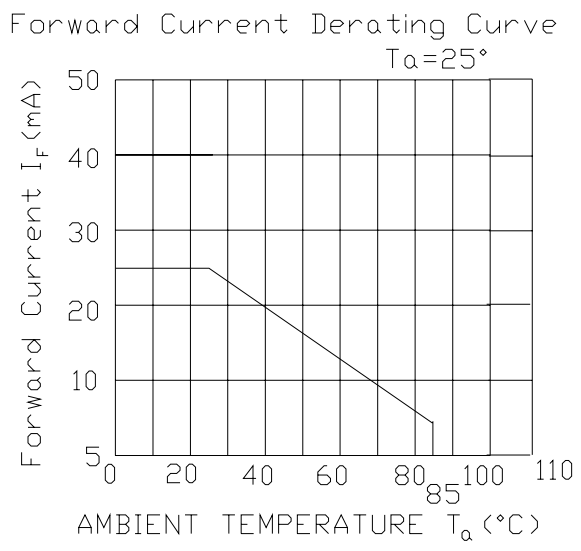
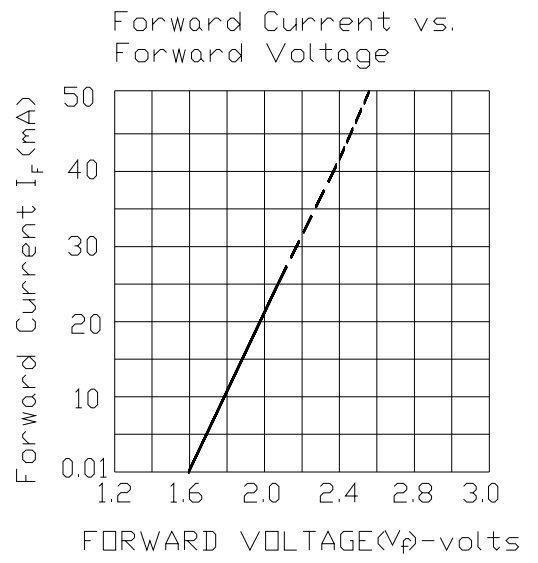
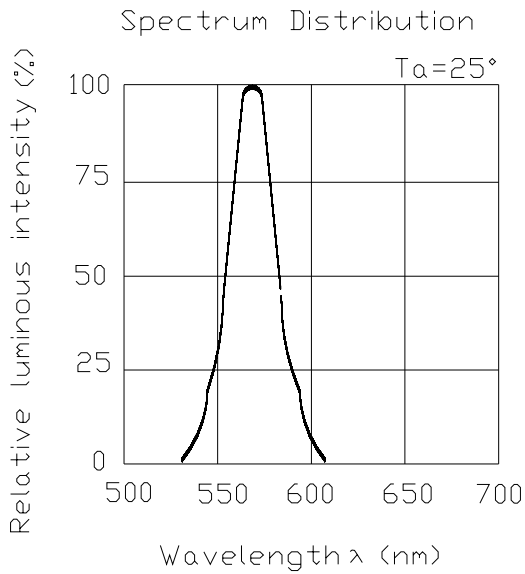

■ **Reflow Temp. / Time :**

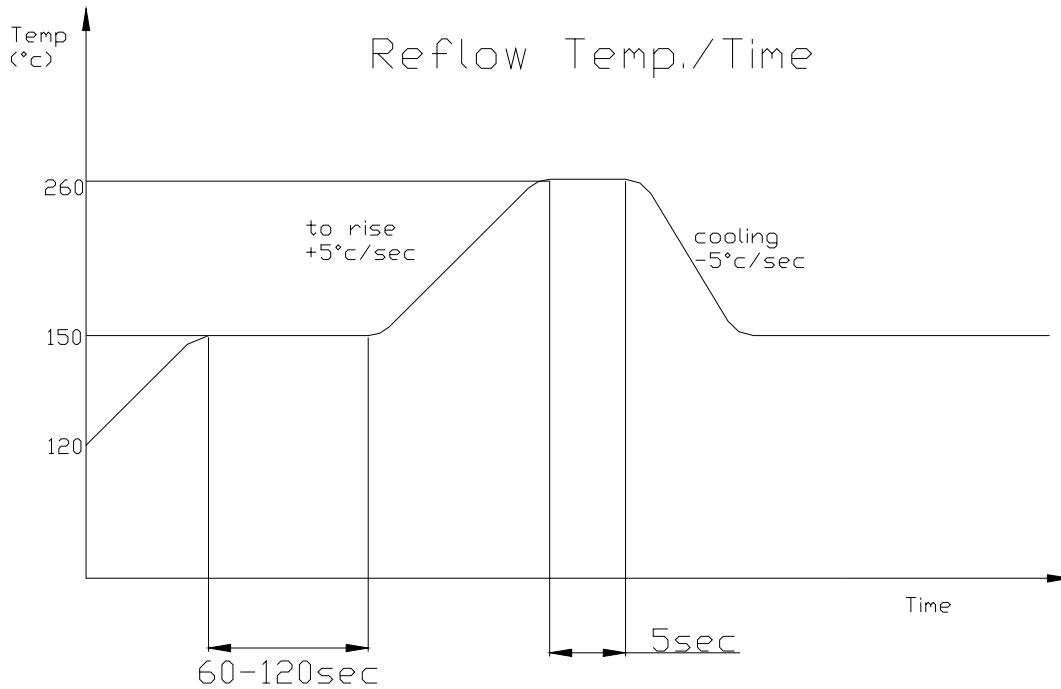

■ **Soldering Iron :**

Basic spec is ≤ 5 sec when 260°C . If temperature is higher, time should be shorter ($+10^{\circ}\text{C} \rightarrow -1\text{sec}$). Power dissipation of iron should be smaller than 15 W , and temperature should be controllable. Surface temperature of the device should be under 230°C .

■ **Rework :**

1. Customer must finish rework within 5 sec under 260°C .
2. The head of iron can not touch copper foil.

ELST-405SYGWA/S530-E2

■ Reliability test items and conditions:

The reliability of products shall be satisfied with items listed below.

Confidence level : 90%

LTPD : 10%

NO	Item	Test Conditions	Test Hours/Cycle	Sample Size	Failure Judgment Criteria	Ac/Re
1	Reflow Soldering	TEMP:260°C±5°C Min. 5 SEC	6 Min	22 PCS	$I_v \leq I_{vt} * 0.5$ or $V_F \geq U$ or $V_F \leq L$	0/1
2	Temperature Cycle	H : +100°C 15min ∩ 5min L : -40°C 15min	300 Cycles	22 PCS		0/1
3	Thermal Shock	H : +100°C 5min ∩ 10 sec L : -10°C 5min	300 Cycles	22 PCS		0/1
4	High Temperature Storage	TEMP:100°C	1000 HRS	22PCS		0/1
5	Low Temperature Storage	TEMP:-40°C	1000 HRS	22 PCS		0/1
6	DC Operating Life	TEMP:25°C If = 10mA	1000 HRS	22 PCS		0/1
7	High Temperature / High Humidity	85°C / 85% RH	1000 HRS	22 PCS		0/1

Note : I_{vt} : The test I_v value of the chip before the reliability test

I_v : The test value of the chip that has completed the reliability test

U : Upper Specification Limit

L : Lower Specification Limit

ELST-405SYGWA/S530-E2

Package Dimensions

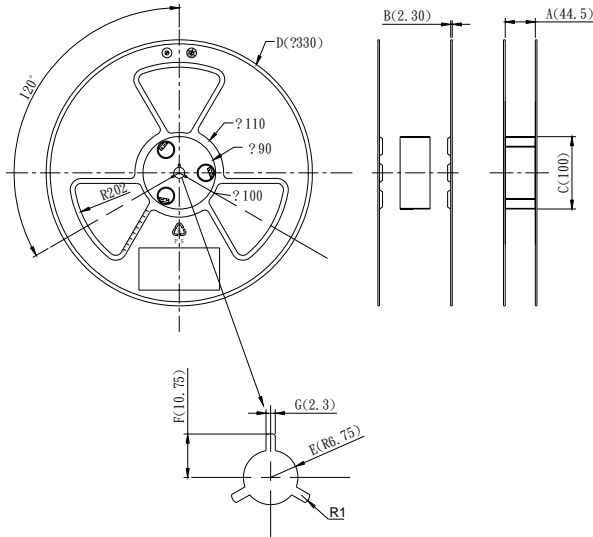

Taping Dimensions

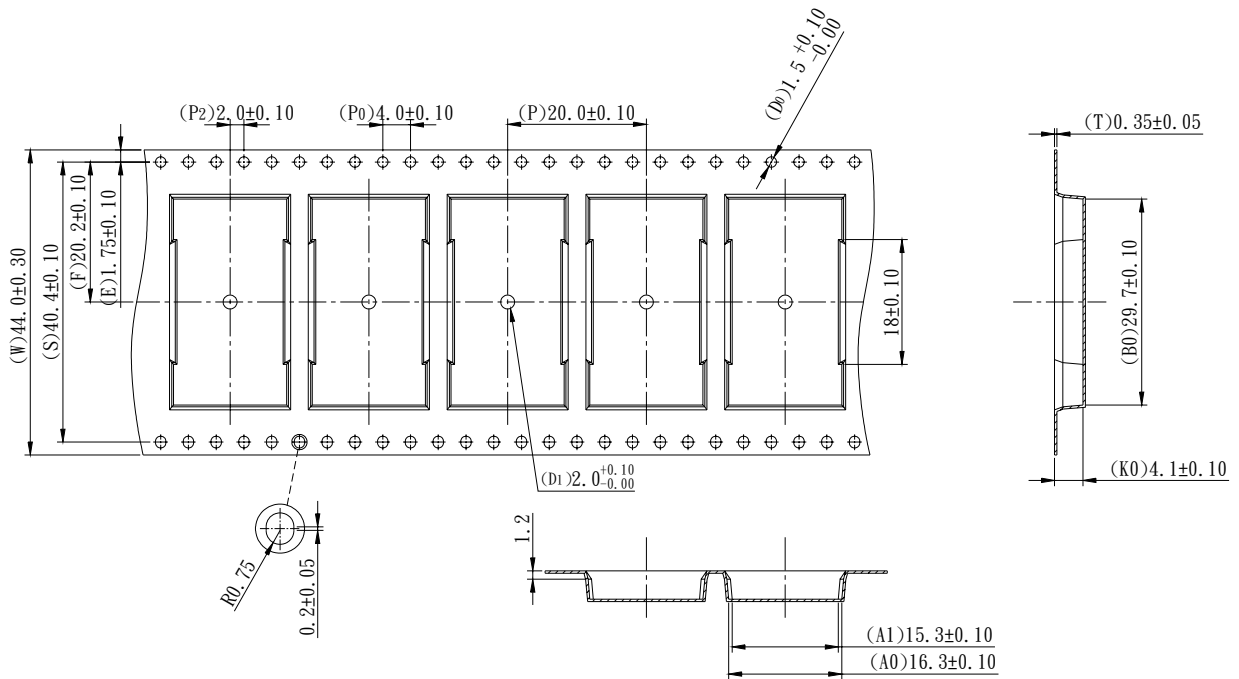



ELST-405SYGWA/S530-E2

Packing Quantity Specification

600PCS/Roll · 1Roll/Small box, 4Small boxes/Box

Label Form Specification



CPN: Customer's Production Number
P/N : Production Number
QTY: Packing Quantity
CAT: Ranks
HUE: Peak Wavelength
REF: Reference
LOT No: Lot Number
DC: Year and weekly

Notes

1. Above specification may be changed without notice. EVERLIGHT will reserve authority on material change for above specification.
2. When using this product, please observe the absolute maximum ratings and the instructions for using outlined in these specification sheets. EVERLIGHT assumes no responsibility for any damage resulting from use of the product which does not comply with the absolute maximum ratings and the instructions included in these specification sheets.
3. These specification sheets include materials protected under copyright of EVERLIGHT corporation. Please don't reproduce or cause anyone to reproduce them without EVERLIGHT's consent.

EVERLIGHT ELECTRONICS CO., LTD.
Office: No 25, Lane 76, Sec 3, Chung Yang Rd,
Tucheng, Taipei 236, Taiwan, R.O.C

Tel: 886-2-2267-2000, 2267-9936
Fax: 886-2267-6244, 2267-6189, 2267-6306
<http://www.everlight.com>