

CIRCUIT DESIGN, INC.

CDP-02

CDP-TX-02 & CDP-RX-02

UHF FM-NARROW BAND SYNTHESIZED RADIO DATA MODULE



Operation Guide

Version 1.1 (February 1996)

**SOUTH PACIFIC ELECTRONICS LTD
P.O. BOX 9417
NADI AIRPORT, FIJI ISLANDS.**

CONTENTS

GENERAL DESCRIPTION & FEATURES	3
CDP-TX-02 transmitter module	4
CDP-RX-02 receiver module	4
OPERATION INSTRUCTIONS.....	6
Supply voltage	6
Data input	6
Data format	7
Channel and frequency setting	7
Outputs	8
Test Set ECB-01 and DCB-01	8
Antennas	8
Satrt up.....	9
SPECIFICATIONS.....	10
CHANNEL AND FREQUENCY SETTING.....	11
BLOCK DIAGRAM	12
DIMENSIONS	13
TEST DATA OF CDP-TX-02	14
TEST DATA OF CDP-RX-02.....	15

GENERAL DESCRIPTION & FEATURES

Features

- 434 MHz UHF band, compatible with European I-ETS 300-220 standard
- Very small compact integrated device with PLL synthesizer and micro controller
- Frequency selection free in 32 channels
- New integrated UHF filter technology
- Registration and charge exempt in Germany, Switzerland, Norway, and Sweden

Applications

- ◆ Radio remote control cranes and machines
- ◆ Radio remote control for garage door controls
- ◆ Security systems
- ◆ Room surveillance
- ◆ Theft protection
- ◆ Telemetry systems for model aircraft

General description

The channel frequency selectable radio data module CDP-02 is a sister of the CDP-01. It consist of CDP-TX-02 (transmitter) and CDP-RX-02 (receiver). It is suitable for various application fields such as wireless data communication, remote control, telemetry or wireless security systems. It is easy to use and integrate into application systems. The CDP-02 has not only kept all the features of the CDP-01 but also has several new features. If you have experience of applying the CDP-01 you can upgrade your products easily by using CDP-02.

The CDP-02 is equipped with a frequency synthesizer system with micro controller. The frequency range of the CDP-02 is from 433.875MHz to 434.650MHz in 32 channels which are selectable by use of a 4 bits switch, and a jumper on the PCB for 2 groups of 16 channels.

The compact size, low operation voltage and frequency selectability of the CDP-02 make it ideal for various applications where its interference rejection and practical distance range is far better than similar RF modules based on wide band SAW-resonator frequency generators.

Standard RS232 serial data and other digital data (TTL level), such as pulse width modulation signals and signals from standard encoder-decoder circuits of the given AF bandwidth, can be transmitted.

Radio licences

The CDP-02 has received radio licence from the following countries. You can use and integrate the CDP-02 in your application and operate it without further registration and free of charges in these countries.

Country	Technical guideline	Approval number	Frequency
Germany	BAPT 222 ZV 125	G750 625G	434 MHz
Switzerland	SR 784.103.12/1.19	BAKOM 96.0107.K.P.	434 MHz
Sweden	I-ETS 300 220	Ue 950190	434 MHz
Norway	I-ETS 300 220	NO 96000105R & 106R	434 MHz

EMC

The CDP-02 was tested at the competent body in Germany and proved to be comply with prl-ETS RES 0908 (June 1995). EMC Type-Examination Certificate for CDP-02 was issued by German BZT. The CE mark is provided on the CDP-02.

CDP-TX-02 transmitter module

The CDP-TX-02 is an UHF FM-narrow band transmitter with PLL synthesizer and micro controller for high frequency stability and channel selectability. Modern SMT technology enable its small size - much smaller than a match box.

The narrow band FM modulation (direct FSK) allows efficient use of the available RF spectrum. Different modules can operate in a 25 KHz channel spacing scheme unlike SAW resonator transmitters which use a very broad band of the frequency spectrum. 32 channels can be easily selected by use of the chip mounted 4 bits switch and a PCB jumper. Please refer to the section on channel plan and frequency setting for details.

The CDP-TX-02 can transmit any 5 Volt digital input data in the specified frequency range. Analog data is digitized by the internal comparator.

About 60mS is needed for PLL lock. 70ms after the transmitter is connected to a power source data can be transmitted without further control or synchronisation.

The transmission is physically done by a flexible Lambda/4 antenna connected to the module. A high gain antenna selected by the customer can also be easily used. The amount of radiated power and directional behavior is influenced by the surrounding of the antenna. Installation in a bigger metal housing with ground connected to the transmitter module housing and the transmitter antenna placed in an upright position outside the metal housing will reduce the antenna impedance and increase the radiated power. For best performance in a user system general rules of radio frequency technology should be taken into consideration.

The same considerations should also be applied to the receiver.

CDP-RX-02 receiver module

The CDP-RX-02 is an UHF receiver for FM-narrow band modulated signals. The receiver design is based on the double Super-heterodyne principle with PLL synthesizer system and micro controller enabling high signal sensitivity, high selectivity, and high frequency stability not achieved by simple SAW resonator receivers or other low cost designs. The channel frequency can be easily selected to match the frequency of the transmitter. The method of frequency selection is the same as CDP-TX-02.

Extensive filtering by an integrated unique SAW filter element enables operation in hazardous areas where interference may be expected. Steadily increasing use of the available frequency spectrum demands the application of narrow band systems for maximum operation reliability and consideration for other users of the ISM band.

The CDP-RX-02 receiver module is designed to match the CDP-TX-02 transmitter module, though signals from other FM-narrow band transmitters can be received as well.

The CDP-RX-02 is designed for mounting on a PCB. It is possible to install the CDP-RX-02 directly in to a system board which is designed for the CDP-RX-01S. A simple wire can be soldered to the antenna input or the antenna can be printed on the PC board. Better performance is attained with commercial antennas for the 434MHz ISM band.

The receiver modules have two different outputs and an RSSI field power output which indicates the power of the incoming RF signal.

The AF output is the analog output from the FM detector circuit. Voltage level, DC-offset and AF noise depend directly on the receiver input signal. This output can be connected to an MSK decoder circuit if a transmitter with additional MSK encoder is used. For simple FSK modulation of digital data, the DATA OUT terminal can be used. It contains a bandpass filter and comparator with digital output (open collector). With additional filtering, the sensitivity of the receiver is increased and the digital output signal can easily be connected to other digital circuits.

To achieve the high signal sensitivity and short receiver response time no internal muting is applied. Valid data signals can be detected by utilizing the RSSI output.

OPERATION INSTRUCTIONS

Please read these instructions before you start using the CDP-02.

The CDP-02 is designed as a module which will be integrated into a user system. It is not a ready-made product for private users. It can be regarded more like a special component for part of an electronic system. Basic knowledge about electronics is needed by the user. Special knowledge about RF technology is helpful, but the most difficult parts are integrated into the modules to enable easy operation. Some additional information is given here:

Supply voltage:

The transmitter and receiver module contain a voltage regulator to guarantee stable performance in the given range of supply voltage.

The design was made for operation with a battery or regulated power source. If the battery voltage drops below the minimum voltage given in the technical specifications, the transmitter output power will drop and the RF oscillator will stop operation. No data can be transmitted in this case. The receiver will continue to work down to a certain voltage but the performance will deteriorate.

If the voltage connected to the Vcc (+) and Ground (-) terminal is above the maximum voltage given in the technical specification the internal voltage regulator will be permanently damaged. The result is an internal short-circuit or disconnection.

To enable a low minimum voltage no internal circuit is used to prevent damage by incorrect polarity. If the transmitter CDP-TX-02 is connected incorrectly, it will be permanently damaged. If a higher supply voltage is available then a simple diode can be inserted in the connection line to the Vcc terminal to prevent damage by incorrect polarity. The diode must be rated for the maximum supply current detailed in the technical specifications.

Modules which have been connected to improper voltage sources should be returned to the dealer for inspection.

Data input:

The data input terminal is connected to a digital transistor compatible input. Data sources of high impedance can be used if the capacitive load of the data input is acceptable.

The voltage of the data signal should be between 0V (Ground level) and Vcc. Because of the internal voltage regulator, it is recommended that the data high level be limited to 5 Volts.

The data can be an analog or digital signal. Analog signals will be converted to a digital 1 or 0 inside the transmitter.

It is not necessary to synchronize the data signal of the transmitter, but the data signal should be fed to the transmitter 70ms after the transmitter power on.

Data format:

The digital data fed to the transmitter is passed through an internal low-pass filter to limit the bandwidth of the digital data. This is needed for an efficient use of the available RF spectrum. At the receiver, a band-pass filter is used to recover the data signal from noise. Together the transmittable signal bandwidth is approximately 10 Hz to 2400 Hz. At the receiver, the signal is converted back into a digital signal for compatibility with succeeding digital systems. The type of digital data signals transmittable is limited by the bandwidth of the system.

DC signal or long intervals of HIGH or LOW bits should be avoided. Succeeding bits can be distorted in their bit length. If the sequence of HIGH or LOW bits is too long it is possible that the logic level of the data output will be changed.

The best countermeasure is to use a digital encoding scheme which guarantees that no low frequency components are included in the data signal. This can be achieved, for example, with the "Manchester" encoding. A digital 1 is coded in a sequence of 10 and a digital 0 is encoded into a sequence of 01. In most cases it is also sufficient to transmit serial data by using start and stop bits of different logical level as can be done with the RS232 format. Each transmitted byte will be preceded by a 0 bit and succeeded by a 1 bit.

The CDP-02 was tested with a number of standard encoder-decoder IC's for simple remote controls. For data speeds in the 300 to 4800 Baud range no trouble should occur.

Because of the wide variety of data formats, data speeds and digital modulations techniques, it is best to set-up a 'worst case' scenario and test the data transmission before the CDP-02 is used in a practical application.

Further advice can be given if the precise format of the data and system requirement is notified to the dealer or directly to Circuit Design, Inc. Your inquiries and comments are welcome and will also help other users.

Channel and Frequency Setting:

By use of chip mounted 4 bits switch and a jumper on the PCB, 32 channels can be easily selected.

The 32 channels are divided to 2 groups: group A and group B. Each group of channel can be selected by solder the jumper ON or OFF. The jumper ON is the state of group A. The jumper OFF is the state of group B. There are 16 channels in each group and can be selected by the 4 bits switch easily. Please refer to the CHANNEL AND FREQUENCY SETTING (Page 11) for channel selection.

Before shipment all the modules are set to the group B and all the 4 bits of switches are set to the state of ON. That means all the modules are set to 433.9 MHz before shipment.

Outputs:

At the receiver side 3 output signals are available.

AF is the direct analog output of the FM receiver.

This signal can be used for checking the receiver and in cases where signals with additional analog modulation are to be received. For example, it can be connected to an MSK decoder.

The DATA output is a digital open collector output. An internal 10KOhm pull-up resistor is applied to enable direct connection to CMOS compatible circuits. For other applications an additional external pull-up resistor should be used.

The receiver has no internal mute circuit to avoid delays and achieve maximum sensitivity. The AF and DATA output will show noise on the output when no signal is received.

The third output is called RSSI. It is an indicator of the received signal strength. It can be used to drive an external mute circuit.

Test Set ECB-01 and DCB-01

The Test Set ECB-01 and DCB-01 were developed to demonstrate and test the CDP-01 and CDP-02 RF data modules. In combination with the CDP-TX-02 and CDP-RX-02 modules, it is a full four command radio remote control that can be used for various practical applications.

The Test Set will save time and effort in planning new developments that incorporate the CDP-02 radio modules as the radio link.

Antennas:

Most important for safe data transmission is a good antenna, and RF grounding, both for the transmitter and the receiver. Without an antenna it is impossible to transmit data over a long distance range.

To comply with the new German BZT requirements, an antenna is not fixed to the transmitter. It is a $\Lambda/4$ wire protected by a plastic cover. The transmitter antenna could be extended or replaced by another antenna or connector.

The receiver has a simple antenna input pin. Any suitable UHF antenna can be connected to it. The easiest way to connect an antenna to the CDP-RX-02 is to solder a 17cm wire directly to the antenna input. If the receiving antenna is installed away from the receiver module, a 50 Ohm Coax antenna wire can be used. The shielding of the antenna wire should be soldered to the case near the antenna input of the CDP-RX-02.

It is possible, but not recommended, to connect the receiver module and the antenna by a connection on a PCB. This will decrease the receiver performance in most cases.

To find the best method of installation for the transmitter and receiver, many things should be considered and tested. It is recommended that the user read specialized literature on antennas and radiation characteristics to gain a better understanding of these fields. A detailed explanation cannot be given here.

In most cases the following basic rules will help you.

- Connect an antenna with 50 Ohm impedance for 434 MHz.
- The easiest construction is a wire of approximately 17cm.
- Place the antenna vertically, straight up or down from the transmitter and receiver module.
- Do not cover the antenna with metal parts.
- The connection of the metal surface of the transmitter and receiver case to a larger metal part (ground plane) will increase radiation and reception efficiency. Such metal part should not be placed near the antenna.
- The best range is achieved if the transmitter and receiver antenna have a direct visual connection. Any object in between the transmitter and receiver antenna, and metallic objects in particular, will decrease the range.
- The transmission is influenced by reflections of the transmitter signal on metallic surfaces. By overlaying the direct and reflected signal with a 180 degree phase shift the signal can almost fade out. Such reflections and fade-outs can result in data drop-outs in mobile applications.
- The human body can have similar effects to metal objects. Pocket transmitters should be taken in the hand and put in a position away from the body and pointed in the direction of the receiver.

Start-up:

After Vcc is connected to the transmitter the VCO and PLL will start-up and, after about 60ms, the output frequency and power will reach the normal value. The same start-up time is needed by the receiver after it is switched on.

Data transmission is not possible, or the data will be distorted, during this start-up period. Therefore the input signal should be fed to the transmitter 70ms after TX power ON.

The transmitter is active as long as the power supply is on. The power should be switched off immediately after the data transmission is finished in order to save valuable battery power and avoid unnecessary use of the RF spectrum.

The receiver does not use the RF spectrum actively and it can remain ON as long as desired.

SPECIFICATIONS

COMMON :

<i>COMMUNICATION FORM</i>	One way
<i>OSCILLATION SYSTEM</i>	PLL controlled VCO
<i>FREQUENCY I-ETS 300 220 EURO TYPE</i>	433.875 MHz to 434.650 MHz
<i>MPT1329 UK TYPE</i>	-
<i>NUMBER OF RF CHANNELS</i>	32 channels
<i>CHANNEL STEP</i>	25 KHz
<i>FREQUENCY STABILITY</i>	±2.5 KHz (-10 to 5°C)
<i>FREQUENCY RESPONSE</i>	10 Hz to 2.4 KHz
<i>BAUD RATE</i>	300 to 4,800 bps
<i>OPERATING TEMPERATURE RANGE</i>	-10 to +60°C
<i>TYPE APPROVAL</i>	Germany, Switzerland, Sweden, EMC,

TRANSMITTER:

<i>TRANSMITTER TYPE</i>	PLL Synthesizer
<i>RF OUTPUT POWER</i>	10 mW +0 /-3 dB at 50 Ohm
<i>TRANSMITTER START UP TIME</i>	60 mS
<i>MODULATION</i>	FM narrow
<i>DATA INPUT LEVEL</i>	3 to 12 V
<i>INPUT SIGNAL</i>	Digital
<i>DEVIATION</i>	2 KHz
<i>SPURIOUS EMISSION</i>	<-60 dBm
<i>ADJACENT CHANNEL POWER</i>	<200 nW
<i>SUPPLY VOLTAGE</i>	3 to 12 V
<i>SUPPLY CURRENT</i>	30 mA
<i>DIMENSIONS</i>	36 x 26 x 10 mm
<i>WEIGHT</i>	11 g

RECEIVER:

<i>RECEIVER TYPE</i>	Double superheterodyne PLL synthesizer
<i>SENSITIVITY</i>	-120 dBm (12 dB / SINAD, CCITT filter)
<i>SELECTIVITY</i>	±7.5 KHz at -6 dB point
<i>DEMODULATION</i>	FM narrow
<i>DISTORTION</i>	<5 % at 1 KHz
<i>S/N RATIO</i>	35 dB overall (AF OUT)
<i>DATA OUTPUT LEVEL</i>	Open collector (digital)
<i>OTHER OUTPUT</i>	RSSI and AF
<i>SUPPLY VOLTAGE</i>	3.6 to 12 V
<i>SUPPLY CURRENT</i>	30 mA
<i>DIMENSIONS</i>	50 x 30 x 9 mm
<i>WEIGHT</i>	18 g

CHANNEL AND FREQUENCY SETTING

Group A

Group B

Channel	Frequency	4bits Switch				Jumper	Channel	Frequency	4bits Switch				Jumper
		1	2	4	8				1	2	4	8	
A1	433.875	ON	ON	ON	ON	ON	B1	433.900	ON	ON	ON	ON	OFF
A2	433.925	ON	ON	ON	OFF	ON	B2	433.950	ON	ON	ON	OFF	OFF
A3	433.975	ON	ON	OFF	ON	ON	B3	434.000	ON	ON	OFF	ON	OFF
A4	434.025	ON	ON	OFF	OFF	ON	B4	434.050	ON	ON	OFF	OFF	OFF
A5	434.075	ON	OFF	ON	ON	ON	B5	434.100	ON	OFF	ON	ON	OFF
A6	434.125	ON	OFF	ON	OFF	ON	B6	434.150	ON	OFF	ON	OFF	OFF
A7	434.175	ON	OFF	OFF	ON	ON	B7	434.200	ON	OFF	OFF	ON	OFF
A8	434.225	ON	OFF	OFF	OFF	ON	B8	434.250	ON	OFF	OFF	OFF	OFF
A9	433.275	OFF	ON	ON	ON	ON	B9	434.300	OFF	ON	ON	ON	OFF
A10	434.325	OFF	ON	ON	OFF	ON	B10	434.350	OFF	ON	ON	OFF	OFF
A11	434.375	OFF	ON	OFF	ON	ON	B11	434.400	OFF	ON	OFF	ON	OFF
A12	434.425	OFF	ON	OFF	OFF	ON	B12	434.450	OFF	ON	OFF	OFF	OFF
A13	434.475	OFF	OFF	ON	ON	ON	B13	434.500	OFF	OFF	ON	ON	OFF
A14	434.525	OFF	OFF	ON	OFF	ON	B14	434.550	OFF	OFF	ON	OFF	OFF
A15	434.575	OFF	OFF	OFF	ON	ON	B15	434.600	OFF	OFF	OFF	ON	OFF
A16	434.625	OFF	OFF	OFF	OFF	ON	B16	434.650	OFF	OFF	OFF	OFF	OFF

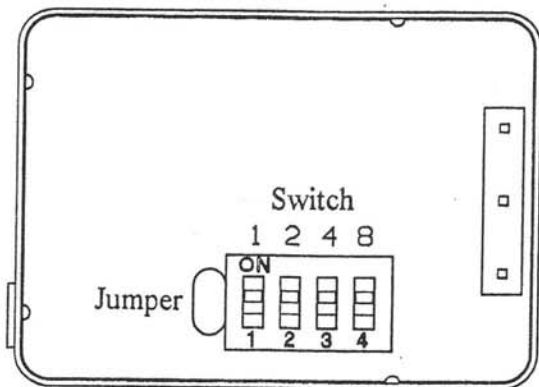

CDP - TX - 02

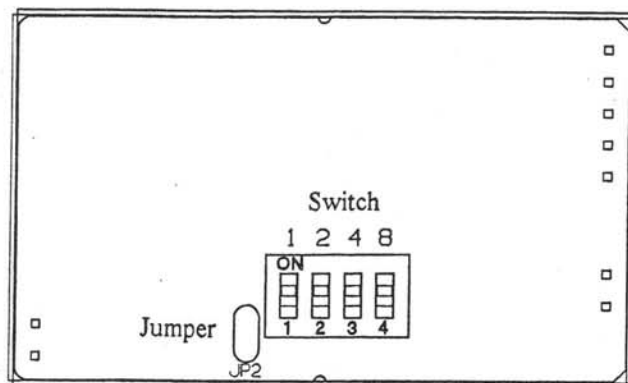

CDP - RX - 02

Frequency Setting Method:

Group A: Jumper ON

Group B: Jumper OFF

Switch: ON = "L"

OFF = "H"

Example:

Set to channel A5 (434.075MHz)

Group A: Jumper ON

Switch: ON, OFF, ON, ON

BLOCK DIAGRAM

CDP-TX-02

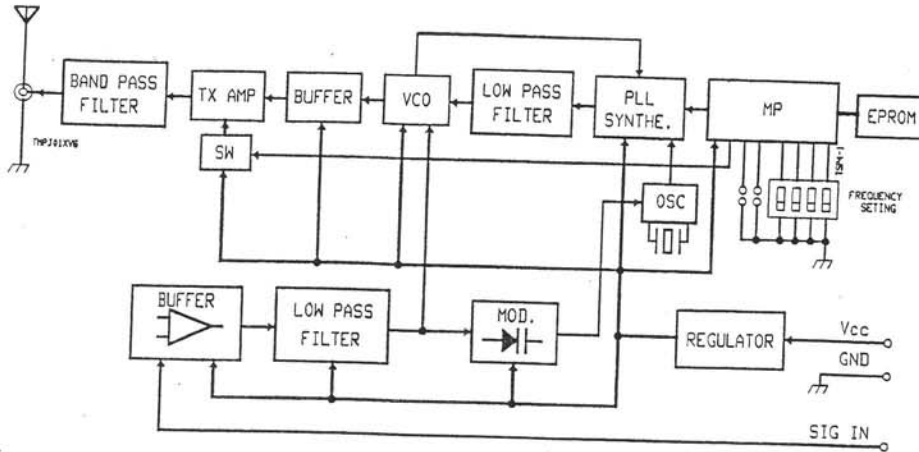

CDP-RX-02

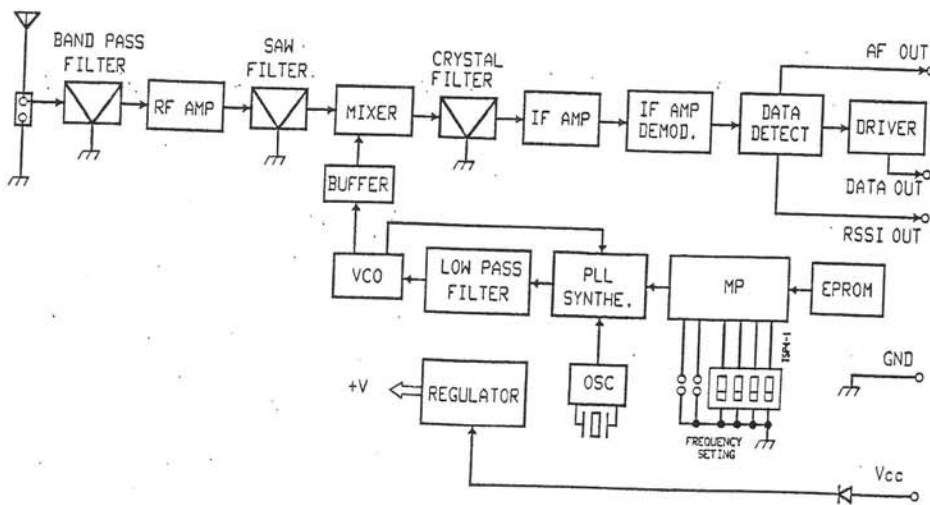

DIMENSIONS (Actual Size)

CDP-TX-02

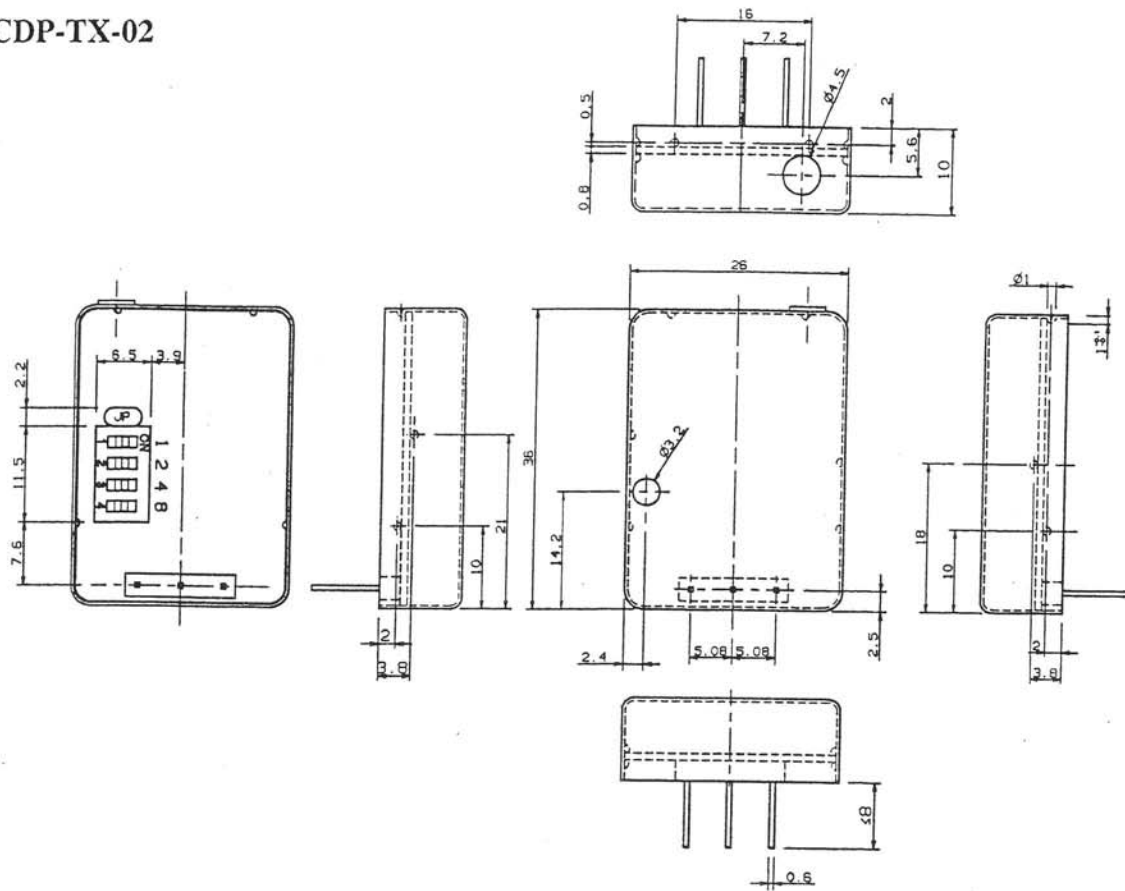

CDP-RX-02

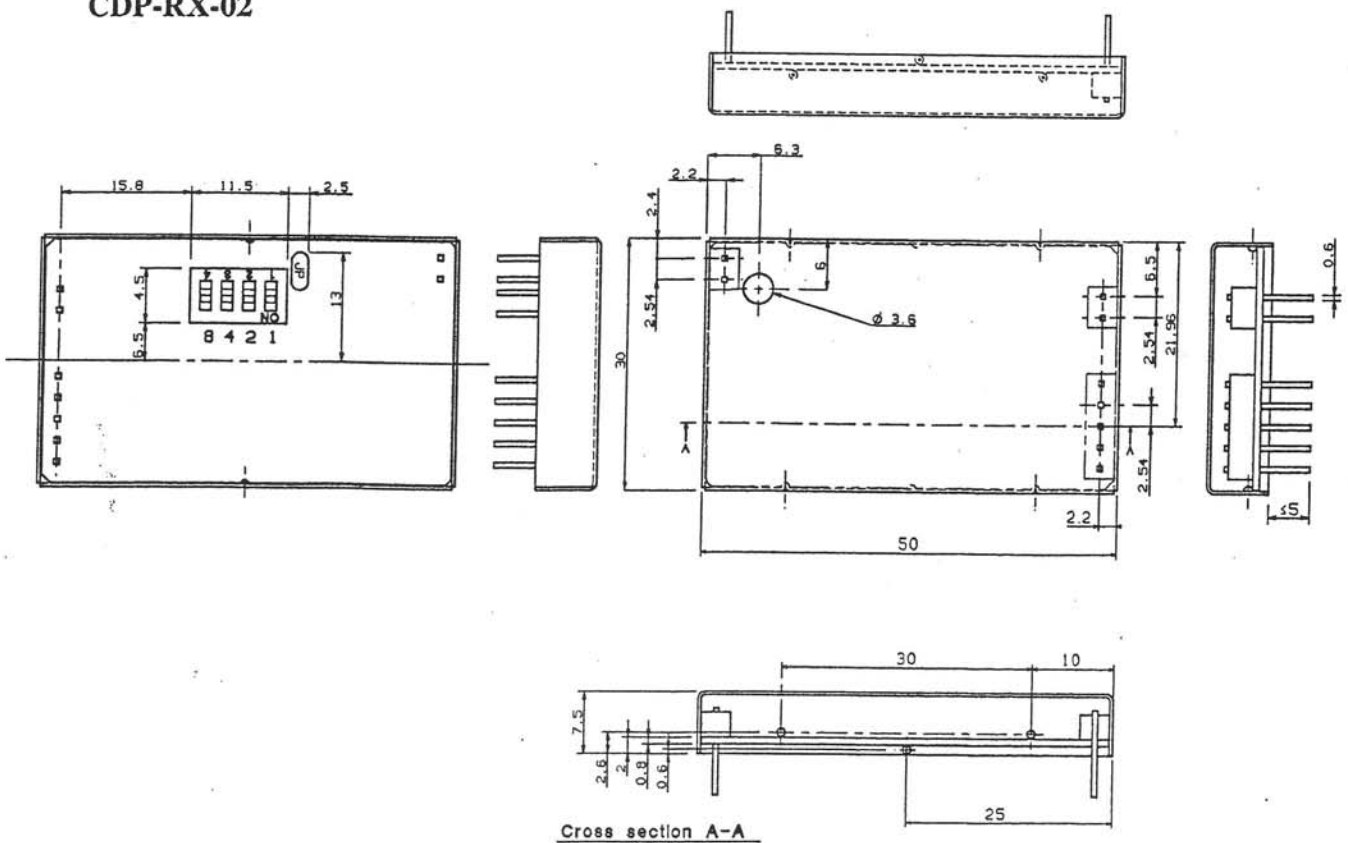

Cross section A-A

TEST DATA OF CDP-TX-02

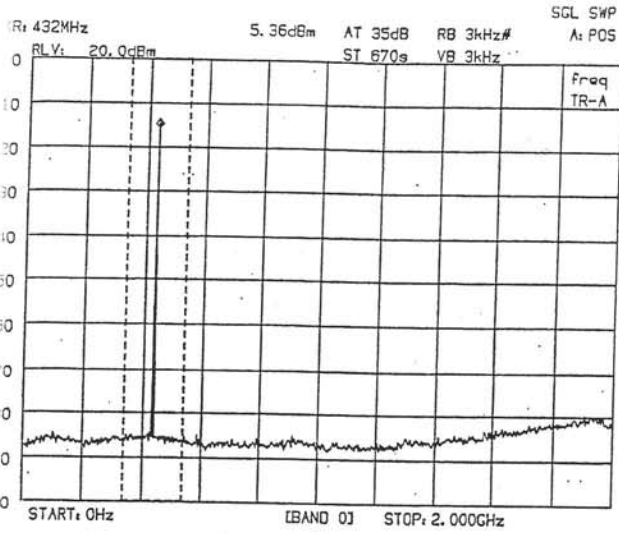

SPURIOUS EMISSION

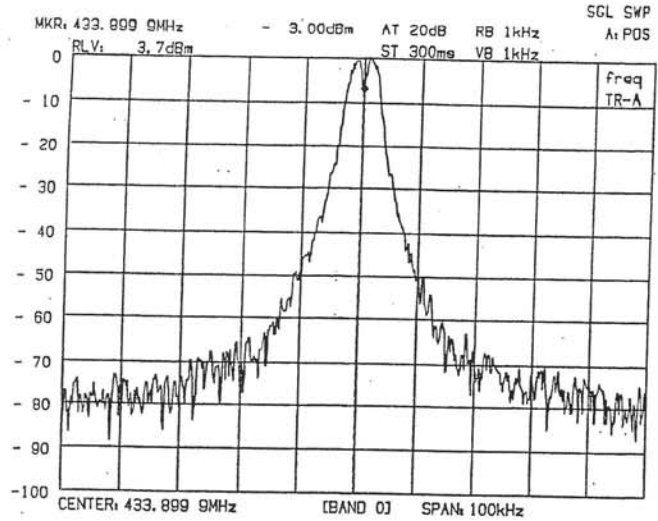

RF-MODULATION

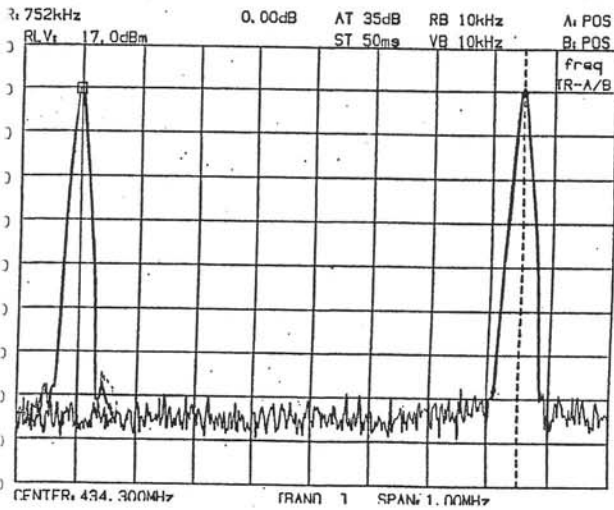

RF BANDWIDTH

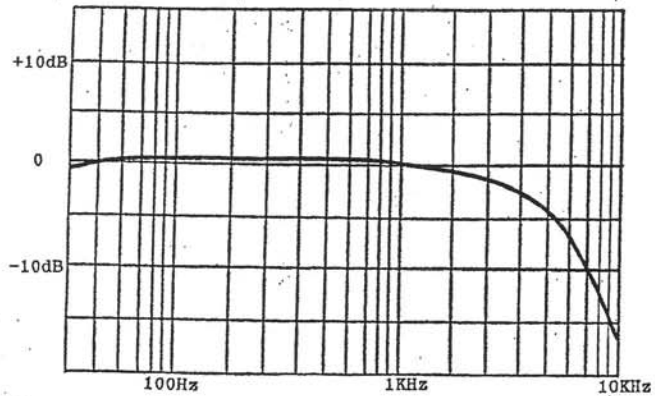

AF BANDWIDTH

TEST DATA OF CDP-RX-02

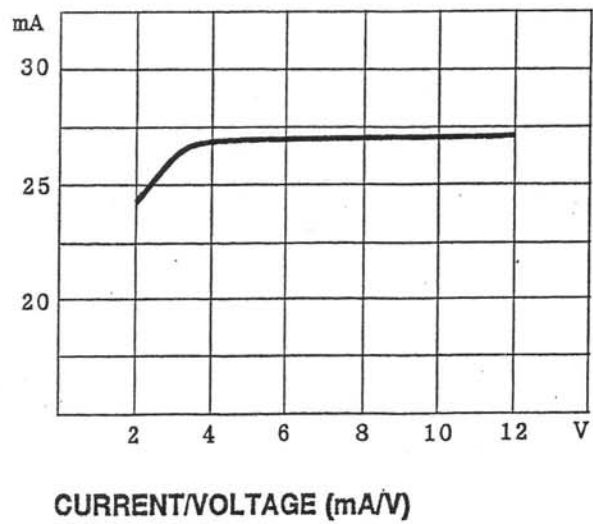
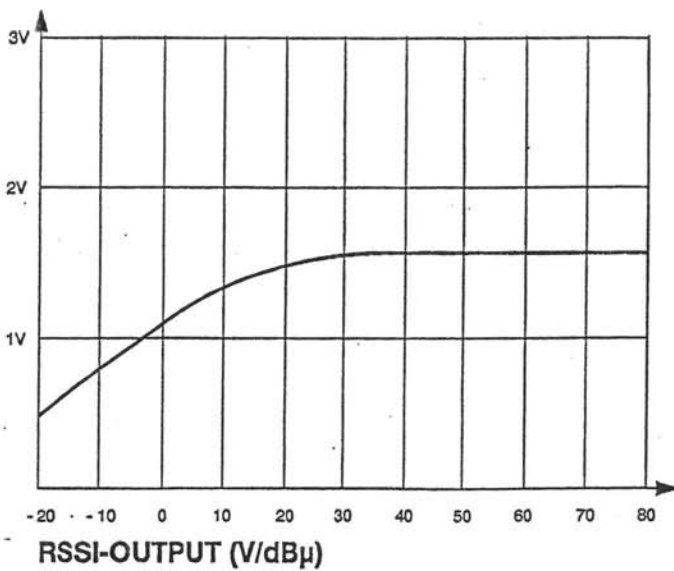
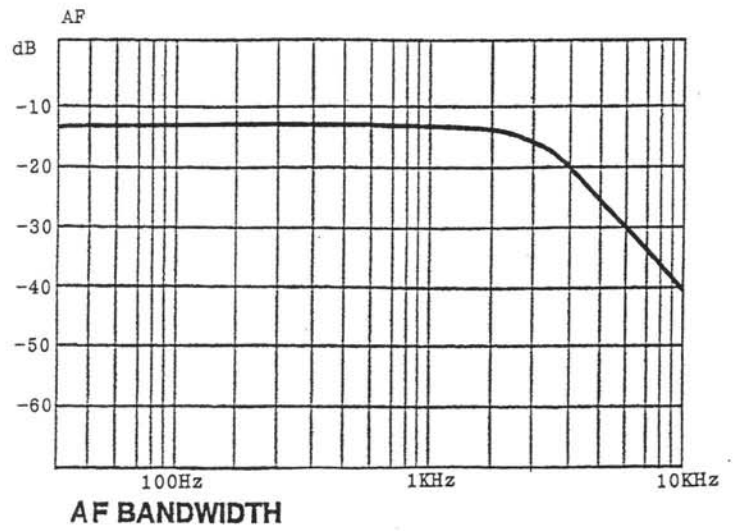
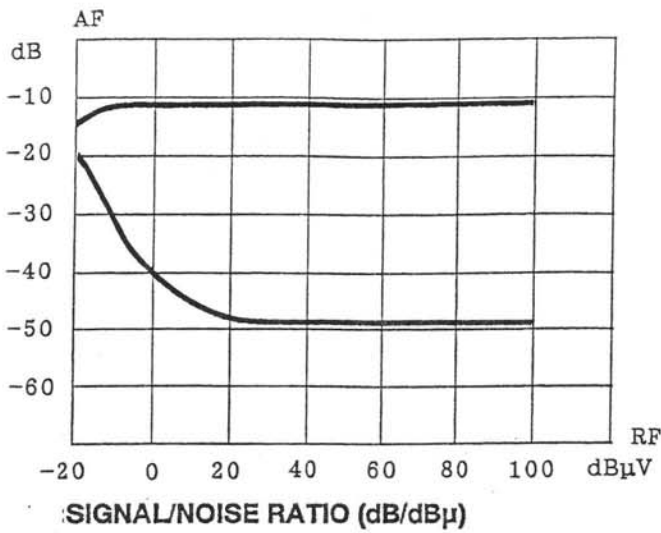

CDP-TX-02A Pin Description

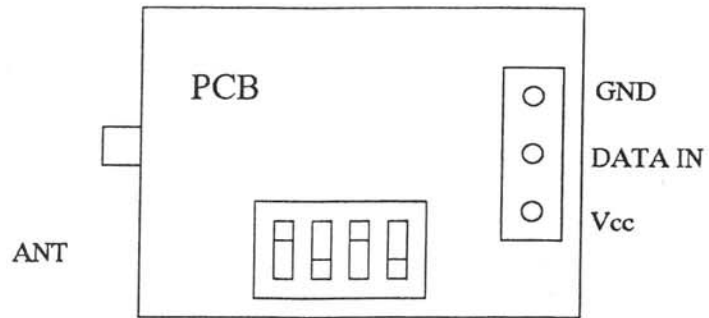

CDP-RX-02A Pin Description

