

Thermal Management Considerations for SuperFlux LEDs

Thermal management is critical in the design of LED signal lamps because temperature affects LED performance and reliability. The following section details the effects of temperature on LEDs. In addition, thermal measurement techniques of LED signal lamps and recommended design practices for proper thermal management are covered.

Table of Contents

Importance of Thermal Management for High-Power LED Assemblies	2
Temperature Induced Effects on LED Light Output	2
Change in Dominant Wavelength (Color) as a Function Of Junction Temperature	2
Temperature-Induced Failures of LEDs	3
Thermal Modeling of LED Assemblies	4
Thermal Resistance of LED Automotive Signal Lamps	4
Junction-to-Ambient Thermal Resistance Measurement Procedure	5
Junction-to-Ambient Thermal Resistance Measurement	5
Estimating Junction-to-Ambient Thermal Resistance	6
Evaluating Junction Temperature and Forward Current	6
Light Output and Forward Current	7
Derating Example Cases	7
Recommended Design Practices for Proper Thermal Management	8
PCB Design	8
<i>Maximum Metallization</i>	8
LED Spacing	9
Lamp Housing Design and Mounting of the LED Array	9
Circuit Design	10
<i>Current Control</i>	10
<i>Power Dissipation</i>	10
<i>"Switching" Power Supplies</i>	11
<i>Ambient Temperature Compensation</i>	11
Appendix 4A	12
Alternate Junction-to-Ambient Thermal Resistance Measurement Procedure	12

Importance of Thermal Management for High-Power LED Assemblies

Temperature Induced Effects on LED Light Output

The junction temperature of the LED affects the device's luminous flux, the color of the device, and its forward voltage. Junction temperature can be affected by the ambient temperature and by self-heating due to electrical power dissipation.

The equation for luminous flux as a function of temperature (°C) is given below:

$$\Phi_v(T_2) = \Phi_v(T_1)e^{-k\Delta T_j}$$

Where:

$\Phi_v(T_1)$ = luminous flux at junction temperature T_1

$\Phi_v(T_2)$ = luminous flux at junction temperature T_2

k = temperature coefficient

ΔT_j = change in junction temperature ($T_2 - T_1$).

Typical temperature coefficients for various high-brightness LEDs are listed in Table 4.1.

The degradation of flux as a function of increasing temperature for a typical red-orange, absorbing-substrate (AS) or transparent-substrate (TS) AlInGaP LED is shown in Figure 4.1. Note, luminous flux has been normalized at 25°C.

This graph shows the profound affect that temperatures within the normal operating guidelines can have on luminous flux. As shown, an increase in the junction temperature of 75°C can cause the level of luminous flux to be reduced to one-half of its room temperature value. From this, it is clear that temperature effects on luminous flux must be accounted for in the design of a LED assembly.

Table 4.1

TEMPERATURE COEFFICIENT FOR HIGH-BRIGHTNESS LED MATERIALS.

LED MATERIAL TYPE	TEMPERATURE COEFFICIENT, k
AS AlInGap, Red-Orange	9.52×10^{-3}
AS AlInGap, Amber	1.11×10^{-2}
TS AlInGap, Red-Orange	9.52×10^{-3}
TS AlInGap, Amber	9.52×10^{-2}

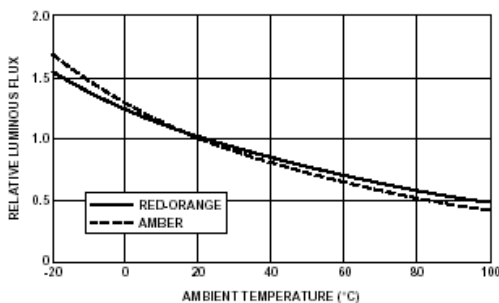

Figure 4.1 Luminous flux versus ambient temperature for a typical red-orange AS/TS AlInGaP LED when operated at a constant current.

Change in Dominant Wave-length (Color) as a Function of Junction Temperature

The junction temperature of LEDs also affects their dominant wavelength, or perceived color.

The equation for dominant wavelength, λ_d , as a function of temperature is:

$$\lambda_d(T_2) = \lambda_d(T_1) + \Delta T_j \cdot 0.1 \left(\frac{\text{nm}}{^\circ\text{C}} \right)$$

Where:

$\lambda_d(T_1)$ = dominant wavelength at junction temperature T_1

$\lambda_d(T_2)$ = dominant wavelength at junction temperature T_2

A rule that is easy to remember is the dominant wavelength will increase one nanometer for every 10°C rise in junction temperature. In most designs of red automotive signal lamps, this change in color is not important because the allowed color range is very large (approximately 90 nm). However, for some amber automotive signal lamps, this color shift can be a concern and should be accounted for where the allowed color ranges are small (approximately 5 to 10 nm depending on the regional specifications).

Temperature-Induced Failures of LEDs

LEDs are typically encapsulated in an optically clear epoxy resin. At a certain elevated temperature, known as the glass transition temperature, T_g , these epoxy resins transform from a rigid, glass-like solid to a rubbery material. A dramatic change in the coefficient of thermal expansion (CTE) is generally associated with the T_g . The T_g is calculated as the midpoint of the temperature range at which this change in CTE occurs, see Figure 4.2.

To avoid catastrophic failure of LED packages, the junction temperature, T_j , should always be kept below the T_g of the epoxy encapsulant. Lumileds specifies a maximum junction temperature, $T_{j(max)}$, which is below the T_g of the epoxy encapsulant used. For SuperFlux LEDs, $T_{j(max)} = 125^\circ\text{C}$. If the $T_{j(max)}$ is exceeded, the CTE of the epoxy encapsulant will permanently and dramatically change. A higher CTE causes the

epoxy encapsulant to expand and contract more during temperature changes. This causes more displacement of the wire bond within the LED package, resulting in a premature wear-out and breakage of the wire. Wire bond breakage results in an open failure.

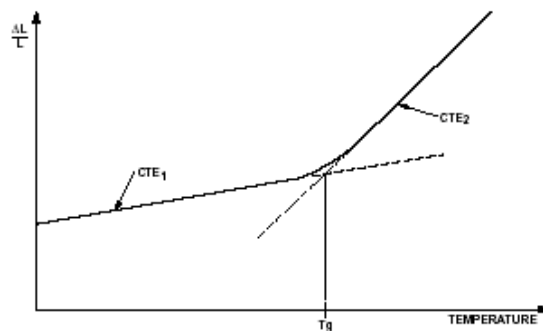

Figure 4.2 Expansion-Temperature relationship for clear, epoxy, LED encapsulants.

Thermal Modeling of LED Assemblies

Thermal Resistance of LED Automotive Signal Lamps

Thermal resistance is associated with the conduction of heat, just as electrical resistance is associated with the conduction of electricity. Defining resistance as the ratio of driving potential to the corresponding transfer rate, thermal resistance for conduction can be defined as shown in the equation below:

$$R_{\theta} = \frac{\Delta T}{q_x}$$

Where:

R_{θ} = thermal resistance between two points

ΔT = temperature difference between those two points

q_x = rate of heat transfer between those two points

The thermal resistance of an LED signal lamp (junction-to-ambient thermal resistance, or $R_{\theta_{ja}}$) is made up of two primary components: the thermal resistance of the LED package (junction-to-pin thermal resistance, or $R_{\theta_{jp}}$) and the thermal resistance of the lamp housing (pin-to-ambient thermal resistance, or $R_{\theta_{pa}}$). These two components of thermal resistance are in a series configuration, therefore:

$$R_{\theta_{jp}} + R_{\theta_{pa}} = R_{\theta_{ja}}$$

(LED emitter) (lamp housing) (LED signal lamp)

This is shown graphically in Figure 4.3.

Assuming all the electrical power is dissipated in the form of heat (approximately 5-to-10% of the power is dissipated optically), the equation for junction-to-pin thermal resistance ($R_{\theta_{jp}}$) of an LED can be written in the form of the equation below:

Where:

P = the total electrical power into the LED ($I_f \cdot V_f$)

For LED lamp assemblies, the equation for junction-to-ambient thermal resistance, $R_{\theta_{ja}}$, of an individual LED within the assembly can be written as:

$$R_{\theta_{ja}} = \frac{T_j - T_a}{P}$$

$$= \frac{(\Delta T_j + T_a) - T_a}{P} = \frac{\Delta T_j}{P}$$

Where $T_j = \Delta T_j + T_a$.

As can be seen from this equation, in order to determine $R_{\theta_{ja}}$ of an LED within a lamp assembly, the rise in junction temperature, and the electrical power into the device must be determined. The electrical power into the LED under test can easily be determined by multiplying its forward current and forward voltage. The rise in junction temperature can be determined by measuring the change in forward voltage of the LED under test.

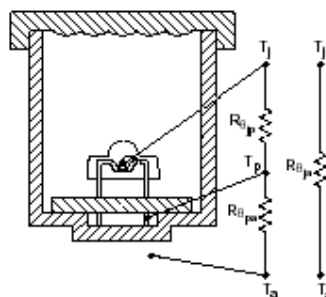

Figure 4.3 Graphic representation of the components of thermal resistance.

Junction-to-Ambient Thermal Resistance Measurement Procedure

A simple method for measuring the $R\theta_{ja}$ of a lamp assembly is possible by assuming the $R\theta_{jp}$ of the device under test (DUT) is of a typical value. By making this assumption, only the pin-to-ambient thermal resistance, $R\theta_{pa}$, needs to be measured to calculate the $R\theta_{ja}$ of the lamp ($R\theta_{ja} = R\theta_{jp} + R\theta_{pa}$). This simplified procedure for measuring $R\theta_{ja}$ is described below:

Step 1: Assume the $R\theta_{jp}$ of the LED emitter is that shown in the data sheet (typical $R\theta_{ja}$ for HPWA-xx00 = 155 °C/W, and for HPWT-xx00 = 125 °C/W).

Step 2: Pick one LED within the assembly to be used as the DUT. The hottest LED in the assembly should be chosen, for example an LED in the middle of the assembly and next to a resistor.

Step 3: Solder a small thermocouple (approximately 0.25 mm in diameter) onto one of the cathode leads of the DUT near the top surface of the PCB. Large thermocouples, which can alter the thermal properties of the DUT, should be avoided.

Step 4: Assemble the modified PCB into the lamp housing such that the thermocouple wires are extending outside the lamp.

Step 5: Energize the entire lamp assembly at the design voltage for a minimum of 30 minutes. This will allow the lamp assembly to thermally stabilize.

Step 6: Measure the pin temperature of the DUT along with the ambient temperature in the room.

Step 7: Calculate the $R\theta_{pa}$ of the lamp assembly using the following equation:

$$R\theta_{pa} = \frac{T_p - T_a}{P}$$

Where the power, P , into the DUT is calculated by multiplying the heating/design current by its corresponding forward voltage.

Step 8: Calculate the $R\theta_{ja}$ of the lamp assembly by adding the $R\theta_{jp}$ of the emitter from Step 1 to $R\theta_{pa}$ from Step 7.

Junction-to-Ambient Thermal Resistance Measurement

These sections give detailed instructions on how to perform thermal resistance measurements on LED assemblies. The first method described in the box above, *Junction-to-Ambient Thermal Resistance Measurement Procedure*, allows for simple measurements to be made on lamp assemblies without an elaborate test setup. The second method presented, *Estimating Junction-to-Ambient Thermal Resistance*, eliminates the need for measured thermal resistance. This type of estimation is ideal for early evaluations, where an actual prototype and/or test equipment is

not available. An alternate method for measuring thermal resistance is provided in Appendix 4A.

This method monitors the change in forward voltage of the LED to determine the change in junction temperature and thermal resistance. This method requires an elaborate test setup and precise measurements. This technique is commonly used by Lumileds Lighting.

Lumileds will evaluate the thermal resistance of LED assemblies and signal lamps upon request. Please contact your local applications engineer for information.

Table 4.2

TYPICAL $R_{\theta_{JA}}$ VALUES FOR THE CLASSES OF LED LAMP ASSEMBLIES	
LED LAMP CLASSIFICATION	TYPICAL $R_{\theta_{JA}}$ ($^{\circ}C/W$)
CLASS 1	325
CLASS 2	400
CLASS 3	500
CLASS 4	650

Estimating Junction-to-Ambient Thermal Resistance

The procedures described in *Junction-to-Ambient Thermal Resistance Measurement Procedure* are accurate methods for determining the $R_{\theta_{JA}}$ of an LED within a plastic lamp assembly. However, in some cases, the time and/or equipment may not be available to perform such testing. In these cases, an educated estimate may be the best method available. Lumileds has developed some basic classifications of LED lamp assemblies and corresponding $R_{\theta_{JA}}$ estimates. Below is an explanation of the different classes, and the $R_{\theta_{JA}}$ estimates.

Class 1: Single row of LEDs with the current-limiting resistors/drive circuitry located off of the PCB, either in the wire harness assembly or on a separate PCB.

Class 2: Single row of LEDs with the current-limiting resistors/drive circuitry located on the same PCB as the LEDs. This is the most common situation for LED CHMSL assemblies.

Class 3: Multiple rows, or an x-y arrangement, of LEDs with the current-limiting resistors/ drive circuitry located off of the PCB, either in the wire harness assembly or on a separate PCB.

Class 4: Multiple rows, or an x-y arrangement, of LEDs with the current-limiting resistors/ drive circuitry located on the same PCB as the LEDs. This is the most common situation for LED rear combination lamp applications.

Table 4.2: lists the typical $R_{\theta_{JA}}$ values for each class of LED lamp assembly listed above. These are only estimates and should not be used for detailed, worst-case analyses.

Evaluation Junction Temperature and Forward Current

The primary concern when evaluating the thermal characteristics of an LED assembly is to ensure that the junction temperature of the LEDs is kept below the specified maximum value (125 $^{\circ}C$ for SuperFlux LEDs). There are three factors which determine junction temperature: 1) ambient temperature, 2) $R_{\theta_{JA}}$, and 3) power into the LED. Below is a sample junction temperature calculation, which illustrates how these three factors interact:

$$T_j = (R_{\theta_{JA}} \cdot P_{LED}) + T_a$$

$$= (R_{\theta_{JA}} \cdot I_{fLED} \cdot V_{fLED}) + T_a$$

Typical values for $T_{a(max)}$ are shown in Table 4.3.

To determine the worst-case, highest junction temperature, this equation becomes:

$$T_{jmax} = (R_{\theta_{JA}} \cdot P_{LEDmax}) + T_{amax}$$

$$= (R_{\theta_{JA}} \cdot I_{fmax} \cdot V_{fmax}) + T_{amax}$$

$$\leq 125^{\circ}C$$

Lumileds plots these curves for different values of $R_{\theta_{ja}}$ along with their intersection with the maximum drive current of 70 mA, and their intersection with the maximum ambient temperature of 100 °C and includes this graph in all LED data sheets. This graph is typically

referred to as the *derating curves*. The derating curves for HPWT-xx00 devices, are shown in Figure 4.4. Derating curves for HPWAxx00 devices are provided in the SuperFlux LED Technical Data Sheet. Refer to side-bar *Derating Example Cases* for further explanation.

Light Output and Forward Current

The relationship between light output and forward current for different thermal resistances is shown in Figure 4.5. For LED assemblies with low thermal resistances ($R_{\theta_{ja}} = 200 \text{ °C/W}$), the relative flux increases almost proportionally to the forward current. However, for LED assemblies with high thermal resistances ($R_{\theta_{ja}} = 600 \text{ °C/W}$), the relative flux can actually

decrease as forward current is increased. For assemblies with high $R_{\theta_{ja}}$, a great deal of heating occurs resulting in high junction temperatures. In these cases, the effects of increasing junction temperature can offset the effects of increasing forward current. Proper thermal management and drive current selection is critical to maximizing the performance of LEDs.

Derating Example Cases

Case 1—Class 1 LED CHMSL

Consider an LED CHMSL application using 12 HPWT-MH00 LEDs in a row, with a current limiting resistor in the wire connector. The auto manufacturer has specified a maximum ambient temperature of 75 °C.

From Table 4.2 the thermal resistance can be estimated as $R_{\theta_{ja}} = 325 \text{ °C/W}$. Using Figure 4.4, the maximum allowable forward current through each LED is 55 mA at $T_{a(max)} = 75 \text{ °C}$.

Case 2—Class 4 LED Rear Combination Lamp (RCL)

Consider an LED RCL application using 36 HPWTMH00 LEDs in a 6x6 pattern, with the drive circuitry on the same PCB as the LEDs. The auto manufacturer has specified a maximum ambient temperature of 75 °C.

From Table 4.2 the thermal resistance can be estimated as $R_{\theta_{ja}} = 650 \text{ °C/W}$. Using Figure 4.4, the maximum allowable forward current through each LED is 30 mA at $T_{a(max)} = 75 \text{ °C}$.

As can be seen from these simplified sample cases, the $R_{\theta_{ja}}$ has a major impact on junction temperature, and thus maximum allowable forward current. The different applications using the same LED have a difference in maximum forward current of nearly 2:1.

A more detailed determination of maximum forward current is presented in Application Brief 20-3 *Electrical Design Considerations for SuperFlux LEDs*.

Recommended Design Practices for Proper Thermal Management

PCB Design

Proper PCB design can reduce the $R_{\theta_{ja}}$ of a LED lamp assembly, and thus reduce the junction temperature of the LEDs. Listed below are some recommended practices for the design of LED PCBs.

Maximum Metallization

Conventional PCB design involves connecting various points on the board with traces of sufficient width to handle the current load. This process is usually visualized as adding traces to a blank PCB. For LED PCBs, this process should be reversed—visualized as removing metal only where needed to form the electrical circuit. Large metal pads surrounding the

cathode leads of the LEDs are ideal. Very little heat is conducted through the anode leads of the LED, so additional metallization surrounding these leads does not help.

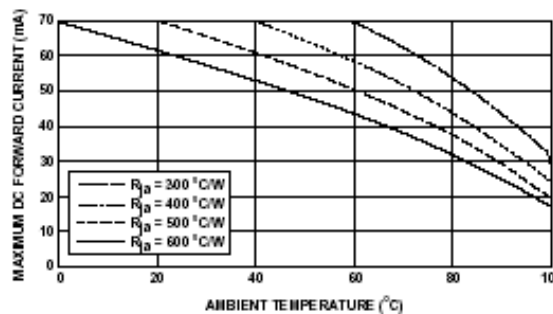

Figure 4.4 Graph of HPWT-xxOO Derating Curves.

Table 4.3

TYPICAL $T_{a(max)}$ VALUES FOR AUTOMOTIVE SIGNAL LAMPS

APPLICATION	TYPICAL $T_{a(max)}$ (°C)
EXTERIOR-MOUNTED SIGNAL LAMP	70
INTERIOR-MOUNTED CHMSL	80
INTERIOR, HEAD-LINER MOUNTED CHMSL	90

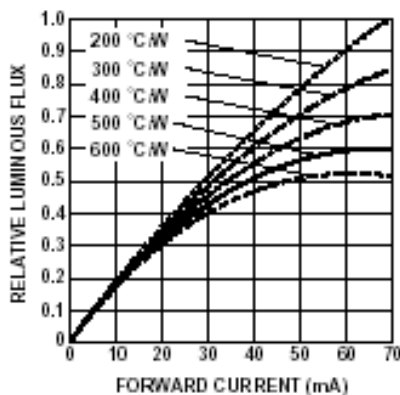

Figure 4.5 Relative Luminous Flux vs. Forward Current.

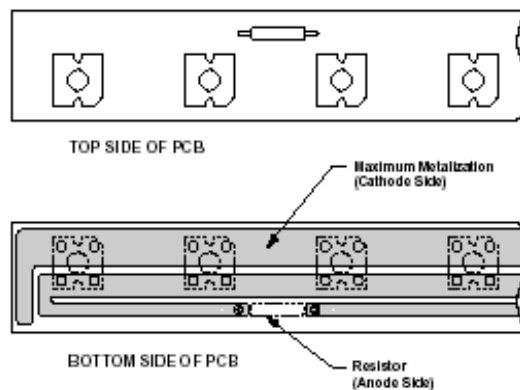

Figure 4.6 LED CHMSL PCB with proper metallization and component placement.

The resistors should be located in a remote portion of the PCB (away from the LEDs), on a separate PCB, or in the wire harness if possible. If this is not possible, the resistors should be distributed evenly along the PCB to distribute the heat generated. In addition, the traces from resistors to metallized areas surrounding cathode leads on the LEDs should be

minimized to prevent resistors from heating adjacent LEDs. This can be accomplished by thinning down these traces, or by having metallized areas contacting the LEDs and resistors only contact the anode leads of the LED. A portion of an LED CHMSL PCB depicting the design concepts discussed is shown in Figure 4.6.

LED Spacing

Most of the electrical power in an LED is dissipated as heat. Tighter LED spacing provides a smaller area for heat dissipation, resulting in higher PCB temperatures and thus higher junction temperatures. The LEDs should be spaced as far apart as packaging and

optical constraints will allow. Most CHMSL applications use only a single row of LEDs at spacing greater than 15 mm which is ideal, as opposed to many amber turn signal applications which use a tightly spaced (less than 10 mm) x-y array of LEDs.

Lamp Housing Design and Mounting of the LED Array

LED lamp housings should be designed to provide a conductive path from the backside of the PCB to the lamp housing. This is typically accomplished by mounting the backside of the PCB directly to the lamp housing such that they are contacting one another across the entire length of the PCB. This mounting scheme can be improved by applying a thermally conductive pad between the PCB and the lamp housing. The thermally conductive pad conforms to the features on the backside of the PCB and provides a larger contact area for conduction.

Often the PCB is mounted to the lamp housing on top of raised bosses. In this case, the area for conduction into the lamp housing is reduced to the contact area on the top side of the bosses, greatly reducing its effectiveness. Another common configuration mounts the

PCB along its top and bottom edges to slots in the side of the lamp housing. Again, the area for conduction into the lamp housing is reduced to the contact areas of the slots, which reduces the effectiveness of conduction.

If the PCB is mounted in such a way that conduction to the lamp housing is not effective (trapped air is a very poor conductor of heat), then allowances for convective cooling should be made. The most common technique to take advantage of natural convection is to put holes in the top and bottom side of the lamp housing to allow for vertical air flow over the PCB. However, where the lamp housing must be sealed for environmental reasons, this type of approach is impractical.

Circuit Design

Circuit design can help control the junction temperature of the LEDs in two important ways:

1) minimize fluctuations in the drive current (power input), and 2) dissipate a minimum amount of heat, or dissipate heat in such a way as to minimize its effect on the LEDs.

Current Control

An ideal drive circuit will provide the same current to the LEDs even as ambient temperatures and battery voltages vary.

Inexpensive, simple current control circuits can be designed to accomplish this task.

A schematic of such a circuit is shown in Figure 4.7.

Current control circuits are often too expensive and unnecessary for LED CHMSL applications. The most common LED CHMSL drive circuit consists of a current limiting resistor(s) and a silicon diode for reverse voltage protection in series with the LEDs. In this circuit design, the input current into the LEDs varies as the battery voltage changes. The current control characteristics of this type of circuit improve as larger resistor/s are used with fewer LEDs in series. However, circuits with fewer LEDs in series will have greater heat generation in the drive circuit. Figure 4.8 graphs the forward current provided to the LEDs vs. the input battery voltage for resistor circuits with three, four, and five LEDs in series.

For more information on picking the optimum design current, and LED drive circuit for your application, please reference Application Brief 20-3 *Electrical Design Considerations for SuperFlux LEDs*.

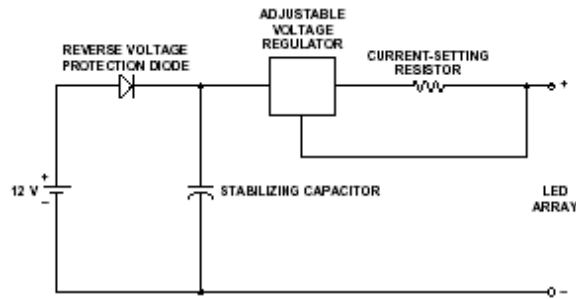

Figure 4.7 Schematic of a current control circuit for LED automotive lamp applications.

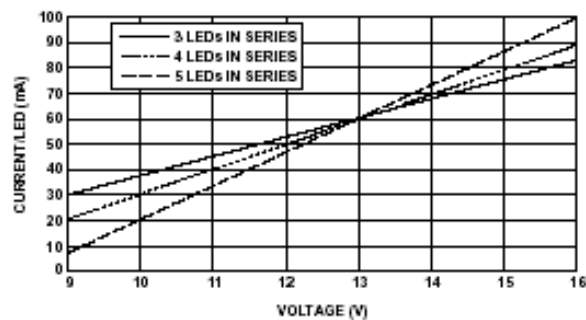

Figure 4.8 LED forward current vs. battery voltage for circuits of two, three, four and five LEDs in series with a current limiting resistor.

Power Dissipation

If the LED drive circuit is in a remote location relative to the LEDs (in the wire harness or on a separate PCB), then the power dissipated by the drive circuit does not affect the junction temperature of the LEDs. Drive circuit heating is a concern when the drive circuit is on the same PCB as the LEDs. Drive circuit power dissipation, and thus heat generation is inversely proportional to the number of LEDs in series. Circuits with fewer LEDs in series will have greater heat generation in the drive circuit.

For most automotive applications in which the battery voltage is approximately 13 V, Lumileds recommends configuring four LEDs in series. Four LEDs in series is a good compromise between forward current control, heat generation, and minimum turn-on voltage for the LED array.

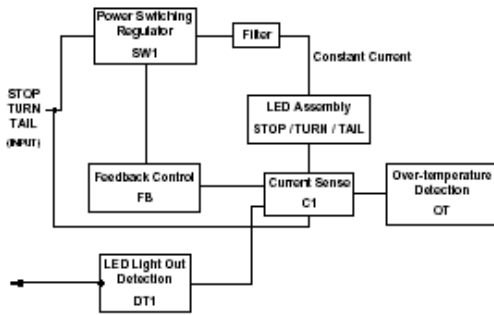

Figure 4.9 LED driver module for automotive lighting applications.

“Switching” Power Supplies

Current sources, which operate efficiently over a wide range on input voltages, can be designed using pulse-width modulation (PWM) circuitry. Such circuits have the advantage of low heat dissipation, and large input voltage compliance. This type of power supply is traditionally used in applications where electrical efficiency and heat dissipation are of critical importance, such as a laptop computer. Due to their widespread adoption in other applications, the cost of components has decreased, and their availability has increased, making this an interesting alternative for driving LED arrays.

A block diagram of a simple switching current source is shown in Figure 4.9.

The PWM module varies the pulse width based on the input and feedback voltages. The feedback voltage is proportional to the current through the LED array, where voltage is measured directly above a small fixed resistance connected to ground. The filter circuitry is used to smooth out the output voltage of the PWM / transistor switch. With minor modifications, this type of circuit can be used to drive multiple LED arrays and a variety of drive circuits.

Ambient Temperature Compensation

Drive circuitry can be designed which compensates for increasing ambient temperature by decreasing the forward current to the LED array. This allows the lamp designer to drive the LED array at a higher forward current by reducing the amount of current derating.

Temperature compensation is achieved by incorporating temperature sensitive components into the drive circuitry, such as positive temperature coefficient (PTC) resistors. An example of the resistance vs. temperature characteristics of a PTC resistor is shown in Figure 4.10.

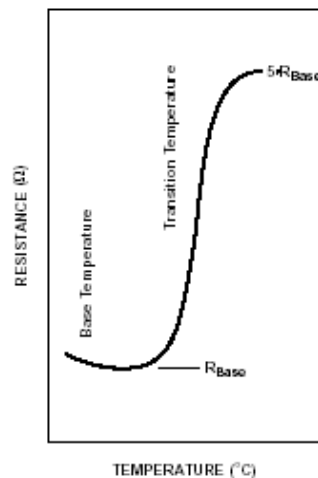

Figure 4.10 Resistance-Temperature curve for PTC resistor.

It can be seen that the resistance of such a device radically increases when the body temperature of the PTC resistor reaches the switching temperature. By designing a drive circuit such that the switching temperature occurs at a temperature less than $T_{a(max)}$, full current derating is not necessary.

Consider the case in which the switching temperature of the PTC resistor is achieved at an

ambient temperature of 50 °C at the maximum input voltage. The forward current at $T_a < 50$ °C is 55 mA, and due to the increase in resistance the forward current at $T_a > 50$ °C is 30 mA. In such a case, the maximum junction temperature will be achieved at 50 °C, therefore, 50 °C can be used as $T_{a(max)}$ in the current derating calculations.

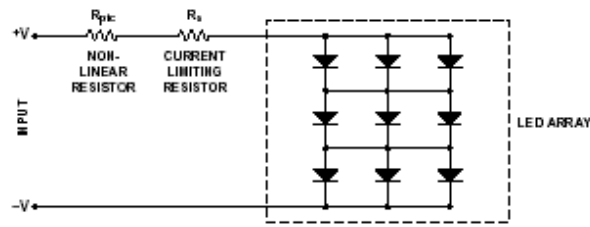

Figure 4.11 Current control circuit using temperature compensation.

An example of a current control circuit using temperature compensation is shown in Figure 4.11.

Appendix 4A

Alternate Junction-to-Ambient Thermal Resistance Measurement Procedure

Step 1: Pick one LED within the assembly to be used as the DUT. The hottest LED in the assembly should be chosen, for example an LED in the middle of the assembly and next to a resistor.

Step 2: Electrically isolate the DUT from the rest of the circuit by cutting the appropriate Copper traces on the printed circuit board (PCB).

Step 3: Solder long thin wires onto one cathode lead and one anode lead of the DUT. These wires should be long enough to extend outside the lamp housing once it is reassembled because they will be used to apply the heating current and to measure the ΔV_f of the DUT.

Step 4: Complete the original circuit of the PCB assembly by attaching a dummy LED onto the PCB to take the place of the isolated DUT. This can be accomplished by soldering long, thin

wires to one cathode lead and to one anode lead of an LED, which is of the same type as the DUT. Next solder the other end of these wires directly to the PCB in such a way as to have this dummy LED take the place of the DUT in the circuit.

Step 5: Assemble the modified PCB into the lamp housing such that the dummy LED and the DUT wires are extending outside the lamp.

Step 6: Measure the initial V_f of the DUT at a very low test current. This test current should be low enough such that it causes a minimum amount of heating (1 mA is recommended).

Step 7: Energize the entire lamp assembly at the design voltage, and DUT at the design current for the individual LEDs for a minimum of 30 minutes. This will allow the lamp assembly to thermally stabilize.

Step 8: Measure the V_f of the DUT at the heating current (V_f , heating).

Step 9: Turn off all power to the lamp, and immediately (≤ 10 ms) re-measure the V_f of the DUT at the test current selected in 6).

Step 10: Calculate the ΔT_j of the DUT by dividing the ΔV_f ($\Delta V_f = V_f$ (Step 6) - V_f (Step 9)) by the appropriate factor in Table 4.3.

Step 11: Calculate the power, P , into the DUT by multiplying the heating/design current by its corresponding V_f , heating as determined in Step 8.

Step 12: Calculate $R_{\theta_{ja}}$ using the values of ΔT_j and P calculated in Steps 10 and 11. Lumileds can provide the $R_{\theta_{ja}}$ measurements of LED lamp assemblies as described above as a service to its LED customers.

Table 4.3

RATIOS OF THE CHANGE IN FORWARD VOLTAGE VS. THE CHANGE IN JUNCTION TEMPERATURE FOR HIGH-BRIGHTNESS LED MATERIALS	
LED MATERIAL TYPE	$\Delta V_f / \Delta T_j$ (mV / °C)
AS ALINGAP	-2.0
TS ALINGAP	-2.0

Company Information

Lumileds is a world-class supplier of Light Emitting Diodes (LEDs) producing billions of LEDs annually. Lumileds is a fully integrated supplier, producing core LED material in all three base colors (Red, Green, Blue) and White. Lumileds has R&D development centers in San Jose, California and Best, The Netherlands. Production capabilities in San Jose, California and Malaysia.

Lumileds is pioneering the high-flux LED technology and bridging the gap between solid state LED technology and the lighting world. Lumileds is absolutely dedicated to bringing the best and brightest LED technology to enable new applications and markets in the Lighting world.

LUMILEDS™
LIGHT FROM SILICON VALLEY

©2002 Lumileds Lighting. All rights reserved. Lumileds Lighting is a joint venture between Agilent Technologies and Philips Lighting. Luxeon is a trademark of Lumileds Lighting, LLC. Product specifications are subject to change without notice.

Publication No. AB20-4 (Sept2002)

LUMILEDS

www.luxeon.com
www.lumileds.com

For technical assistance or the location of your nearest Lumileds sales office, call:

Worldwide:
+1 408-435-6044
US Toll free: 877-298-9455
Europe: +31 499 339 439
Asia: +65 6248 4759
Fax: 408-435-6855
Email us at info@lumileds.com

Lumileds Lighting, LLC
370 West Trimble Road
San Jose, CA 95131