

SMTC2-2500F



Phase Control Thyristor



Type	V_{RSM}	V_{RRM}, V_{DRM}
SMTC2-2500F-16	1700	1600
SMTC2-2500F-18	1900	1800
SMTC2-2500F-20	2100	2000
SMTC2-2500F-22	2300	2200
SMTC2-2500F-24	2500	2400
SMTC2-2500F-25	2600	2500

Type	I_{TAVM} $T_c=55^\circ\text{C}$	I_{TRMS}	I_{TSM}	$(di/dt)_{cr}$	$(dv/dt)_{cr}$	V_{TM}	I_{TM}	V_{TO}	r_T	V_{GT}	I_{GT}	T_{VJM}	R_{thJC}	F
	A	kA	kA	A/ μs	V/ μs	V	kA	V	m Ω	V	mA	$^\circ\text{C}$	K/W	kN
SMTC2-2500F	2500	5.2	31	600	500-1000	2.85	5.0	1.30	0.14	4.5	300	115	0.011	47

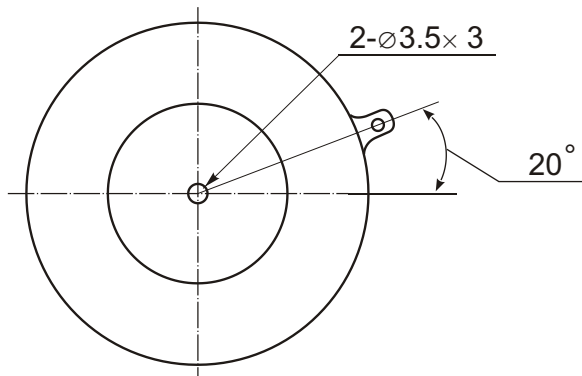

Type	t_q ($T_c=105^\circ\text{C}$)
	μs
SMTC2-2500F-xx-KED12	40
SMTC2-2500F-xx-JED12	50
SMTC2-2500F-xx-IED12	60
SMTC2-2500F-xx-HED12	80

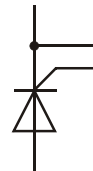
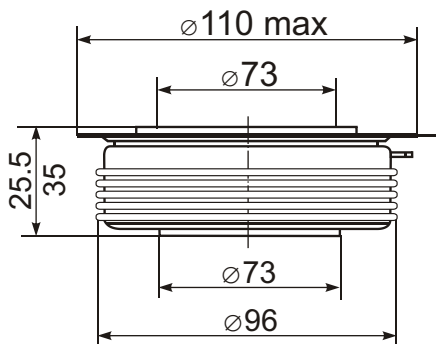

Features:

- Hermetic metal case with ceramic insulator
- Capsule packages for double sided cooling
- International standard case
- Amplifying gates

Typical Applications:

- DC motor control
- AC motor soft starter
- Controlled rectifiers
- AC controllers