

SMDD-500



Diode-Diode Module



Type	V_{RSM}	V_{RRM}
SMDD-500-08	900	800
SMDD-500-12	1300	1200
SMDD-500-14	1500	1400
SMDD-500-16	1700	1600
SMDD-500-18	1900	1800

Type	I_{FAVM}	I_{FRMS}	T_c	I_{FSM}	i^2t	V_{TM}	I_{FM}	V_{FO}	r_F	T_{VJM}	V_{isol}	R_{thJC}
	A	A	$^{\circ}C$	KA	KA ² s	V	A	V	m Ω	$^{\circ}C$	V	K/W
SMDD-500	500	750	100	9.5	450	1.5	720	0.8	0.56	150	2500	0.078

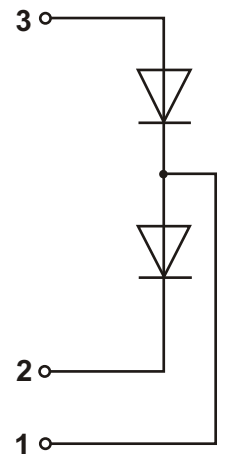
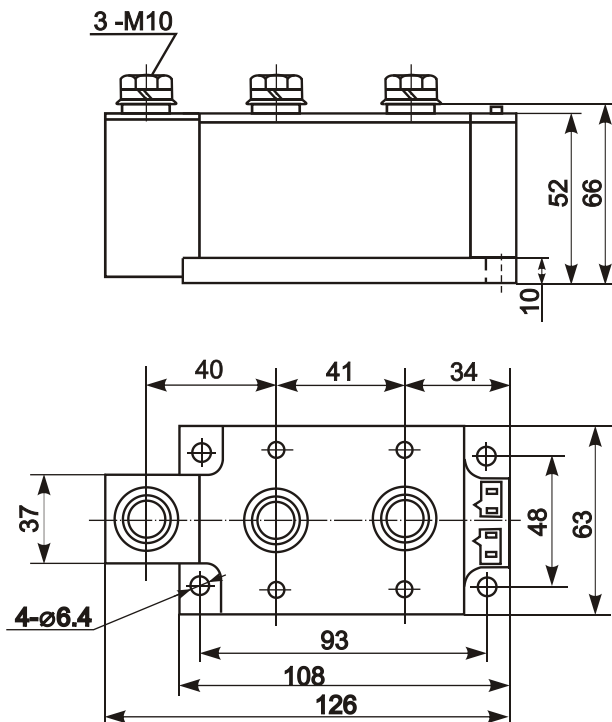

Features:

- Industrial standard package
- Heat transfer through aluminium nitride ceramic isolated metal baseplate
- Precise internal pressure contacts for high reliability
- 2500V RMS isolation voltage

Typical Applications:

- DC power supply for instrument and equipment
- Power converters
- Electronic welders
- Lighting control