

SGM9110

8MHz Rail-to-Rail Composite Video Driver with 6dB Gain

PRODUCT DESCRIPTION

The SGM9110 is single rail-to-rail 3-pole output reconstruction filter with a -3dB bandwidth of 8MHz and a slew rate of 40V/ μ s. Operating from single supplies ranging from +2.5V to +5.5V and sinking an ultra-low 2.65mA quiescent current, the SGM9110 is ideally suited for low power, battery-operated applications.

The output swings within 100mV of GND and 170mV to V+ with a standard back-terminated video load (150 Ω). SGM9110 employs an internal level shift circuit that avoids sync-pulse clipping and allows DC-coupled output. If AC-coupling is preferred, the SGM9110 offers a sag-correction feature that significantly reduces the size of the output coupling capacitor.

SGM9110 has a power-down disable feature that reduces the supply current to 2 μ A, dramatically reducing power consumption and prolonging battery life.

It is specified over the extended -40 $^{\circ}$ C to +125 $^{\circ}$ C temperature range.

BLOCK DIAGRAM

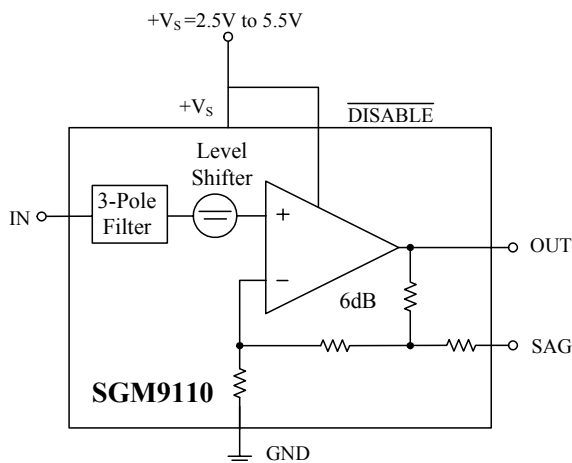

FEATURES

- Low Cost
- Excellent Video Performance
- 3-Pole Reconstruction Filter
- Internal Gain: 6dB
- Rail-to-Rail Output
- SAG Correction
 - Reduces AC Coupling Capacitor size
- Input Voltage Range Includes Ground AC-Coupled Input
- Operates on 2.5 V to 5.5 V Single-Supplies
- Low Power
 - 2.65 mA Typical Supply Current
 - SGM9110 2 μ A when Disabled
- Small Packaging
 - SGM9110 Available in SC70-6

APPLICATIONS

Video amplifiers
Cable and Satellite set top boxes
Communications devices
Video on demand
Portable and handheld products
Personal video recorders
DVD players
HDTV

PIN CONFIGURATIONS (Top View)

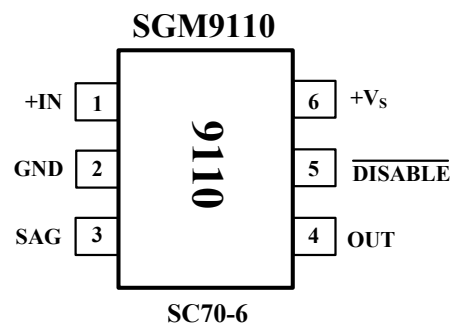

ELECTRICAL CHARACTERISTICS: $V_S = +3.3V$

(At $R_L = 150\Omega$ connected to GND, and $C_{IN} = 0.1\mu F$, unless otherwise noted)

PARAMETER	CONDITION	SGM9110							
		TYP	MIN/MAX OVER TEMPERATURE					UNITS	MIN/MAX
		+25°C	+25°C	0°C to 70°C	-40°C to 85°C	-40°C to 125°C			
INPUT CHARACTERISTICS									
Output Level Shift Voltage (V_{OLS})	$V_{IN} = 0V$, no load	106	130	135	145	175	mV	MAX	
Input Bias Current (I_B)							pA	TYP	
Input Voltage Clamp (V_{CLAMP})	$I_{IN} = -1mA$	-61	-65	-70	-73	-80	mV	MIN	
Clamp Charge Current	$V_{IN} = V_{CLAMP} - 100mV$	-2.7	-2.8	-2.82	-2.84	-2.86	mA	MIN	
Clamp Discharge Current	$V_{IN} = 500mV$	4	5	6	6.5	7	μA	MAX	
Input Resistance (R_{IN})	$0.5V < V_{IN} < 1.0V$						M Ω	MIN	
Voltage Gain (A_V)	$R_L = 150\Omega$	2.0	1.97	1.968	1.966	1.93	V/V	MIN	
			2.03	2.032	2.034	2.07	V/V	MAX	
SAG Correction DC Gain to V_{OUT} (A_{SAG})	SAG open						V/V	TYP	
Input Offset Voltage Drift ($\Delta V_{OS}/\Delta T$)							$\mu V/^\circ C$	TYP	
OUTPUT CHARACTERISTICS									
Output Voltage High Swing	$V_{IN} = 2V$, $R_L = 150\Omega$ to GND	3.13	3.1	3.05	3.03	3.0	V	MIN	
Output Short-Circuit Current (I_{SC})	$V_{IN} = 2V$, to GND through 10Ω	105	100	100	95	90	mA	MIN	
	$V_{IN} = 100mV$, out short to V_{DD} through 10Ω	-120	-110	-108	-107	-105	mA	MAX	
POWER SUPPLY									
Operating Voltage Range			2.5	2.7	2.7	2.7	V	MIN	
			5.5	5.5	5.5	5.5	V	MAX	
Power Supply Rejection Ratio (PSRR)	$V_S = +2.7V$ to $+5.5V$	70	62	61	60	58	dB	MIN	
Quiescent Current (I_Q)	$V_{IN} = 500mV$, $\overline{Disabled} = V_S$, no load	2.65	2.94	3.03	3.12	3.39	mA	MAX	
Supply Current when Disabled	$\overline{Disabled} = 0V$	2	4	4.5	5	6	μA	MAX	
DYNAMIC PERFORMANCE									
$\pm 0.1dB$ Bandwidth	$R_L = 150\Omega$, $C_L = 5pF$	4.4					MHz	TYP	
-3dB Bandwidth	$R_L = 150\Omega$, $C_L = 5pF$	8.0					MHz	TYP	
Filter Response									
Normalized Gain: $f_{IN} = 4.5MHz$		+0.15					dB	TYP	
$f_{IN} = 27MHz$		-22					dB	TYP	
Slew Rate	10% to 90%, $V_{IN} = 1V$ Step,	40					V/ μs	TYP	
Differential Gain Error (DG)	NTSC & PAL DC coupled	0.46					%	TYP	
	NTSC & PAL AC coupled	1.2					%	TYP	
Differential Phase Error (DP)	NTSC & PAL DC coupled	0.8					$^\circ$	TYP	
	NTSC & PAL AC coupled	1.0					$^\circ$	TYP	
Group Delay Variation (D/DT)	$f = 100KHz, 5MHz$	8					ns	TYP	
Fall Time	$2.5V_{STEP}$, 80% to 20%	30					ns	TYP	
Rise Time	$2.5V_{STEP}$, 80% to 20%	40					ns	TYP	
POWER-DOWN DISABLE									
Disabled (logic-LOW Threshold)	$V_S = +2.7V$ to $+3.3V$		0.8				V	MAX	
$\overline{Disabled}$ (logic-HIGH Threshold)	$V_S = +2.7V$ to $+3.3V$		1.6				V	MIN	
Disable Time	$V_{IN} = 500mV$, V_{OUT} to 1%	360					ns	TYP	
$\overline{Disable}$ Time	$V_{IN} = 500mV$, V_{OUT} to 1%	90					ns	TYP	
$\overline{Disable}$ Current	$\overline{Disable}$ pin = 0V	20					nA	MAX	

Specifications subject to change without notice.

PACKAGE/ORDERING INFORMATION

ORDER NUMBER	PACKAGE DESCRIPTION	TEMPERATURE RANGE	PACKAGE OPTION	MARKING INFORMATION
SGM9110XC6/TR	SC70-6	-40°C to +125°C	Tape and Reel, 3000	9110

ABSOLUTE MAXIMUM RATINGS

Supply Voltage, V+ to V-	7.5 V
Input Voltage	GND – 0.3 V to (+Vs) +0.3V
Storage Temperature Range	–65°C to +150°C
Junction Temperature	160°C
Operating Temperature Range	–40°C to +125°C
Power Dissipation, P _D @ T _A = 25°C	
SC70-6	0.3W
Package Thermal Resistance	
SC70-6, θ _{JA}	330°C/W
Lead Temperature Range (Soldering 10 sec)	
.....	260°C
ESD Susceptibility	
HBM.....	1000V
MM.....	400V

NOTES

1. Stresses above those listed under Absolute Maximum Ratings may cause permanent damage to the device. This is a stress rating only; functional operation of the device at these or any other conditions above those indicated in the operational section of this specification is not implied. Exposure to absolute maximum rating conditions for extended periods may affect device reliability.

CAUTION

This integrated circuit can be damaged by ESD. Shengbang Micro-electronics recommends that all integrated circuits be handled with appropriate precautions. Failure to observe proper handling and installation procedures can cause damage. ESD damage can range from subtle performance degradation to complete device failure. Precision integrated circuits may be more susceptible to damage because very small parametric changes could cause the device not to meet its published specifications.

TYPICAL PERFORMANCE CHARACTERISTICS

At $V_S = +3.3V$, $T_A = +25^\circ C$, $R_L = 150\Omega$, $C_L = 5pF$ unless otherwise noted.

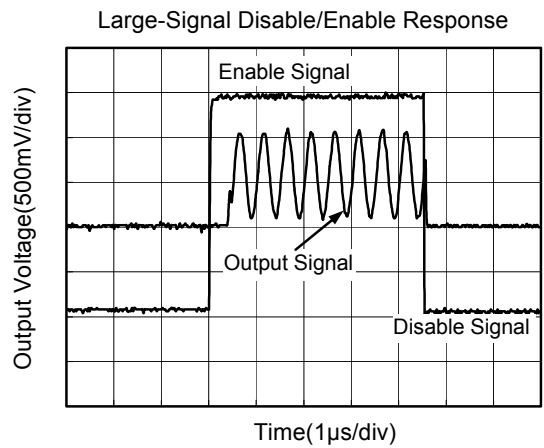
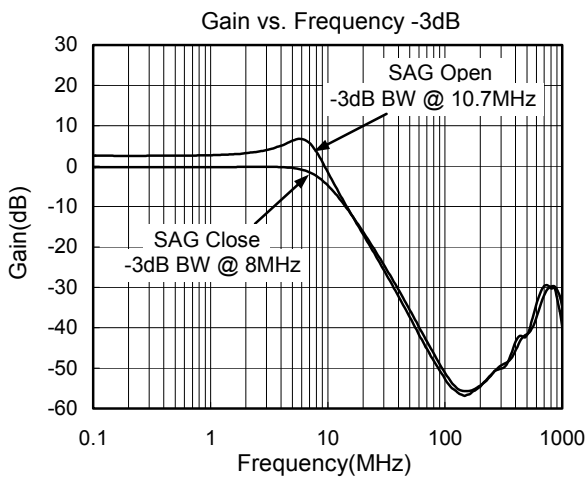
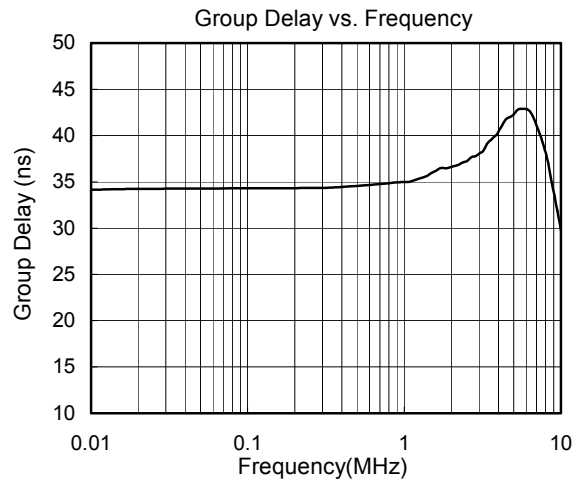
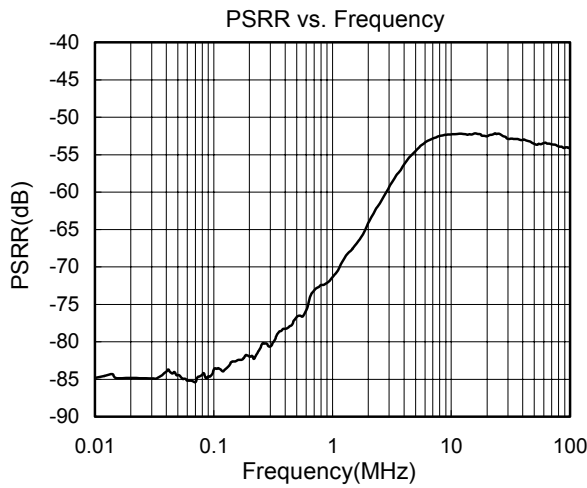
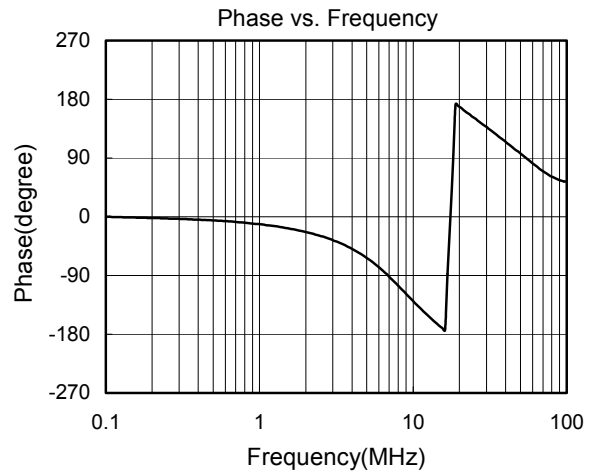
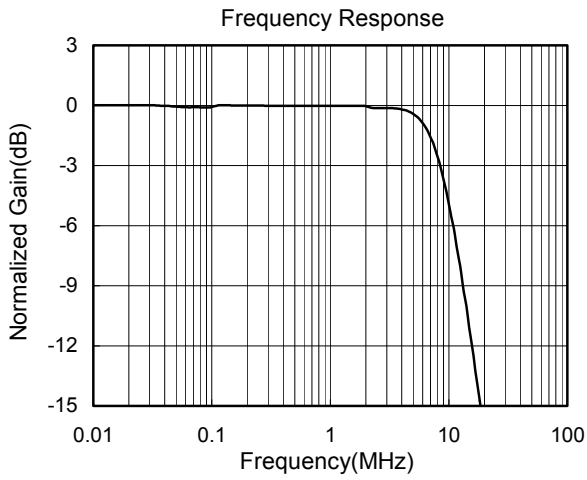

TYPICAL PERFORMANCE CHARACTERISTICS

At $V_S = +3.3V$, $T_A = +25^\circ C$, $R_L = 150\Omega$, $C_L = 5pF$ unless otherwise noted.

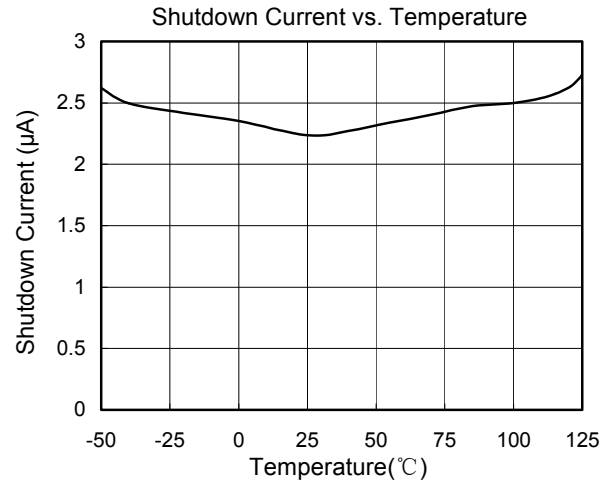
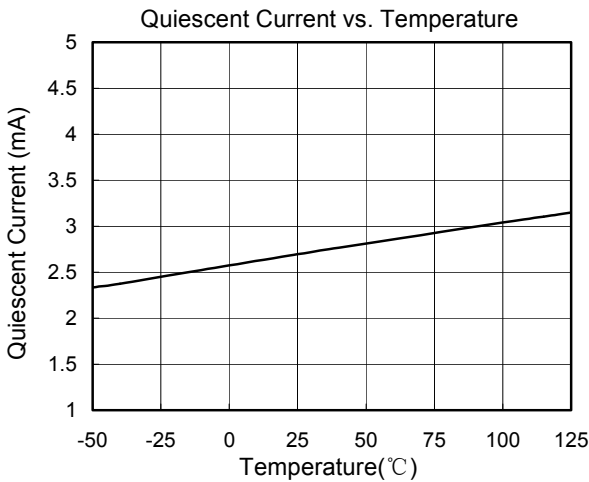
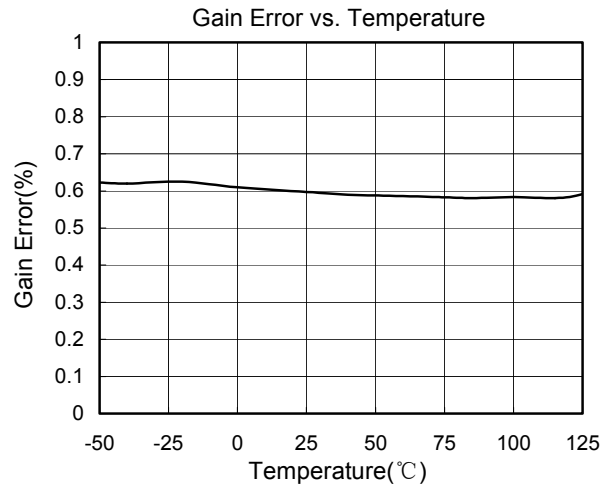
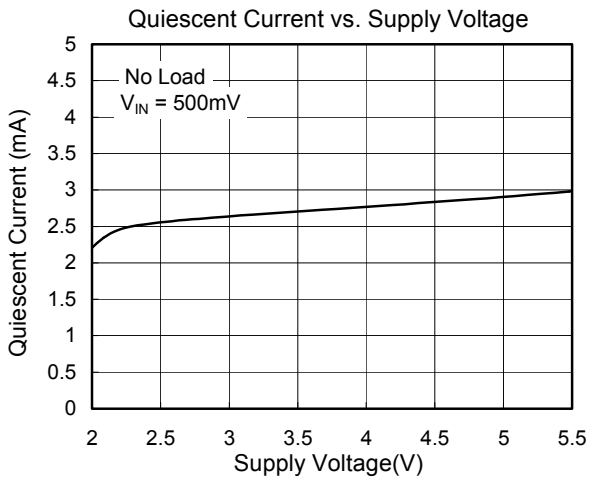
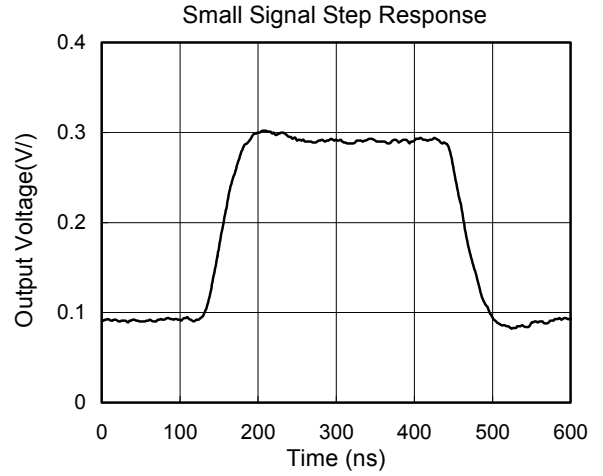
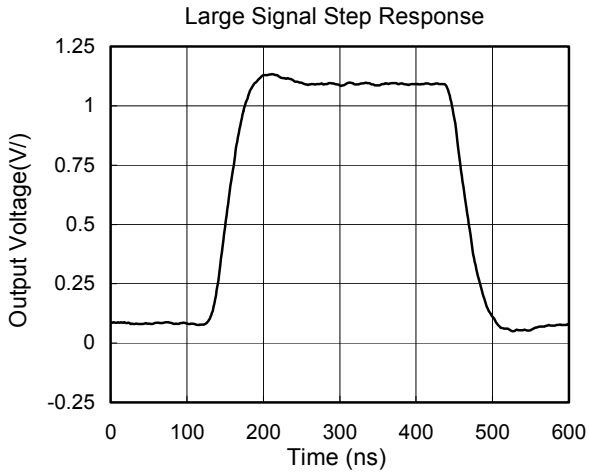

TYPICAL PERFORMANCE CHARACTERISTICS

At $V_S = +3.3V$, $T_A = +25^\circ C$, $R_L = 150\Omega$, $C_L = 5pF$ unless otherwise noted.

Output Voltage Swing to The Positive Rail vs. Output Current

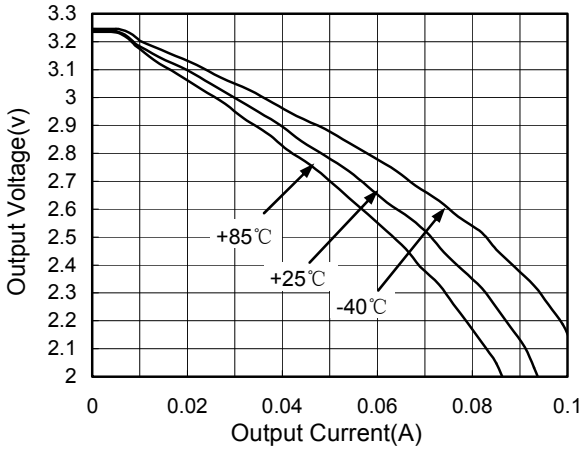

Output Voltage Swing to The Negative Rail vs. Output Current

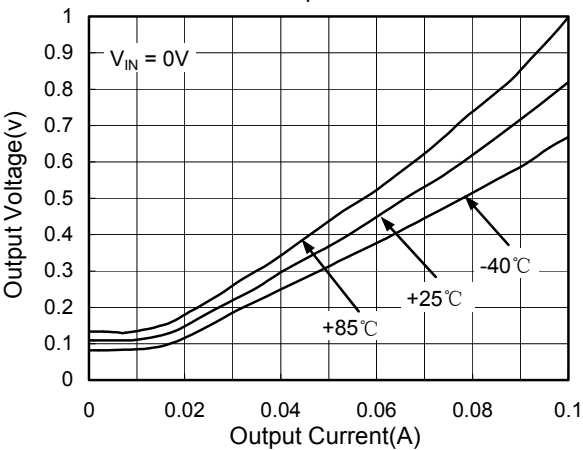

Application Information

The SGM9110 low cost, integrated, 3-pole, video filter is intended to replace passive LC filters and drivers in low voltage portable video applications. The 3-pole filter provides better image quality compared to typical 2-pole solutions.

The SGM9110 input must be AC-coupled because the input capacitor stores the clamp voltage. It needs a typical value of $0.1\mu\text{F}$ for the input clamp to meet the Line Droop specification. The SGM9110 output can drive an AC or DC-coupled doubly terminated coax (150Ω) load (see Figure 1). DC-coupling the output removes the need for an expensive and large output coupling capacitor (see Figure 2). If an AC-coupled output is needed, the SAG correction circuit can be used to reduce the AC output coupling capacitor value.

Offering SAG correction, fixed gain of 6dB, and a 3-pole low pass filter in a tiny space saving package makes the SGM9110 well suited for space sensitive applications such as digital cameras, cellular phones and other portable devices.

Enable/Shutdown

The SGM9110 has a shutdown feature that disables the output and reduces the quiescent current to $2\mu\text{A}$. This feature is particularly useful in portable applications, such as video cameras, hand held gaming devices, cellular phones and requiring video filtering and drive capability.

Internal Sync Clamp

The typical embedded video DAC operates from a ground referenced single supply. This becomes an issue because the lower level of the sync pulse output may be at a 0V reference level to some positive level. The problem is presenting a 0V input to most single supply driven amplifiers will saturate the output stage of the amplifier resulting in a clipped sync tip and degrading the video image. A larger positive reference may offset the input above its positive range.

The SGM9110 features an internal sync clamp and offset function to level shift the entire video signal to the best level before it reaches the input of the amplifier stage. These features are also helpful to avoid saturation of the output stage of the amplifier by setting the signal closer to the best voltage range.

The typical Application diagram of the SGM9110 in Figure 1 is divided into four sections. The first, Section A is the Sync Clamp. The AC coupled video sync signal is pulled negative by a current source at the input of the comparator amplifier. When the sync tip goes below the comparator threshold the output comparator is driven negative, The PMOS device turns on clamping sync tip to near ground level. The network triggers on the sync tip of video signal.

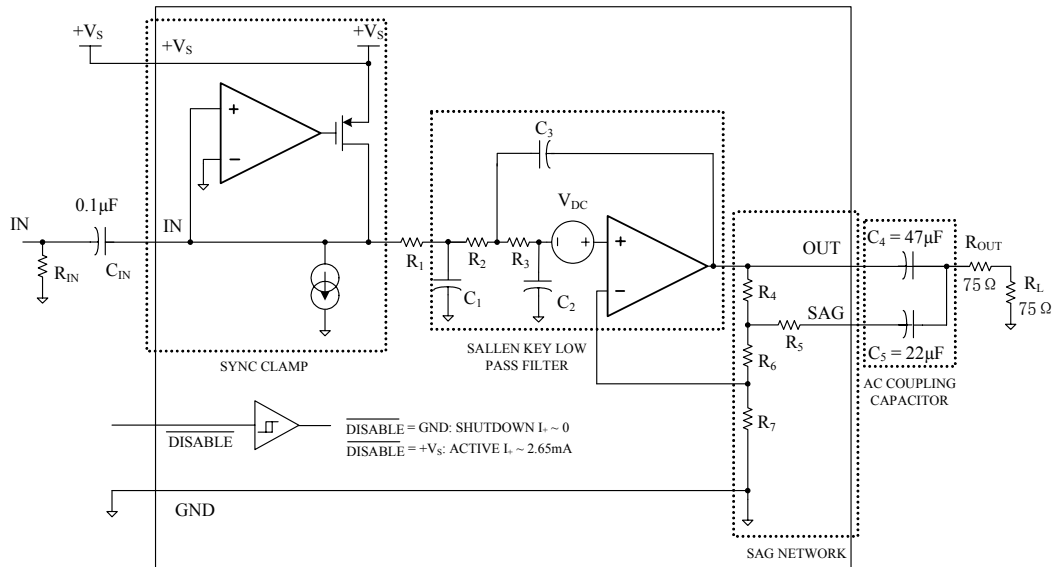

Figure 1. Typical Application Diagram

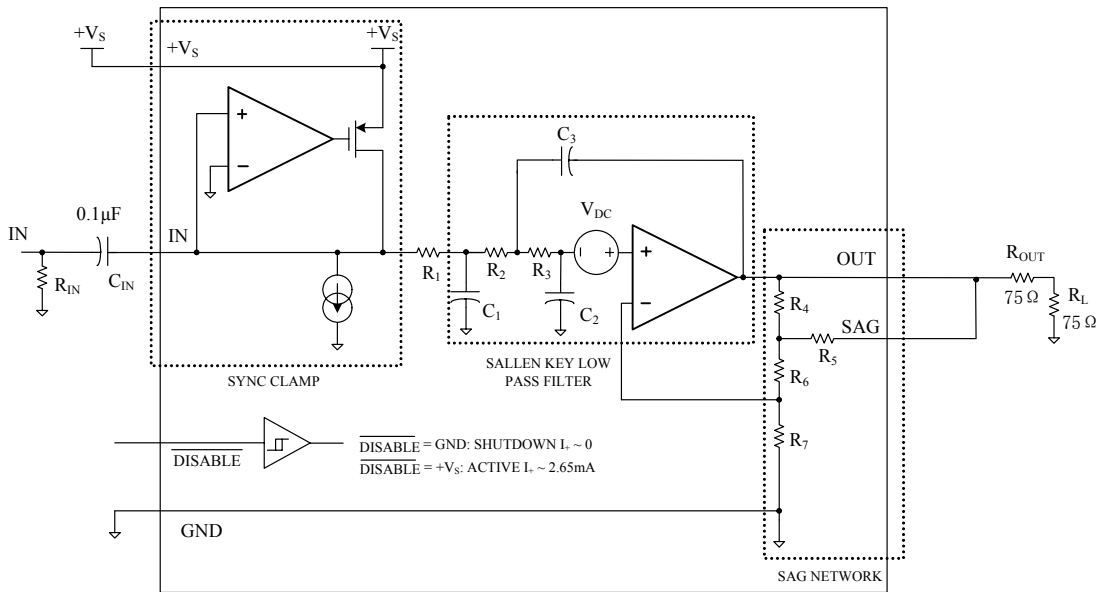

Figure 2. AC-Coupled Input/DC-Coupled Output

SAG Correction

The SGM9110 can use the SAG configuration if an AC-coupled output video signal is needed. SAG correction refers to the low-frequency compensation for the high pass filter formed by the 150Ω load and the output capacitor. In video applications, the cutoff frequency must be low enough to pass the vertical sync interval to avoid field tilt. This cutoff frequency should be less than 5Hz, and the coupling capacitor must be very large in normal configuration, typically is 220µF. In SAG configuration, the SGM9110 removes the need for large coupling capacitors, and instead needs one 22µF and one 47µF capacitors (Figure 1) to reach the same performance as the large capacitor.

The Sallen Key Low Pass Filter

The Sallen Key in a classic low pass configuration illustrated in Figure 1. The filter provides a very stable low pass function, and in the case of the SGM9110, a 3-pole roll-off at around 8MHz. The 3-pole function is accomplished with an RC low pass network placed in series with and before the Sallen Key. One pole provided by the RC network and poles two and three provided by the Sallen Key for a nice 3-pole roll-off at around 8MHz.

Layout and Power-Supply Bypassing

The SGM9110 operates from single 2.5V to 5.5V supply. Bypass the supply with a 0.1µF capacitor as close to the pin as possible. SGMC recommends using microstrip and stripline techniques to obtain full bandwidth. To ensure that the PC board does not degrade the device's performance, design it for a frequency greater than 1GHz. Pay careful attention to inputs and outputs to avoid large parasitic capacitance. Whether or not you use a constant-impedance board, observe the following design guidelines:

- Do not use IC sockets; they increase parasitic capacitance and inductance.
- Do not use wire-wrap boards; they are too inductive.
- Use surface-mount instead of through-hole components for better, high-frequency performance.
- Use a PC board with at least two layers; it should be as free from voids as possible.
- Keep signal lines as short and as straight as possible. Do not make 90° turns; round all corners.

PACKAGE OUTLINE DIMENSIONS

SC70-6

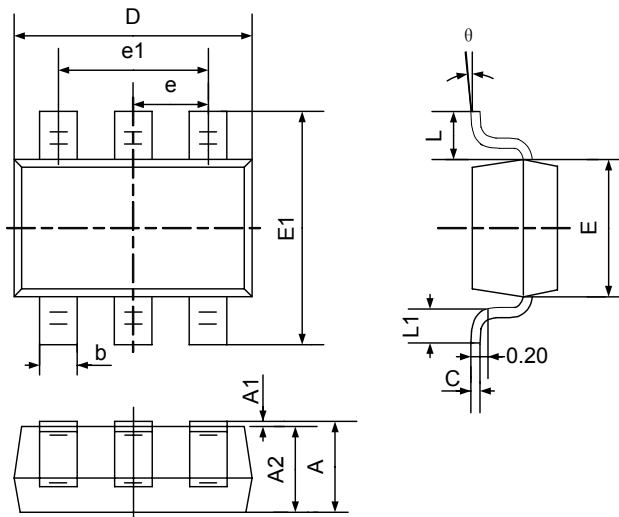

Symbol	Dimensions In Millimeters		Dimensions In Inches	
	Min	Max	Min	Max
A	0.900	1.100	0.035	0.043
A1	0.000	0.100	0.000	0.004
A2	0.900	1.000	0.035	0.039
b	0.150	0.350	0.006	0.014
c	0.080	0.150	0.003	0.006
D	2.000	2.200	0.079	0.087
E	1.150	1.350	0.045	0.053
E1	2.150	2.450	0.085	0.096
e	0.650TYP		0.026TYP	
e1	1.200	1.400	0.047	0.055
L	0.525REF		0.021REF	
L1	0.260	0.460	0.010	0.018
θ	0°	8°	0°	8°

REVISION HISTORY

Location	Page
<hr/>	
11/06— Data Sheet changed from preliminary to REV. A	
Changes to ABSOLUTE MAXIMUM RATINGS	3

Shengbang Microelectronics Co, Ltd

Unit 3, ChuangYe Plaza
No.5, TaiHu Northern Street, YingBin Road Centralized Industrial Park
Harbin Development Zone
Harbin, HeiLongJiang 150078
P.R. China
Tel.: 86-451-84348461
Fax: 86-451-84308461
www.sg-micro.com