



Typical Applications

Low noise MMIC VCO w/Buffer Amplifier for:

- Wireless Local Loop (WLL)
- VSAT & Microwave Radio
- Test Equipment & Industrial Controls
- Military

Features

- Pout: +4.7 dBm
- Phase Noise: -112 dBc/Hz @100 KHz
- No External Resonator Needed
- Single Supply: 3V @ 42 mA
- QFN Leadless SMT Package, 16 mm²

Functional Diagram

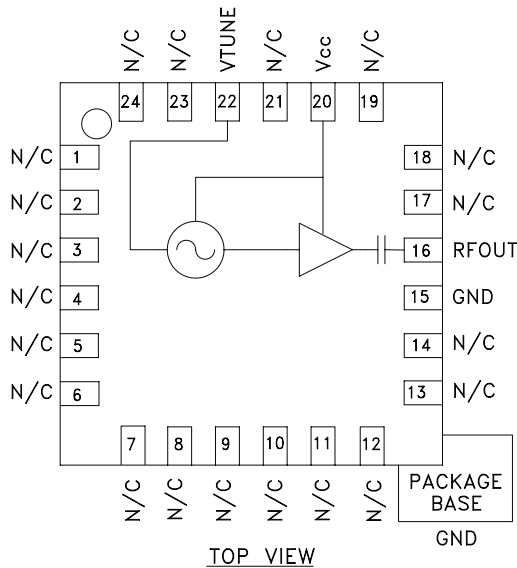

General Description

The HMC390LP4 & HMC390LP4E are GaAs InGaP Heterojunction Bipolar Transistor (HBT) MMIC VCOs with integrated resonators, negative resistance devices, varactor diodes, and buffer amplifiers. Covering 3.55 to 3.9 GHz, the VCO's phase noise performance is excellent over temperature, shock, vibration and process due to the oscillator's monolithic structure. Power output is 4.7 dBm typical from a single supply of 3V @ 42 mA. The voltage controlled oscillator is packaged in a low cost leadless QFN 4 x 4 mm surface mount package.

Electrical Specifications, $T_A = +25^\circ C$, $V_{cc} = +3V$

| Parameter | Min. | Typ. | Max. | Units |
|--|------------|------|------|-----------------|
| Frequency Range | 3.55 - 3.9 | | | GHz |
| Power Output | 1.5 | 4.7 | | dBm |
| SSB Phase Noise @ 100 kHz Offset, $V_{tune} = +5V$ @ RF Output | | -112 | | dBc/Hz |
| Tune Voltage (V_{tune}) | 0 | | 10 | V |
| Supply Current (I_{cc}) ($V_{cc} = +3.0V$) | | 42 | | mA |
| Tune Port Leakage Current | | | 10 | μA |
| Output Return Loss | | 6 | | dB |
| Harmonics | | | | |
| 2nd | | 5 | | dBc |
| 3rd | | 16 | | dBc |
| Pulling (into a 2.0:1 VSWR) | | 3.3 | | MHz pp |
| Pushing @ $V_{tune} = +5V$ | | -5 | | MHz/V |
| Frequency Drift Rate | | 0.4 | | MHz/ $^\circ C$ |

MMIC VCO w/ BUFFER AMPLIFIER, 3.55 - 3.9 GHz

Frequency vs. Tuning Voltage, $T = 25^{\circ}\text{C}$

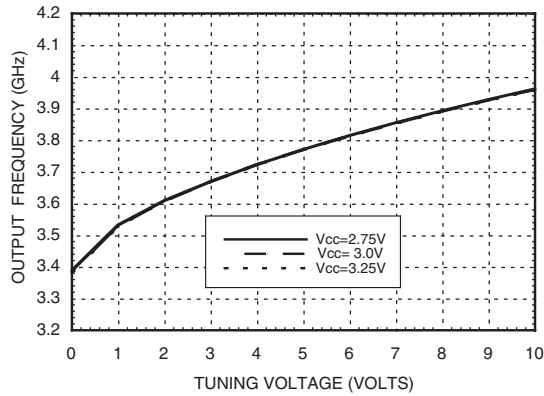

Frequency vs. Tuning Voltage, $V_{cc} = +3V$

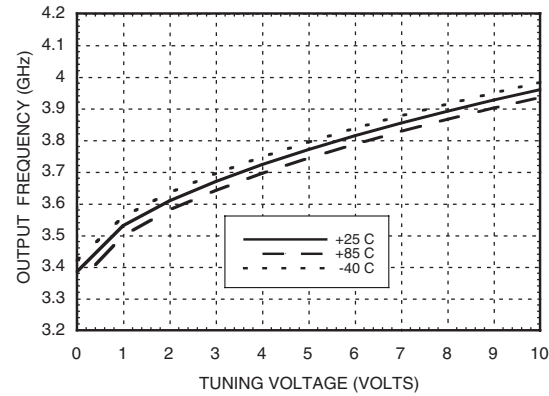

Sensitivity vs. Tuning Voltage, $V_{cc} = +3V$

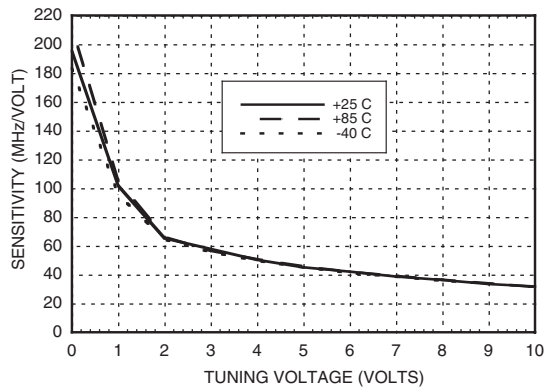

Output Power vs. Tuning Voltage, $V_{cc} = +3V$

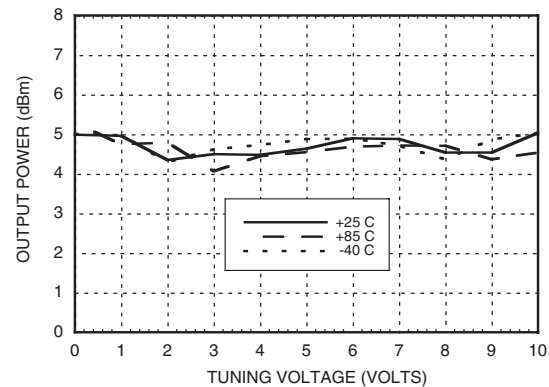

Phase Noise vs. Tuning Voltage

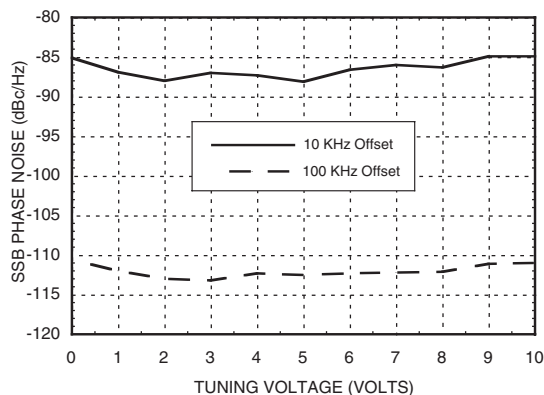

Typical SSB Phase Noise @ $V_{tune} = +5V$

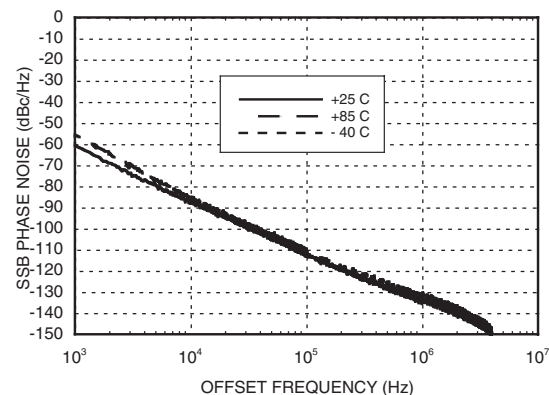

Absolute Maximum Ratings

| | |
|---|----------------|
| Vcc | +3.5 Vdc |
| Vtune | 0 to +11V |
| Channel Temperature | 135 °C |
| Continuous Pdiss (T = 85°C) (derate 6.28 mW/°C above 85°C) | 565 W |
| Storage Temperature | -65 to +150 °C |
| Operating Temperature | -40 to +85 °C |

Typical Supply Current vs. Vcc

| Vcc (V) | Icc (mA) |
|---------|----------|
| 2.75 | 35 |
| 3.0 | 42 |
| 3.25 | 47 |

Note: VCO will operate over full voltage range shown above.



ELECTROSTATIC SENSITIVE DEVICE
OBSERVE HANDLING PRECAUTIONS

Outline Drawing

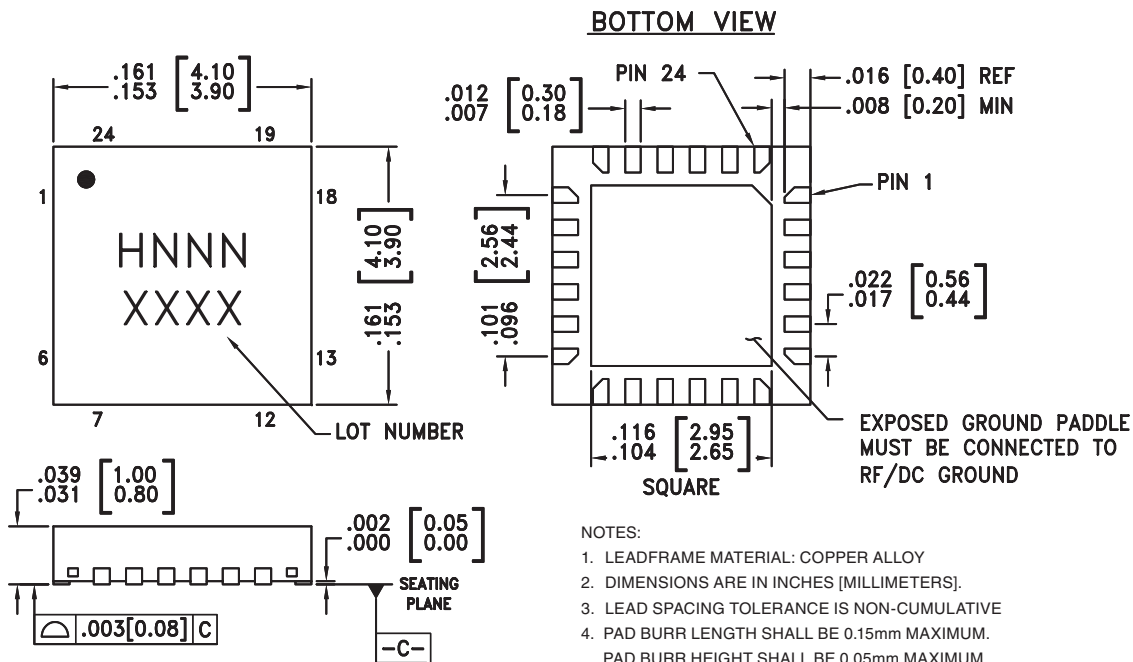

NOTES:

1. LEADFRAME MATERIAL: COPPER ALLOY
2. DIMENSIONS ARE IN INCHES [MILLIMETERS].
3. LEAD SPACING TOLERANCE IS NON-CUMULATIVE
4. PAD BURR LENGTH SHALL BE 0.15mm MAXIMUM. PAD BURR HEIGHT SHALL BE 0.05mm MAXIMUM.
5. PACKAGE WARP SHALL NOT EXCEED 0.05mm.
6. ALL GROUND LEADS AND GROUND PADDLE MUST BE SOLDERED TO PCB RF GROUND.
7. REFER TO HITTITE APPLICATION NOTE FOR SUGGESTED PCB LAND PATTERN

Package Information

| Part Number | Package Body Material | Lead Finish | MSL Rating | Package Marking ^[3] |
|-------------|--|---------------|---------------------|--------------------------------|
| HMC390LP4 | Low Stress Injection Molded Plastic | Sn/Pb Solder | MSL1 ^[1] | H390 XXXX |
| HMC390LP4E | RoHS-compliant Low Stress Injection Molded Plastic | 100% matte Sn | MSL1 ^[2] | H390 XXXX |



[1] Max peak reflow temperature of 235 °C

[2] Max peak reflow temperature of 260 °C

[3] 4-Digit lot number XXXX

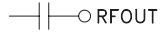
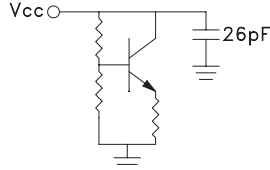
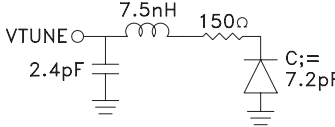

Pin Descriptions

| Pin Number | Function | Description | Interface Schematic |
|-------------------------------|----------|---|---|
| 1- 14, 17 - 19, 21, 23, 24 | N/C | No Connection | |
| 15 | GND | This pin must be connected to RF & DC ground. |  |
| 16 | RFOUT | RF output (AC coupled) |  |
| 20 | Vcc | Supply Voltage Vcc= 3V |  |
| 22 | VTUNE | Control Voltage Input. Modulation port bandwidth dependent on drive source impedance. |  |
| | GND | Package bottom has an exposed metal paddle that must be RF & DC grounded. |  |

Evaluation PCB

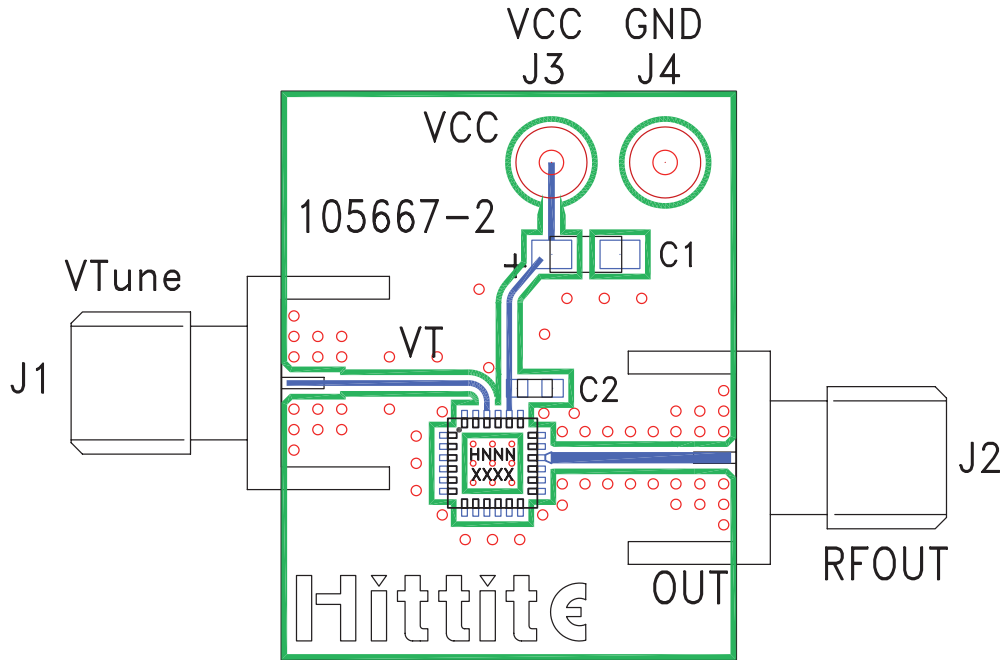

List of Materials for Evaluation PCB 105706 [1]

| Item | Description |
|---------|--------------------------------|
| J1 - J2 | PCB Mount SMA RF Connector |
| J3 - J4 | DC Pin |
| C1 | 4.7 μ F Tantalum Capacitor |
| C2 | 10,000 pF Capacitor, 0603 Pkg. |
| U1 | HMC390LP4 / HMC390LP4E VCO |
| PCB* | 105667 Eval Board |

[1] Reference this number when ordering complete evaluation PCB

[2] Circuit Board Material: Rogers 4350

The circuit board used in the final application should use RF circuit design techniques. Signal lines should have 50 ohm impedance while the package ground leads and exposed paddle should be connected directly to the ground plane similar to that shown. A sufficient number of via holes should be used to connect the top and bottom ground planes. The evaluation circuit board shown is available from Hittite upon request.



Notes: