

BRIGHT LED ELECTRONICS CORP.

LED LAMPS SPECIFICATION

● COMMODITY : AXIAL TYPE LAMP

● DEVICE NUMBER : BL-XG6361-F9

PAGE: 2

● ELECTRICAL AND OPTICAL CHARACTERISTICS (Ta=25°C)

VERSION: 1.0

| Chip | | | Lens Appearance | Absolute Maximum Rating | | | | Electro-optical Data (At 20mA) | | | | Viewing Angle 2θ 1/2 (deg) |
|---------------|------------------------------|----------------------------------|--------------------|-------------------------|---------|---------|--------------|--------------------------------|------|----------|-------|----------------------------------|
| Emitted Color | Peak Wave Length λ p (nm) | Dominant Wave Length λ d (nm) | | Δ λ (nm) | Pd (mW) | If (mA) | Peak If (mA) | Vf (V) | | Iv (mcd) | | |
| | | | | | | | | Typ. | Max. | Min. | Typ. | |
| Green | 525 | 525±5 | Water Clear | 35 | 120 | 30 | 100 | 3.5 | 4.0 | 94.0 | 300.0 | 35 |

Remark : Viewing angle is the Off-axis angle at which the luminous intensity is half the axial luminous intensity.

● ABSOLUTE MAXIMUM RATINGS (Ta=25°C)

| | |
|-----------------------------------|---------------------|
| Reverse Voltage | 5V |
| Reverse Current (VR=5V) | 100μA |
| Operating Temperature Range | -25°C ~ 80°C |
| Storage Temperature Range | -30°C ~ 85°C |
| Lead Soldering Temperature | 260°C For 5 Seconds |

● PACKAGE DIMENSIONS

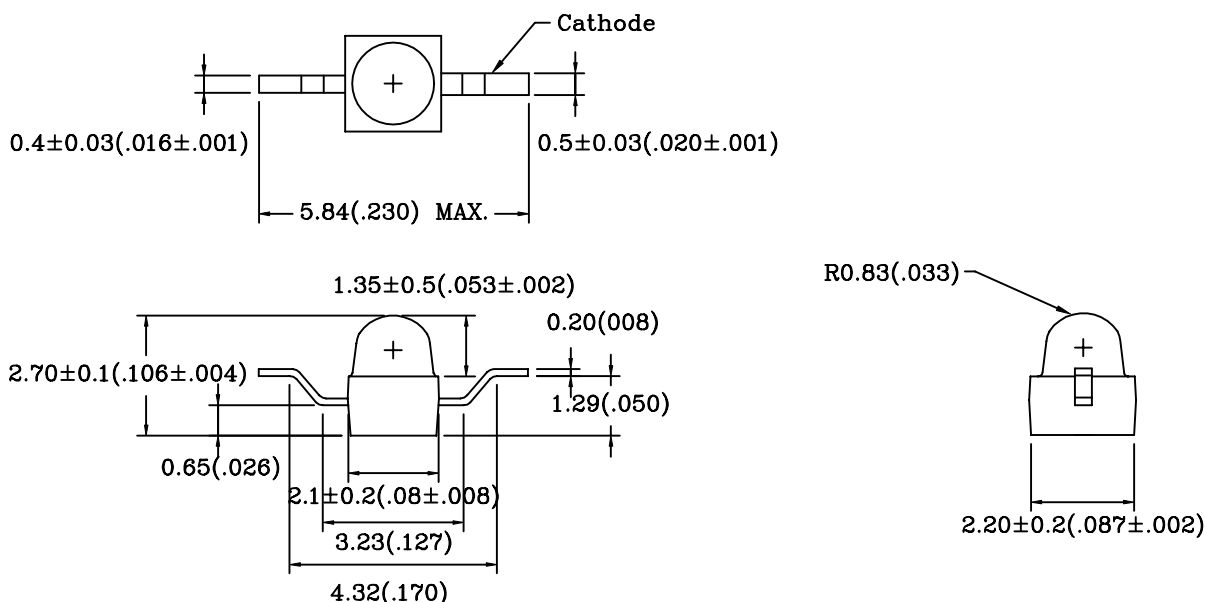

NOTES: 1.All dimensions are in millimeters (inches).

2.Tolerance is ± 0.25mm (0.01") unless otherwise specified.

3.Lead spacing is measured where the leads emerge from the package.

4.Specifications are subject to change without notice.

BRIGHT LED ELECTRONICS CORP.

LED LAMP SPECIFICATION

●COMMODITY : AXIAL TYPE LED LAMP

●DEVICE NUMBER : BL-XG6361-F9

●ELECTRICAL AND OPTICAL CHARACTERISTICS (Ta=25°C)

PAGE: 3

REVISION: 1.0

Fig.1 RELATIVE INTENSITY VS. WAVELENGTH

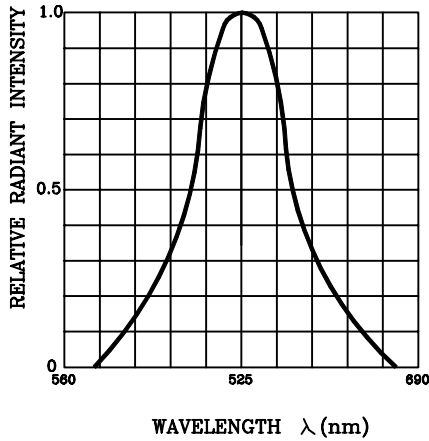

Fig.2 FORWARD CURRENT DERATING CURVE

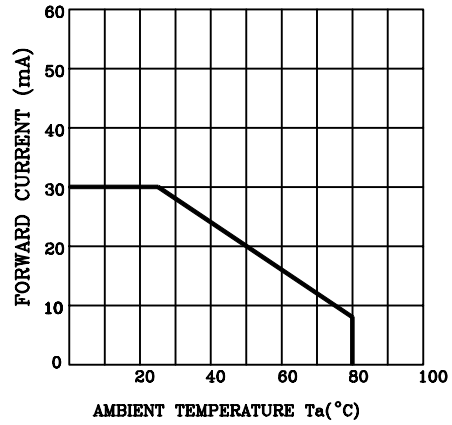

Fig.3 FORWARD CURRENT VS. FORWARD VOLTAGE

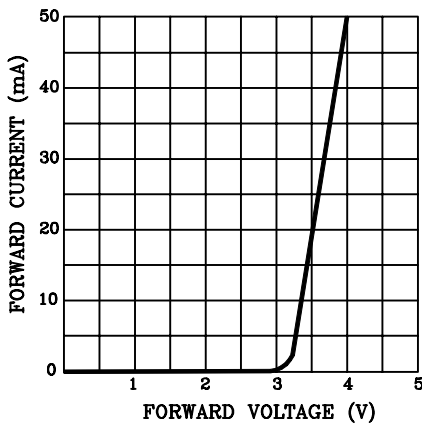

Fig.4 RELATIVE LUMINOUS INTENSITY VS. AMBIENT TEMPERATURE

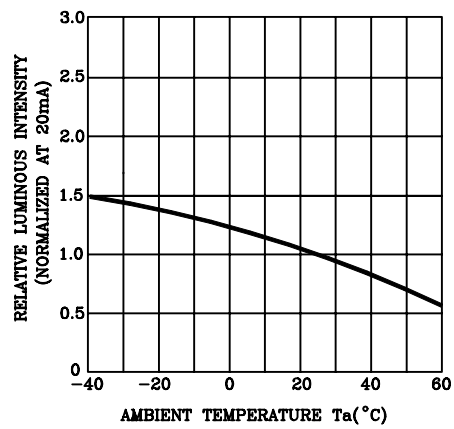

Fig.5 RELATIVE LUMINOUS INTENSITY VS. FORWARD CURRENT

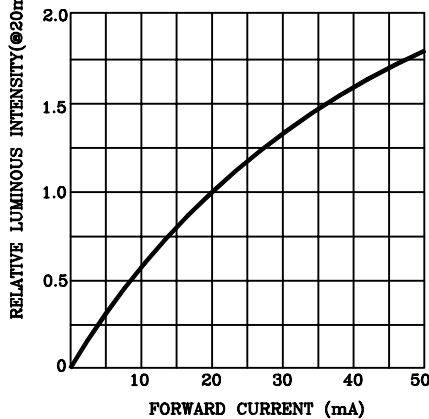
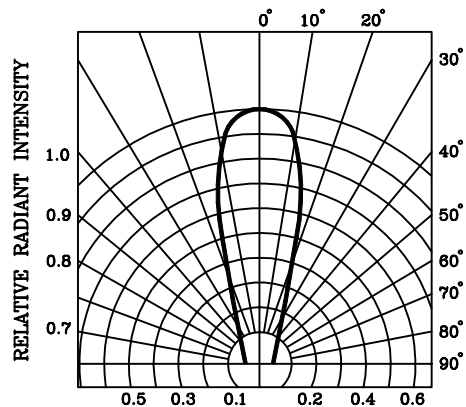

Fig.6 RADIATION DIAGRAM



BRIGHT LED ELECTRONICS CORP.

AXIAL LED LAMP SPECIFICATION

● COMMODITY : AXIAL TYPE LED LAMP

● DEVICE NUMBER : BL-XG6361-TR9

PAGE: 4

● TAPPING AND PACKAGING SPECIFICATION

REVISION: 1.0

| ITEM | SYMBOL | SPECIFICATION | | | |
|------------------------------------------|--------|---------------|-------|---------|-------|
| | | Minimum | | Maximum | |
| | | mm | inch | mm | inch |
| Tape Feed Hole Diameter (DIA) | D_0 | 1.40 | 0.055 | 1.55 | 0.061 |
| Feed Hole Location | E | 1.65 | 0.065 | 1.85 | 0.072 |
| Centers Line Dimensions Length Direction | F | 5.45 | 0.215 | 5.55 | 0.218 |
| Compartment Depth | K_0 | 2.10 | 0.083 | 2.15 | 0.084 |
| Carrier Tape Overall Thickness | K | 3.00 | 0.118 | 3.20 | 0.126 |
| Compartment Pitch | P | 3.90 | 0.153 | 4.10 | 0.161 |
| Sprocket Hole Diameter | P_0 | 3.90 | 0.153 | 4.10 | 0.161 |
| Centers Line Dimensions Length Direction | P_2 | 1.95 | 0.076 | 2.05 | 0.080 |
| Carrier Tape Thickness | t | — | — | 0.30 | 0.012 |
| Carrier Tape Width | W | 12.00 | 0.472 | 12.30 | 0.484 |
| Flange Diameter | A | 178.0 | 7.008 | 180.0 | 7.087 |
| Hub Spindle Hole | C | 12.50 | 0.492 | 13.50 | 0.531 |
| Hub Diameter | D_2 | 20.00 | 0.788 | 21.50 | 0.846 |
| Fixing Tape Width | W_1 | 9.00 | 0.354 | 9.30 | 0.366 |
| Flange Space Between Flanges | T | 16.00 | 0.629 | 17.00 | 0.669 |
| Compartment Length | A_0 | 1.87 | 0.074 | .07 | 0.081 |
| Compartment Width | B_0 | 6.30 | 0.248 | 6.50 | 0.256 |

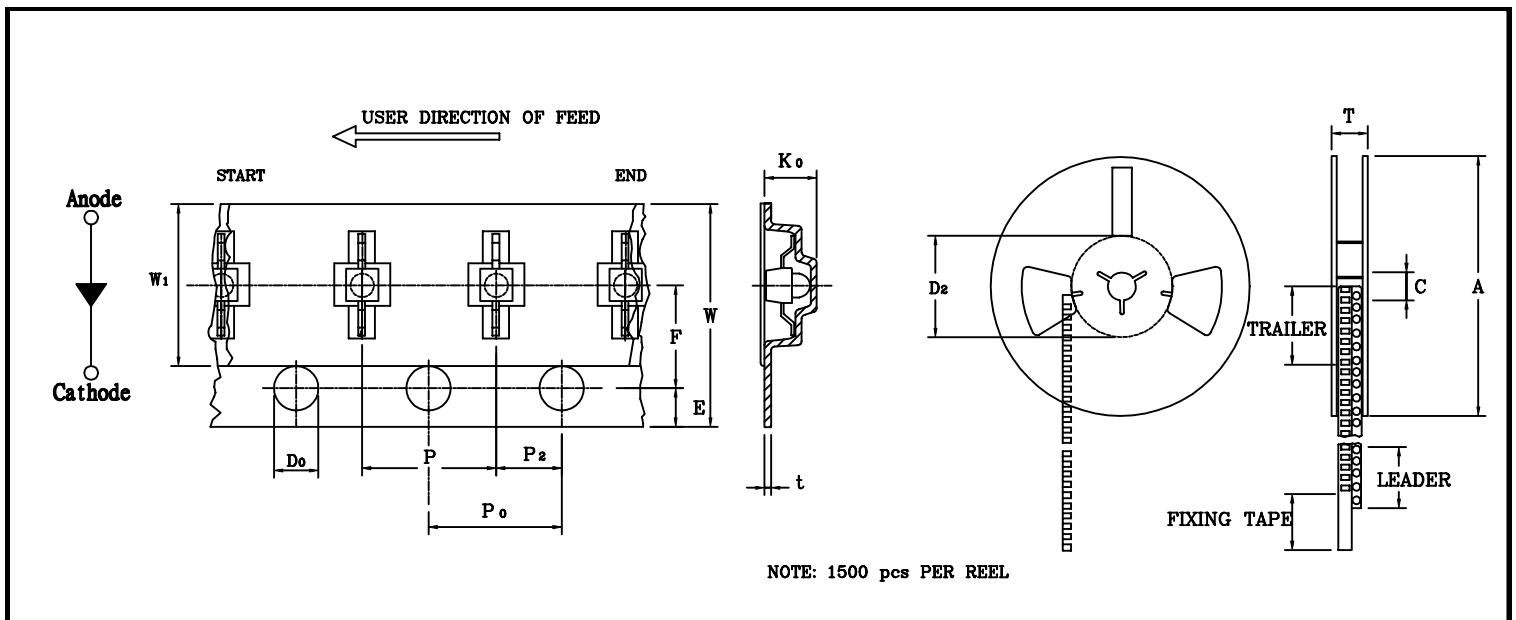

BRIGHT LED ELECTRONICS CORP.

SURFACE MOUNT CHIP LED LAMP SPECIFICATION

RELIABILITY TEST

PAGE: 5

REVISION: 1.0

| Classification | Test Item | Reference Standard | Test Conditions | Result |
|--------------------|----------------------------------------|-----------------------------------------------------------------------------|------------------------------------------------------------------------------------------------------------------------------------------------------------|--------|
| Endurance Test | Operation Life | MIL-STD-750:1026 MIL-STD-883:1005 JIS C 7021 :B-1 | Connect with a power $I_f=20\text{mA}$ T_a =Under room temperature Test time=1,000hrs | 0/20 |
| | High Temperature High Humidity Storage | MIL-STD-202:103B JIS C 7021 :B-11 | $T_a=+65^\circ\text{C}\pm 5^\circ\text{C}$ RH=90%-95% Test time=240hrs | 0/20 |
| | High Temperature Storage | MIL-STD-883:1008 JIS C 7021 :B-10 | High $T_a=+85^\circ\text{C}\pm 5^\circ\text{C}$ Test time=1,000hrs | 0/20 |
| | Low Temperature Storage | JIS-C-7021 :B-12 | Low $T_a=-35^\circ\text{C}\pm 5^\circ\text{C}$ Test time=1,000hrs | 0/20 |
| Environmental Test | Temperature Cycling | MIL-STD-202:107D MIL-STD-750:1051 MIL-STD-883:1010 JIS C 7021 :A-4 | $-35^\circ\text{C} \sim +25^\circ\text{C} \sim +85^\circ\text{C} \sim +25^\circ\text{C}$ 60min 20min 60min 20min Test Time=5cycle | 0/20 |
| | Thermal Shock | MIL-STD-202:107D MIL-STD-750:1051 MIL-STD-883:1011 | $-35^\circ\text{C}\pm 5^\circ\text{C} \sim +85^\circ\text{C}\pm 5^\circ\text{C}$ 20min 20min Test Time=10cycle | 0/20 |
| | Solder Resistance | MIL-STD-202:201A MIL-STD-750:2031 JIS C 7021 :A-1 | Preheating : $140^\circ\text{C} - 160^\circ\text{C}$, within 2 minutes. Operation heating : 235°C (Max.), within 10seconds. (Max.) | 0/20 |

JUDGMENT CRITERIA OF FAILURE FOR THE RELIABILITY

| Measuring items | Symbol | Measuring conditions | Judgement criteria for failure |
|--------------------|-------------------------|----------------------|--------------------------------|
| Forward voltage | V_F (V) | $I_f=20\text{mA}$ | Over $U_x1.2$ |
| Reverse current | I_r (μA) | $V_r=5\text{V}$ | Over U_x2 |
| Luminous intensity | I_v (mcd) | $I_f=20\text{mA}$ | Below $SX0.5$ |

Note: 1.U means the upper limit of specified characteristics. S means initial value.

2.Measurment shall be taken between 2 hours and after the test pieces have been returned to normal ambient conditions after completion of each test.

BRIGHT LED ELECTRONICS CORP.

SURFACE MOUNT CHIP LED LAMP SPECIFICATION

PAGE: 6

REVISION: 1.0

1. SOLDERING:

● Manual Of Soldering

The temperature of the iron tip should not be higher than 300°C (572°F) and Soldering within 3 seconds per solder-land is to be observed.

● Reflow Soldering

Preheating : 140°C~160°C±5°C, within 2 minutes.

Operation heating : 235°C (MAX.) within 10 seconds.(Max)

Gradual Cooling (Avoid quenching).

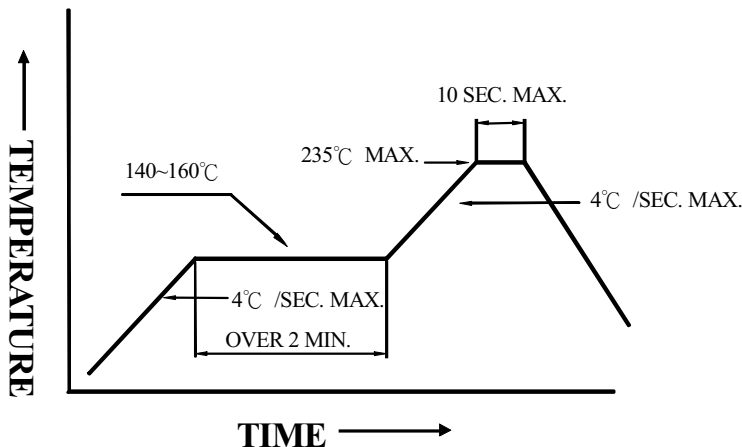

● DIP soldering (Wave Soldering)

Preheating : 120°C~150°C, within 120~180 sec.

Operation heating : 245°C±5°C within 5 sec. 260°C (Max)

Gradual Cooling (Avoid quenching).

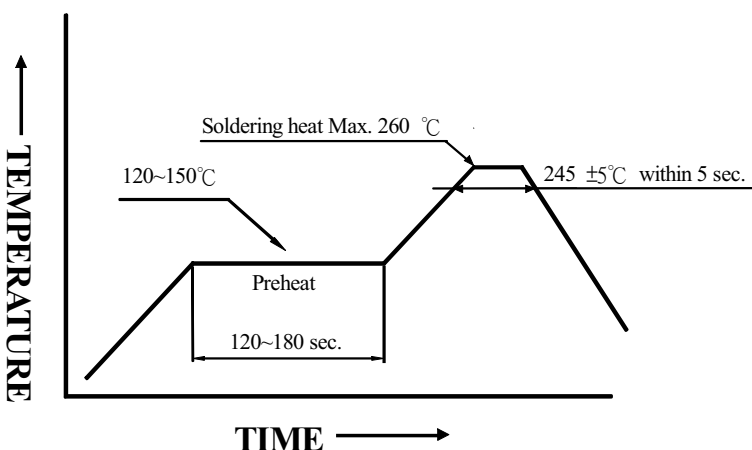

2. Handling :

Care must be taken not to cause to the epoxy resin portion of BRIGHT LEDs while it is exposed to high temperature.

Care must be taken not rub the epoxy resin portion of BRIGHT LEDs with hard or sharp article such as the sand blast and the metal hook.

BRIGHT LED ELECTRONICS CORP.

SURFACE MOUNT CHIP LED LAMP SPECIFICATION

PAGE: 7

REVISION: 1.0

3. Notes for designing:

Care must be taken to provide the current limiting resistor in the circuit so as to drive the BRIGHT LEDs within the rated figures. Also, caution should be taken not to overload BRIGHT LEDs with instantaneous voltage at the turning ON and OFF of the circuit.

When using the pulse drive care must be taken to keep the average current within the rated figures. Also, the circuit should be designed so as to be subjected to reverse voltage when turning off the BRIGHT LEDs.

4. Storage:

In order to avoid the absorption of moisture, it is recommended to solder BRIGHT LEDs as soon as possible after unpacking the sealed envelope.

If the envelope is still packed, to store it in the environment as following:

(1) Temperature : 5°C-30°C (41°F) Humidity : RH 60% Max.

(2) After this bag is opened, devices that will be applied to infrared reflow, vapor-phase reflow, or equivalent soldering process must be:

a. Completed within 24 hours.

b. Stored at less than 30% RH.

(3) Devices require baking before mounting, if:

(2) a or (2) b is not met.

(4) If baking is required, devices must be baked under below conditions:
12 hours at 60°C ± 3°C.

5. Package and Label of Products:

(1) Package: Products are packed in one bag of 3000 pcs (one taping reel) and a label is attached on each bag.

(2) Label:

