

TOSHIBA Bipolar Linear Integrated Circuit Silicon Monolithic

TA8200AH

Dual Audio Power Amplifier

The TA8200AH is dual audio power amplifier for consumer applications.

This IC provides an output power of 13 watts per channel (at $V_{CC} = 28\text{ V}$, $f = 1\text{ kHz}$, $\text{THD} = 10\%$, $R_L = 8\ \Omega$).

It is suitable for power amplifier of TV and home stereo.

Features

- High output power: $P_{\text{out}} = 13\text{ W/channel (Typ.)}$
($V_{CC} = 28\text{ V}$, $R_L = 8\ \Omega$, $f = 1\text{ kHz}$, $\text{THD} = 10\%$)
- Low noise: $V_{\text{no}} = 0.14\text{ mVrms (Typ.)}$
($V_{CC} = 28\text{ V}$, $R_L = 8\ \Omega$, $G_V = 34\text{ dB}$, $R_g = 10\text{ k}\Omega$,
 $\text{BW} = 20\text{ Hz}\sim 20\text{ kHz}$)
- Very few external parts
- Built in audio muting circuit
- Built in thermal shut down protector circuit
- Operating supply voltage range: $V_{CC(\text{opr})} = 10\sim 37\text{ V}$ ($T_a = 25^\circ\text{C}$)

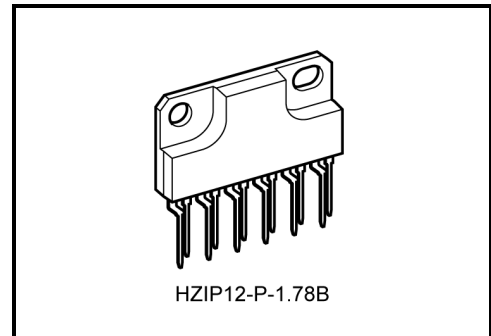

HZIP12-P-1.78B

Weight: 4.04 g (typ.)

Block Diagram

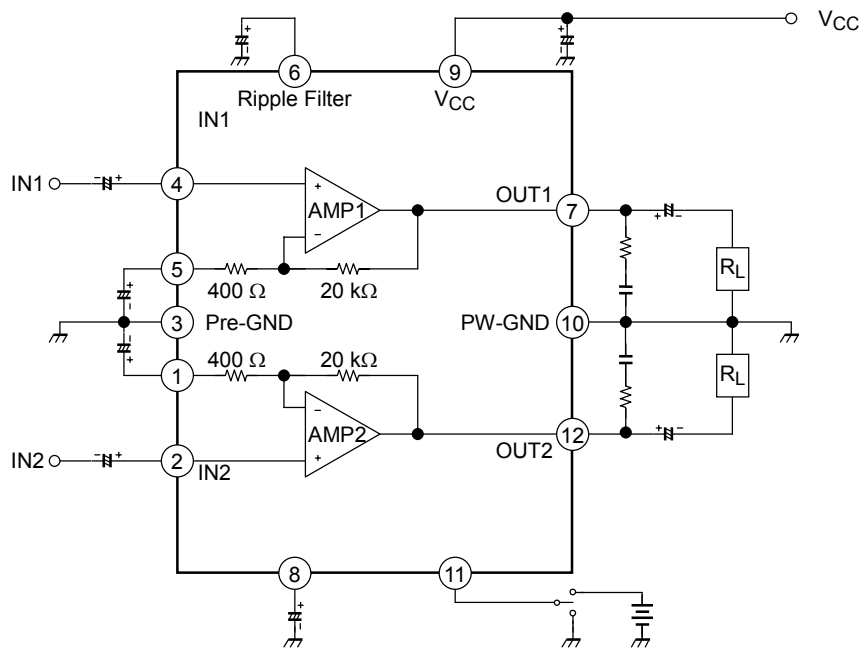

Application Information

1. Voltage gain

The closed loop voltage gain is determined by R₁, R₂.

$$G_V = 20 \log \frac{R_1 + R_2}{R_2} \text{ (dB)}$$

$$= 20 \log \frac{20 \text{ k}\Omega + 400 \Omega}{400 \Omega} = 34 \text{ (dB)}$$

$$= 34 \text{ (dB)}$$

Amplifier with gain < 34dB

$$G_V = 20 \log \frac{R_1 + R_2 + R_3}{R_2 + R_3} \text{ (dB)}$$

When R₃ = 220 Ω
 G_V ≈ 30 (dB)
 is given.

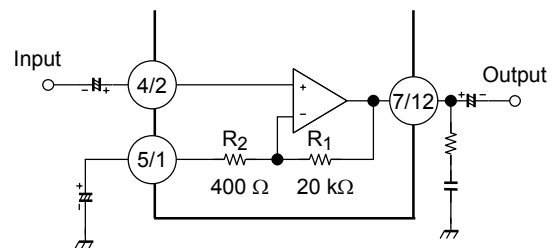

Figure 1

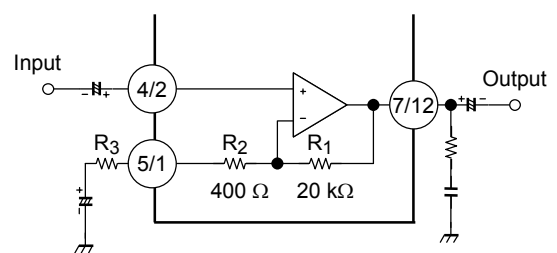

Figure 2

2. Muting

(1) Audio muting

This IC is possible to make audio muting operation by using 11 pin muting terminal. In Fig. 3, the equivalent circuit in the muting circuit section is shown.

By means of reducing the voltage of 11 pin down to 2.8 V or less in Fig. 3, Q₁ is turned ON and the base voltage of Q₂ in the differential circuit fabricated with Q₂ and Q₃.

Therefore, with the voltage reduction of 11 pin, the input circuits of dummy of input terminal and that in the dotted line operate and cut-off the input signal.

After muting, the bias circuit continues is operation and the power supply current of quiescent time.

8 pin, the capacitor terminal for reducing the pop noise can reduce the pop noise through making the time constant longer by means of inserting the capacitor extarnary.

In the care this terminal is not used, short 8 pin with 11 pin.

The voltage of 11 pin set up to 4 V or more.

(2) IC internal muting at VCC OFF

When VCC = 8 V or less at VCC off, the detection circuit at VCC off is operated. And the base voltage of Q₁ is reduced and the muting operation is mode.

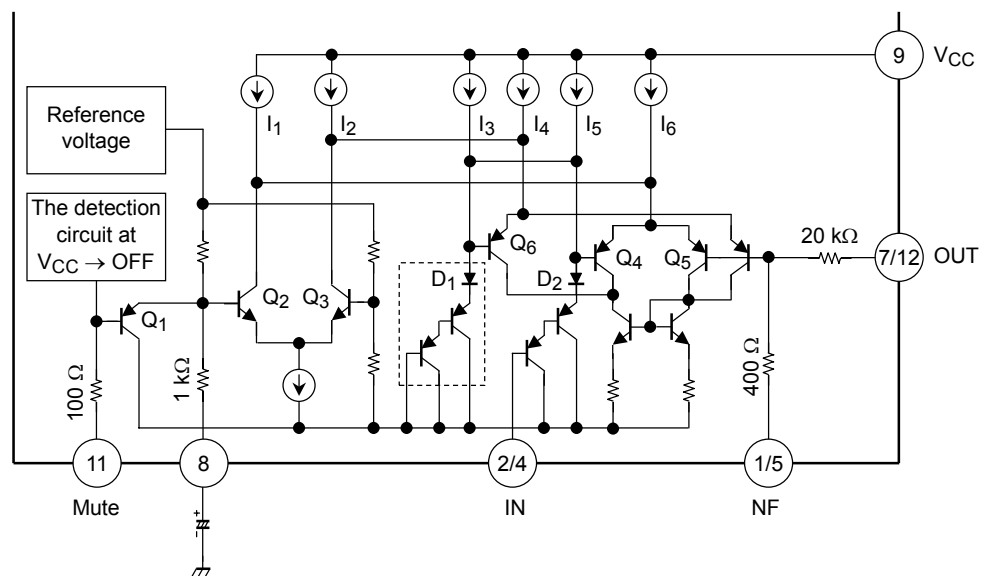
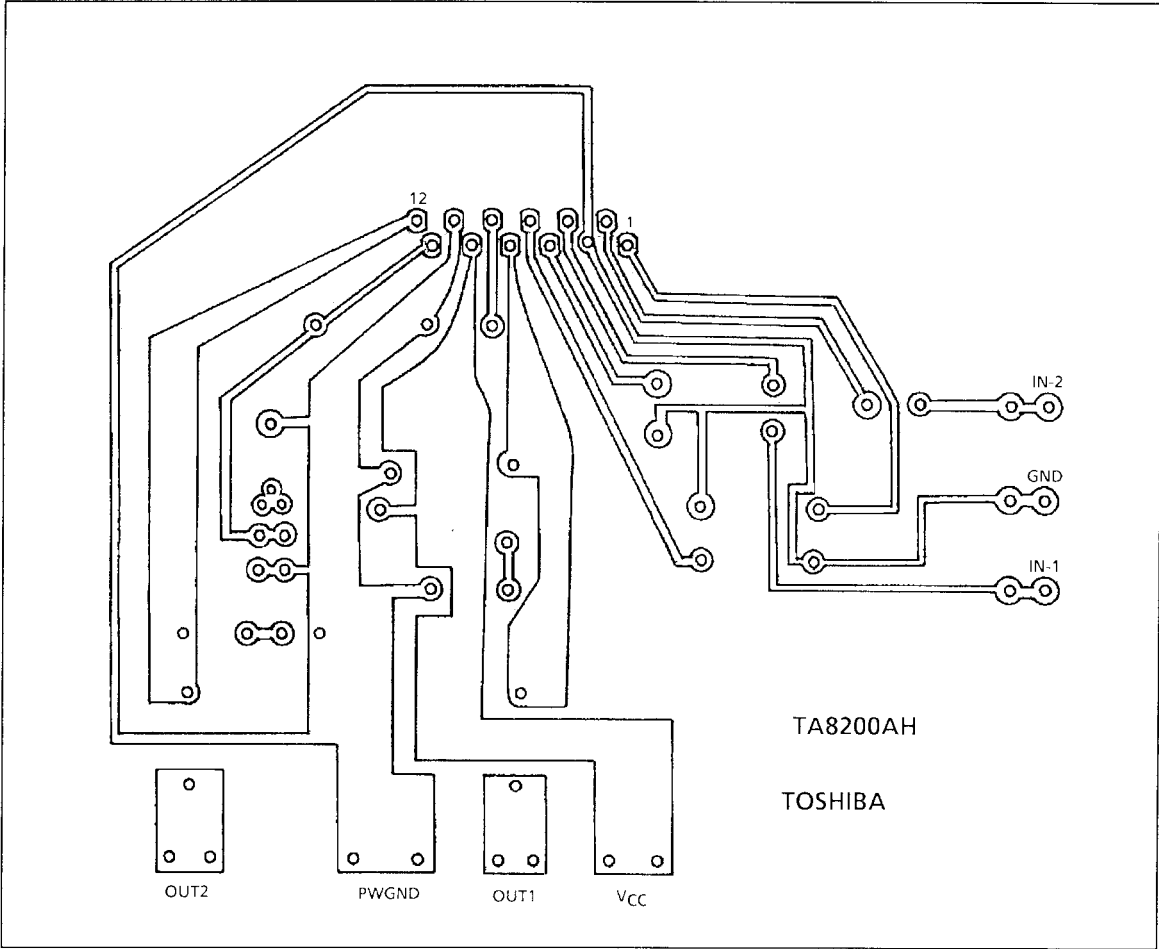

Figure 3

Cautions

This IC is not proof enough against a strong E-M field by CRT which may cause malfunction such as leak. Please set the IC keeping the distance from CRT.

Standard PCB



(Bottom view)

Maximum Ratings (Ta = 25°C)

Characteristics	Symbol	Rating	Unit
Supply voltage	V _{CC}	37	V
Output current (Peak/ch)	I _{O (peak)}	2.5	A
Power dissipation	P _{D (Note)}	25	W
Operating temperature	T _{opr}	-20~75	°C
Storage temperature	T _{stg}	-55~150	°C

Note: Derated above Ta = 25°C in the proportion of 200 mW/°C.

Electrical Characteristics

(unless otherwise specified, V_{CC} = 28 V, R_L = 8 Ω, R_g = 600 Ω, f = 1 kHz, Ta = 25°C)

Characteristics	Symbol	Test Circuit	Test Condition	Min	Typ.	Max	Unit
Quiescent current	I _{CCQ}	—	V _{in} = 0	—	50	105	mA
Output power	P _{out (1)}	—	THD = 10%	10	13	—	W
	P _{out (2)}	—	THD = 1%	—	10	—	
Total harmonic distortion	THD	—	P _{out} = 2 W	—	0.04	0.2	%
Voltage gain	G _V	—	V _{out} = 0.775 Vrms (0dBm)	32.5	34.0	35.5	dB
Input resistance	R _{IN}	—	—	—	30	—	kΩ
Ripple rejection ratio	R.R.	—	R _g = 0, f _{ripple} = 100 Hz V _{ripple} = 0.775 Vrms (0dBm)	-40	-50	—	dB
Output noise voltage	V _{no}	—	R _g = 10 kΩ, BW = 20 Hz~20 kHz	—	0.14	0.3	mVrms
Cross talk	C.T.	—	R _g = 10 kΩ, V _{out} = 0.775 Vrms (0dBm)	—	-70	—	dB
Muting threshold voltage	V _{th 11}	—	—	2.6	2.8	—	V

Typ. DC Voltage of Each Terminal (V_{CC} = 28 V, Ta = 25°C)

Terminal No.	1	2	3	4	5	6	7	8	9	10	11	12
DC voltage (V)	1.6	20m	GND	20m	1.6	9.4	13.0	5.0	V _{CC}	GND	2.8	13.0

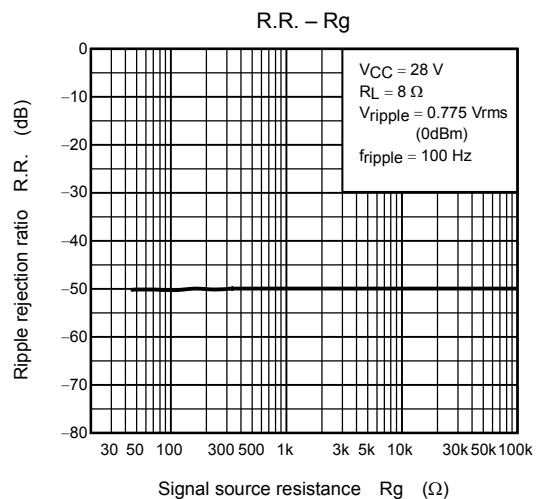
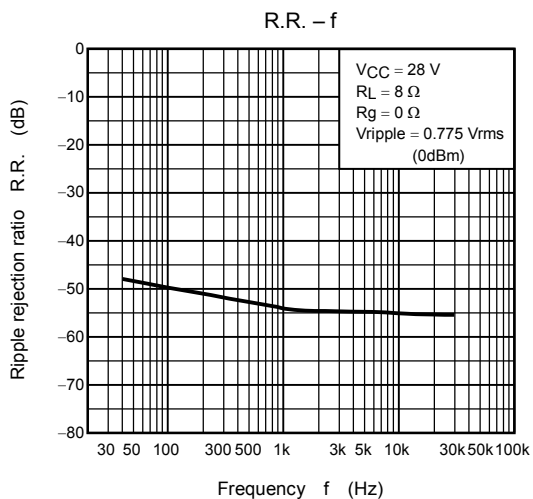
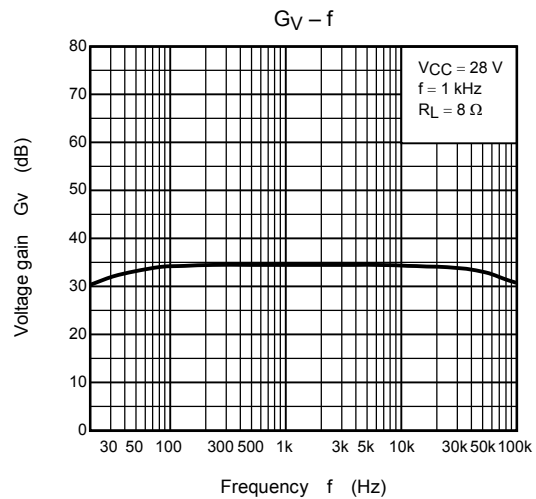
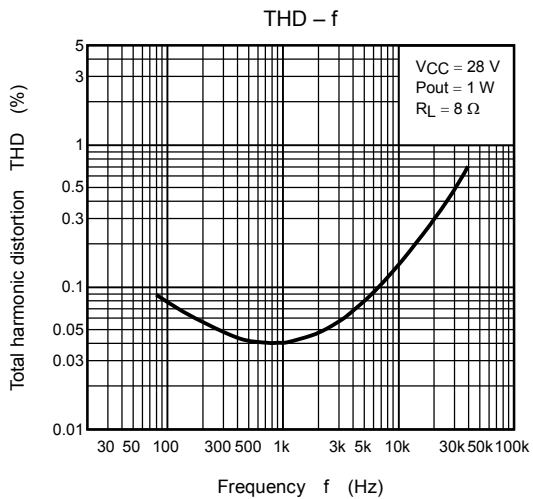
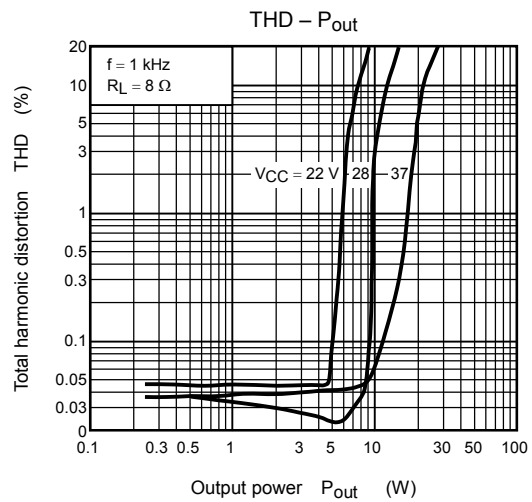
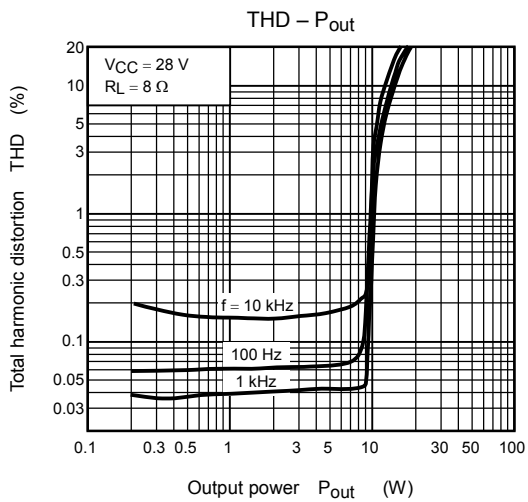

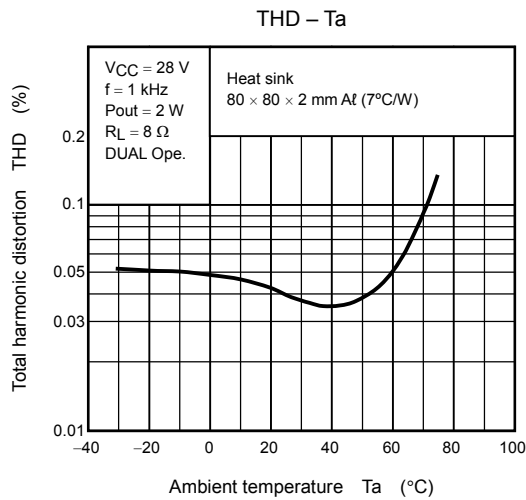
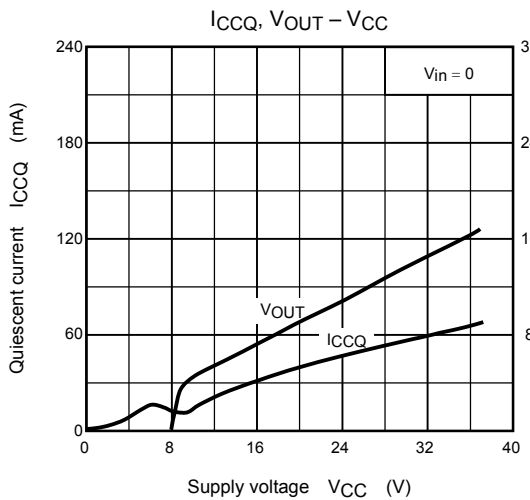
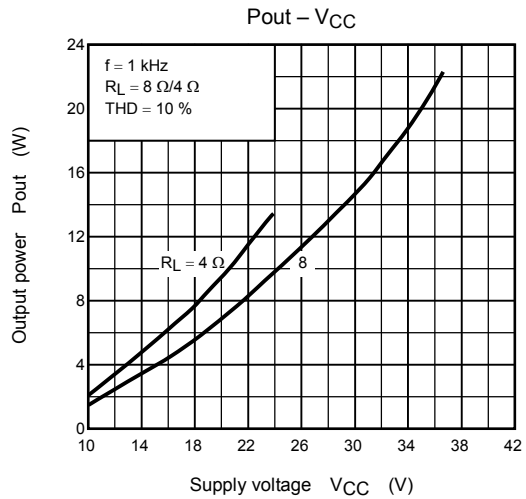
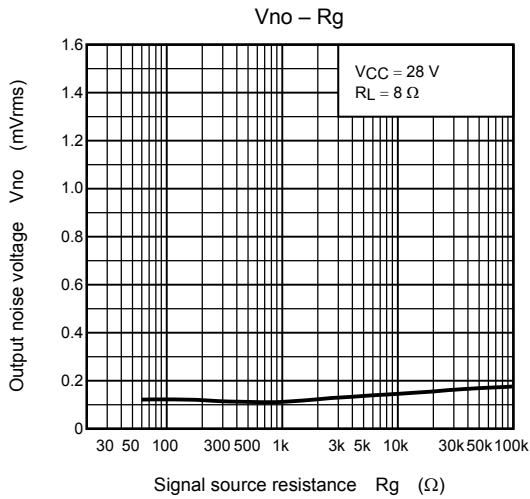
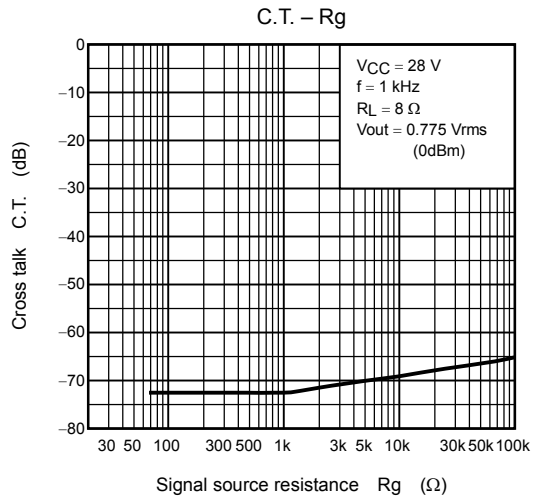
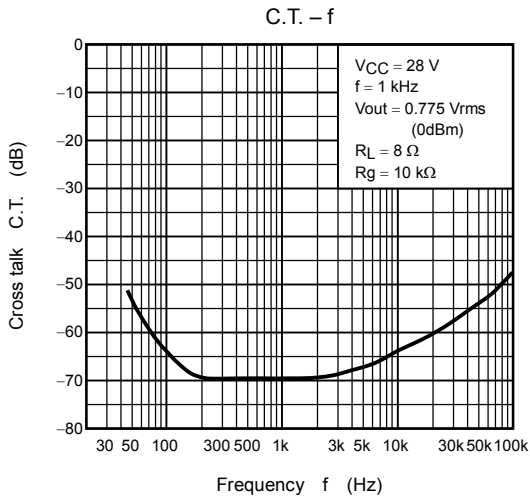

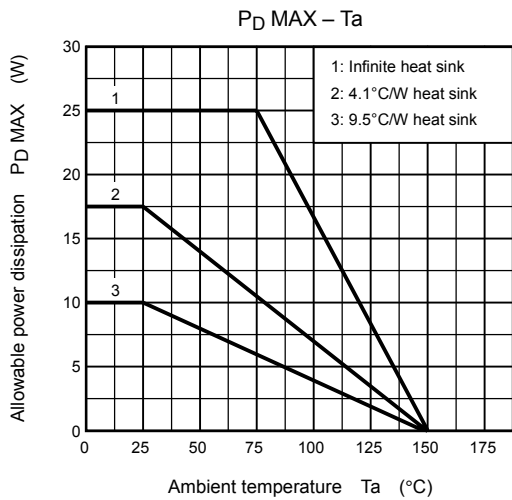
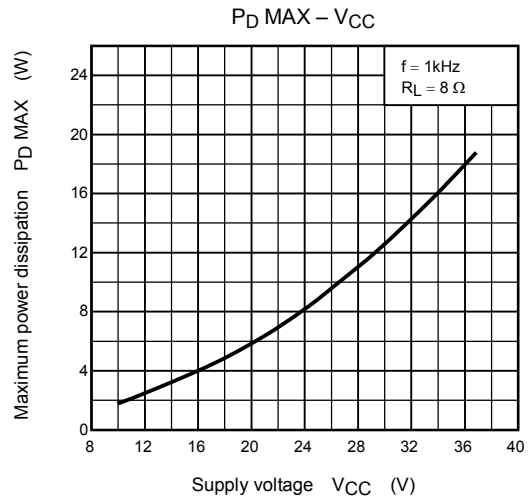
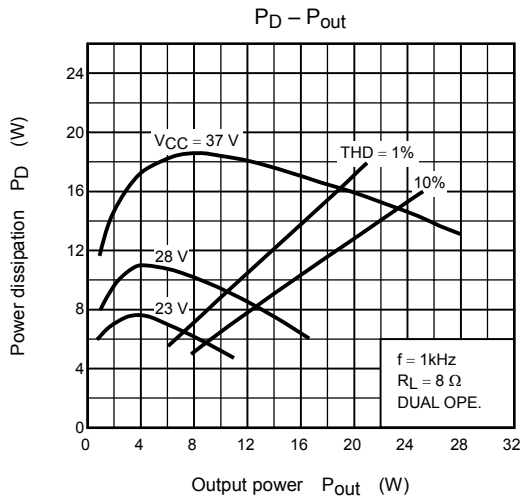
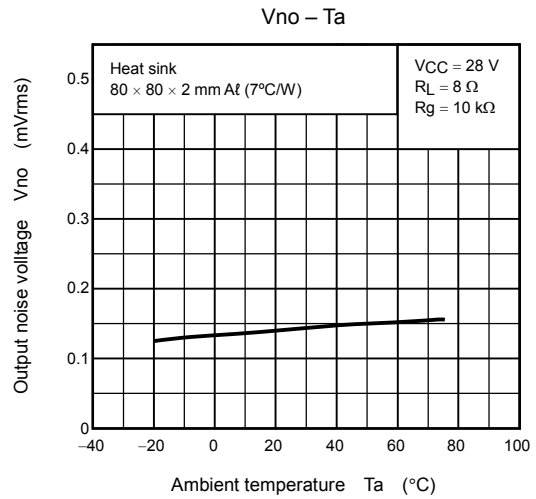
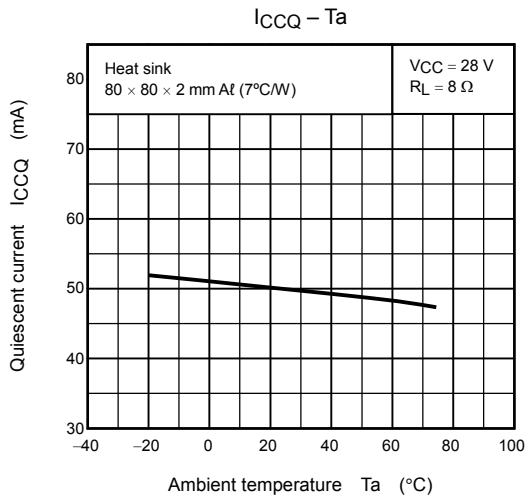

Package Dimensions

HZIP12-P-1.78B

Unit: mm

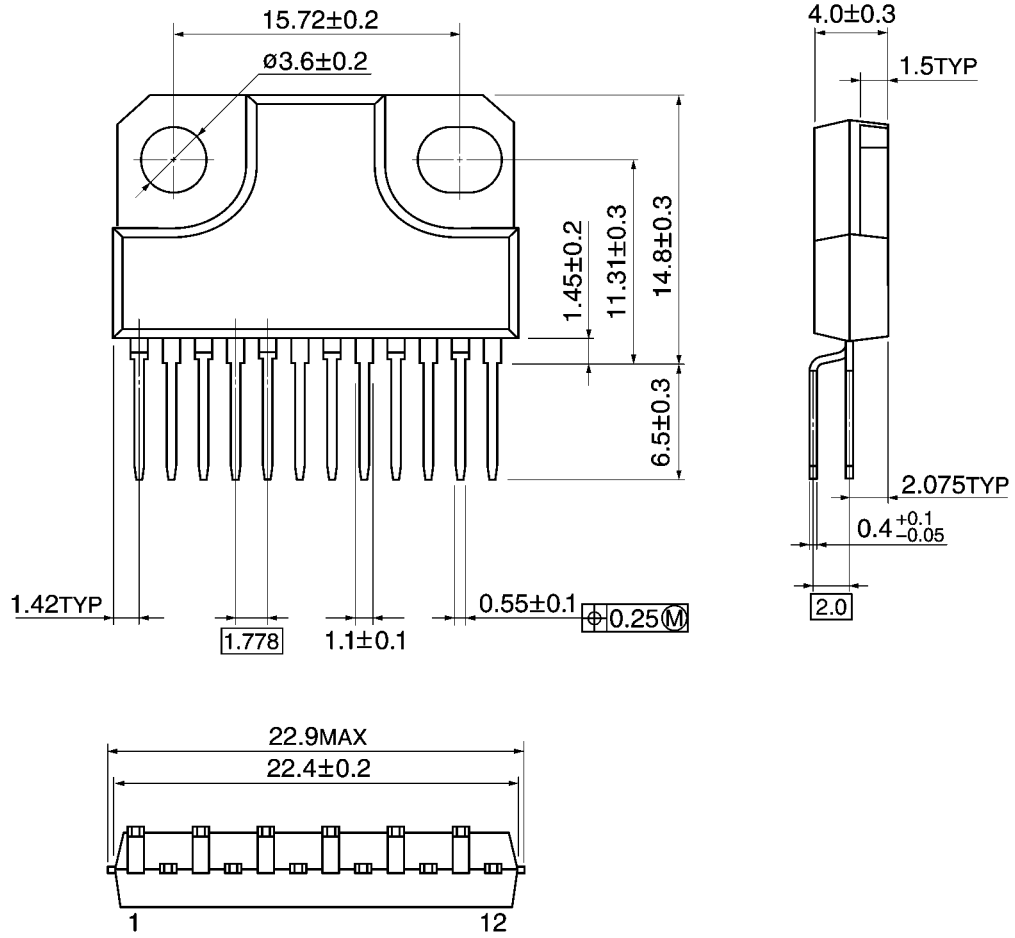

Weight: 4.04 g (typ.)

RESTRICTIONS ON PRODUCT USE

000707EBF

- TOSHIBA is continually working to improve the quality and reliability of its products. Nevertheless, semiconductor devices in general can malfunction or fail due to their inherent electrical sensitivity and vulnerability to physical stress. It is the responsibility of the buyer, when utilizing TOSHIBA products, to comply with the standards of safety in making a safe design for the entire system, and to avoid situations in which a malfunction or failure of such TOSHIBA products could cause loss of human life, bodily injury or damage to property.
In developing your designs, please ensure that TOSHIBA products are used within specified operating ranges as set forth in the most recent TOSHIBA products specifications. Also, please keep in mind the precautions and conditions set forth in the "Handling Guide for Semiconductor Devices," or "TOSHIBA Semiconductor Reliability Handbook" etc..
- The TOSHIBA products listed in this document are intended for usage in general electronics applications (computer, personal equipment, office equipment, measuring equipment, industrial robotics, domestic appliances, etc.). These TOSHIBA products are neither intended nor warranted for usage in equipment that requires extraordinarily high quality and/or reliability or a malfunction or failure of which may cause loss of human life or bodily injury ("Unintended Usage"). Unintended Usage include atomic energy control instruments, airplane or spaceship instruments, transportation instruments, traffic signal instruments, combustion control instruments, medical instruments, all types of safety devices, etc.. Unintended Usage of TOSHIBA products listed in this document shall be made at the customer's own risk.
- This product generates heat during normal operation. However, substandard performance or malfunction may cause the product and its peripherals to reach abnormally high temperatures.
The product is often the final stage (the external output stage) of a circuit. Substandard performance or malfunction of the destination device to which the circuit supplies output may cause damage to the circuit or to the product.
- The products described in this document are subject to the foreign exchange and foreign trade laws.
- The information contained herein is presented only as a guide for the applications of our products. No responsibility is assumed by TOSHIBA CORPORATION for any infringements of intellectual property or other rights of the third parties which may result from its use. No license is granted by implication or otherwise under any intellectual property or other rights of TOSHIBA CORPORATION or others.
- The information contained herein is subject to change without notice.