



■ Features :

- AC 180~260VAC input
- PF> 0.98@ 230VAC
- Protections: Short circuit/ Overload/ Over voltage/ Over temperature
- Built in remote sense function
- Built-in remote ON-OFF control
- Power good signal
- With parallel function(N+1)
- Can adjust from 20~100% output voltage by external control 1-5V
- Forced air cooling by built-in fan
- 3 years warranty



SPECIFICATION

ORDER NO.	SCP-600-05	SCP-600-09	SCP-600-12	SCP-600-15	SCP-600-18	SCP-600-24	SCP-600-36	SCP-600-48	SCP-600-60	
OUTPUT	SAFETY MODEL NO.	600S-P005	600S-P009	600S-P012	600S-P015	600S-P018	600S-P024	600S-P036	600S-P048	600S-P060
	DC VOLTAGE	5V	9V	12V	15V	18V	24V	36V	48V	60V
	RATED CURRENT	100A	66A	50A	40A	33A	25A	16A	12A	10A
	CURRENT RANGE	0 ~ 100A	0 ~ 66A	0 ~ 50A	0 ~ 40A	0 ~ 33A	0 ~ 25A	0 ~ 16A	0 ~ 12A	0 ~ 10A
	RATED POWER	500W	594W	600W	600W	600W	600W	500W	576W	600W
	RIPPLE & NOISE (max.) Note.2	100mVp-p	100mVp-p	120mVp-p	150mVp-p	180mVp-p	240mVp-p	360mVp-p	480mVp-p	500mVp-p
	VOLTAGE ADJ. RANGE	±5.0% Typical adjustment by potentiometer 20%~100% adjustment by 1~5VDC external control								
	VOLTAGE TOLERANCE Note.3	±1.5%	±1.0%	±1.0%	±1.0%	±1.0%	±1.0%	±1.0%	±1.0%	±1.0%
	LINE REGULATION	±0.5%	±0.5%	±0.5%	±0.5%	±0.5%	±0.5%	±0.5%	±0.5%	±0.5%
	LOAD REGULATION	±1.0%	±0.5%	±0.5%	±0.5%	±0.5%	±0.5%	±0.5%	±0.5%	±0.5%
SETUP, RISE, HOLD TIME	500ms, 250ms, 16ms at full load									
INPUT	VOLTAGE RANGE	180~260VAC 260~370VDC see the derating curve								
	FREQUENCY RANGE	47~63Hz								
	POWER FACTOR	>0.98 / 230VAC								
	EFFICIENCY (Typ.)	80%	82%	84%	85%	86%	89%	89%	90%	90%
	AC CURRENT	5.0A / 230VAC								
	INRUSH CURRENT (max.)	60A / 230VAC								
LEAKAGE CURRENT (max.)	3.5mA / 240VAC									
PROTECTION	OVER LOAD Note.4	105~115% rated output power Protection type : Current limiting, delay shut down o/p voltage, re-power on to recover								
	OVER VOLTAGE	110 ~ 135% Follow to output set up point Protection type : Shut down o/p voltage, re-power on to recover								
	OVER TEMPERATURE	>100°C / measure by heat sink, near transformer Protection type : Shut down o/p voltage, recovers automatically after temperature goes down								
ENVIRONMENT	WORKING TEMP.	-20~+65°C (Refer to output load derating curve)								
	WORKING HUMIDITY	20~90% RH non-condensing								
	STORAGE TEMP., HUMIDITY	-20~+85°C 10~95% RH								
	TEMP. COEFFICIENT	±0.04% / °C (0~50°C)								
SAFETY & EMC (Note. 5)	VIBRATION	10~200Hz, 2G 10min./1cycle, 60min. each along X, Y, Z axes								
	SAFETY STANDARDS	UL60950, TUV EN60950 Approved								
	WITHSTAND VOLTAGE	I/P-O/P:3KVAC I/P-FG:1.5KVAC O/P-FG:0.5KVAC								
	ISOLATION RESISTANCE	I/P-O/P, I/P-FG, O/P-FG:100M Ohms / 500VDC								
	EMI CONDUCTION & RADIATION	Compliance to EN55022 (CISPR22) class A								
OTHERS	HARMONIC CURRENT	Compliance to EN61000-3-2,3								
	EMS IMMUNITY	Compliance to EN61000-4-2,3,4,5,6,8,11, Light industry level, criteria A								
	POWER GOOD SIGNAL	Open collector of NPN transistor								
NOTE	SPECIAL FUNCTION	DC Voltage Adj., remote sensing, remote control, parallel operation(refer to control terminal instruction manual)								
	COOLING	By fan, >20% load or >50°C fan on								
	MTBF	74.9K hrs min. MIL-HDBK-217F(25°C)								
	DIMENSION	290*120*68mm (L*W*H)								
PACKING	2.3kg ; 8pcs / 20kg / CARTON									
NOTE	<ol style="list-style-type: none"> 1. All parameters NOT specially mentioned are measured at 230VAC input, rated load and 25°C of ambient temperature. 2. Ripple & noise are measured at 20MHz of bandwidth by using a 12" twisted pair-wire terminated with a 0.1uf & 47uf parallel capacitor. 3. Tolerance : includes set up tolerance, line regulation and load regulation. 4. Current limiting 3 times(1.5s,3.0s,5.0s)Then intelligent auto recovery before shut down 5. The power supply is considered a component which will be installed into a final equipment. The final equipment must be re-confirmed that it still meets EMC directives. 									

Unit:mm

Mechanical Specification

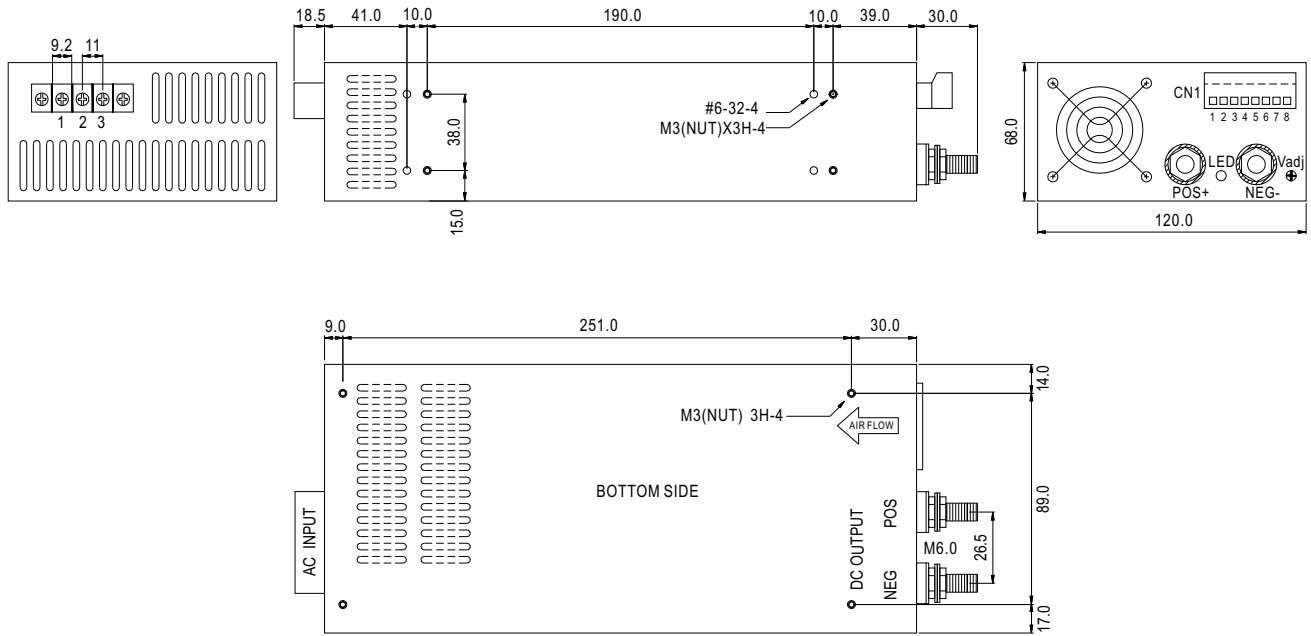

Terminal Pin. No. Assignment

Pin No.	Assignment
1	AC/L
2	AC/N
3	FG \perp

Control terminal Pin. No. Assignment (CN1) : Dinkle 51HDBC-O8P or equivalent

Pin No.	Assignment	Pin No.	Assignment	Mating With
1	VS+	5	PG	Dinkle 51SDB-O8P or equivalent
2	VS-	6	PAR	
3	VCI	7	GND	
4	VCO	8	INH	

Derating Curve

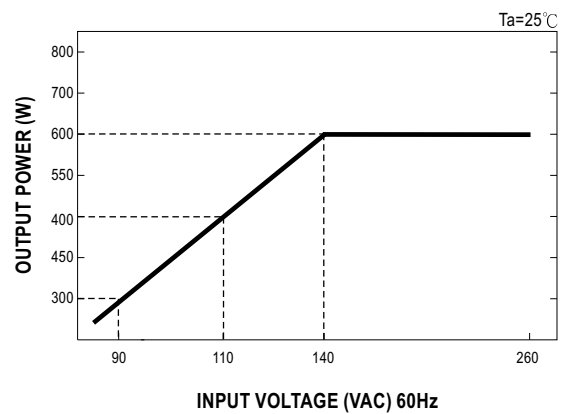
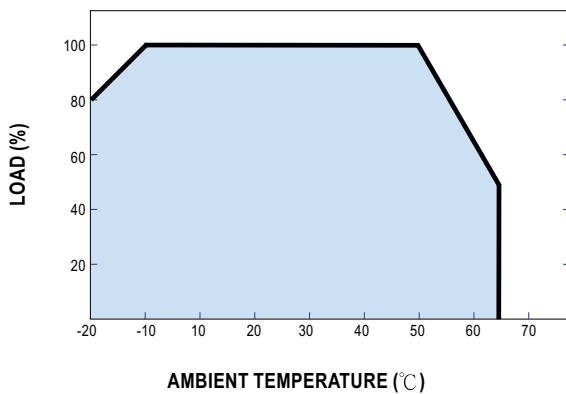

Control terminal instruction manual

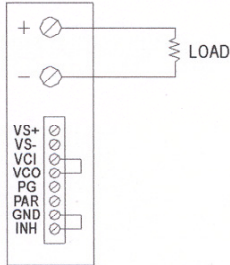

USING INTERNAL VOLTAGE CONTROL

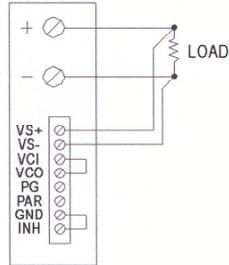

REMOTE SENSING

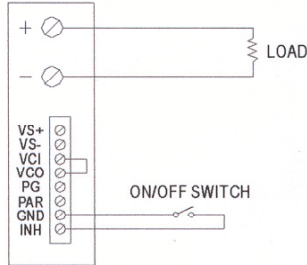

ON/OFF CONTROL BY SWITCH

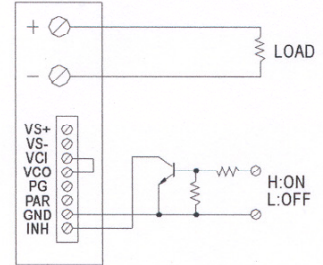

ON/OFF CONTROL BY TRANSISTOR

GOOD : LED OFF
FAIL : LED ON

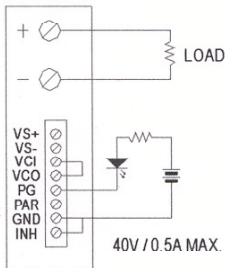

POWER GOOD SIGNAL

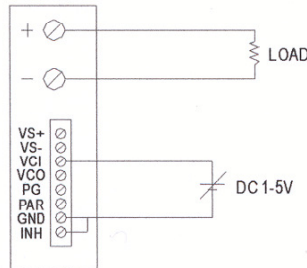

OUTPUT VOLTAGE ADJUST WITH DC 1-5V

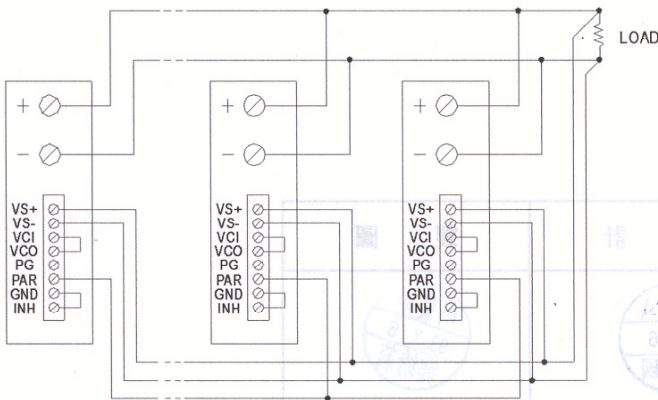
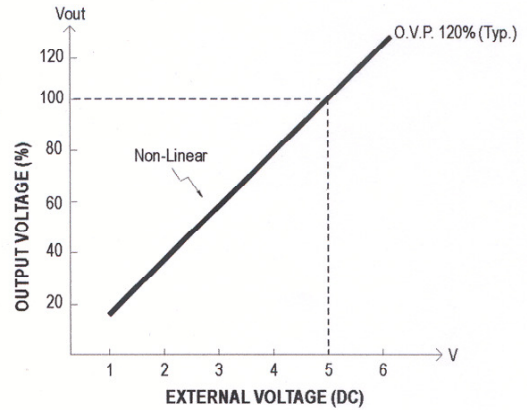

PARALLEL OPERATION WITH REMOTE SENSING

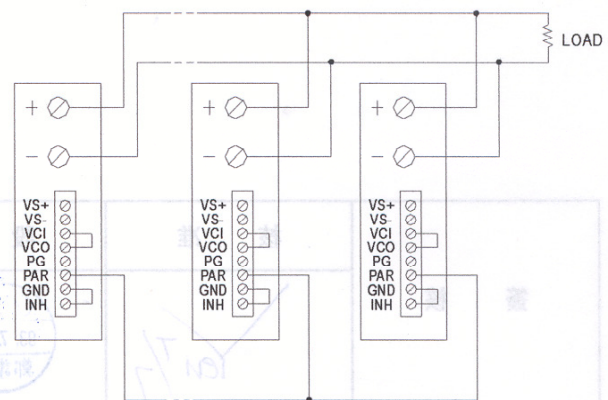

PARALLEL OPERATION WITHOUT REMOTE SENSING