

### HIGH EFFICIENCY RECTIFIER

VOLTAGE RANGE: 100 --- 200 V  
CURRENT: 1.0 A

#### FEATURES

- ◇ Low cost
- ◇ Diffused junction
- ◇ Low leakage
- ◇ Low forward voltage drop
- ◇ High current capability
- ◇ Easily cleaned with alcohol, Isopropanol and similar solvents
- ◇ The plastic material carries U/L recognition 94V-0

#### MECHANICAL DATA

- ◇ Case: JEDEC DO--41, molded plastic
- ◇ Terminals: Axial lead ,solderable per MIL- STD-202, Method 208
- ◇ Polarity: Color band denotes cathode
- ◇ Weight: 0.012 ounces, 0.34 grams
- ◇ Mounting position: Any

#### DO - 41

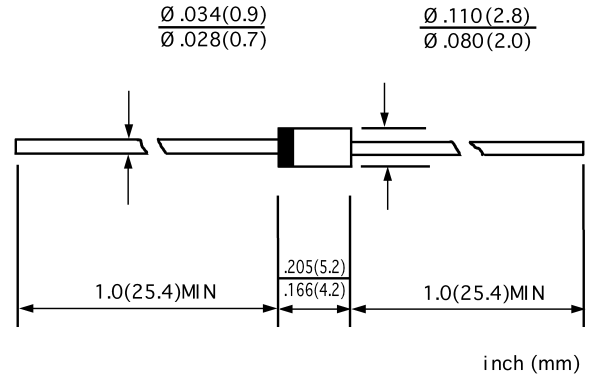

#### MAXIMUM RATINGS AND ELECTRICAL CHARACTERISTICS

Ratings at 25°C ambient temperature unless otherwise specified.

Single phase, half wave, 60 Hz, resistive or inductive load. For capacitive load, derate by 20%.

		ERA32 - 01	ERA32 - 02	UNITS
Maximum recurrent peak reverse voltage	$V_{RRM}$	100	200	V
Maximum RMS voltage	$V_{RMS}$	70	140	V
Maximum DC blocking voltage	$V_{DC}$	100	200	V
Maximum average forward rectified current 9.5mm lead length, @ $T_A=75^\circ C$	$I_{F(AV)}$	1.0		A
Peak forward surge current 8.3ms single half-sine-wave superimposed on rated load @ $T_J=125^\circ C$	$I_{FSM}$	40.0		A
Maximum instantaneous forward voltage @ 1.0A	$V_F$	0.92		V
Maximum reverse current @ $T_A=25^\circ C$ at rated DC blocking voltage @ $T_A=100^\circ C$	$I_R$	5.0	50.0	$\mu A$
Maximum reverse recovery time (Note1)	$t_{rr}$	50		ns
Typical junction capacitance (Note2)	$C_J$	20		pF
Typical thermal resistance (Note3)	$R_{\theta JA}$	60		$^\circ C/W$
Operating junction temperature range	$T_J$	- 55 ----- + 150		$^\circ C$
Storage temperature range	$T_{STG}$	- 55 ----- + 150		$^\circ C$

NOTE: 1. Measured with  $I_F=0.5A$ ,  $I_R=1A$ ,  $I_{rr}=0.25A$ .

2. Measured at 1.0MHz and applied reverse voltage of 4.0V DC.

3. Thermal resistance from junction to ambient.

www.galaxycn.com

**FIG.1--TEST CIRCUIT DIAGRAM AND REVERSE RECOVERY TIME CHARACTERISTIC**

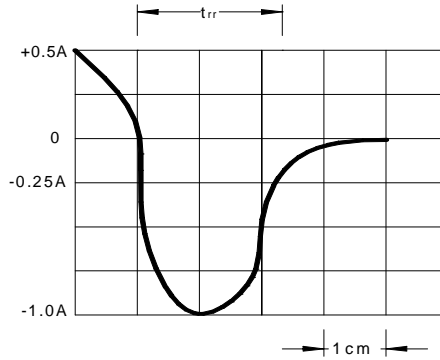
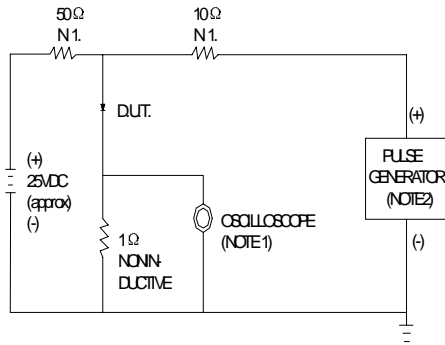

**FIG.3 --FORWARD DERATING CURVE**

AVERAGE FORWARD RECTIFIED CURRENT. AMPERES

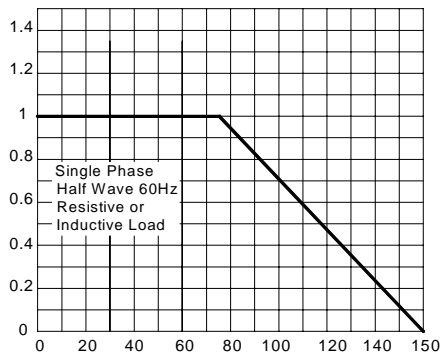

AMBIENT TEMPERATURE. °C

**FIG.4--TYPICAL JUNCTION CAPACITANCE**

JUNCTION CAPACITANCE,pF

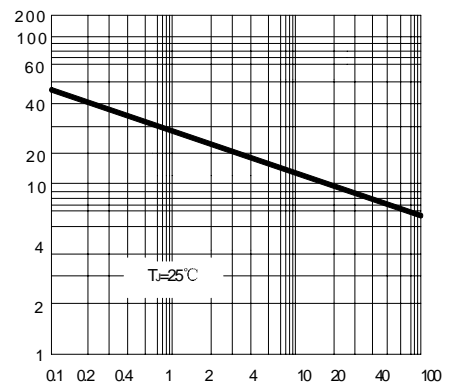

REVERSE VOLTAGE,VOLTS

**FIG.5--PEAK FORWARD SURGE CURRENT**

PEAK FORWARD SURGE CURRENT. AMPERES

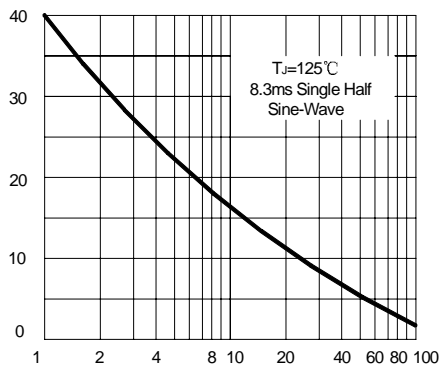

NUMBER OF CYCLES AT 60Hz

**FIG.1 -- TYPICAL FORWARD CHARACTERISTIC**

INSTANTANEOUS FORWARD CURRENT AMPERES

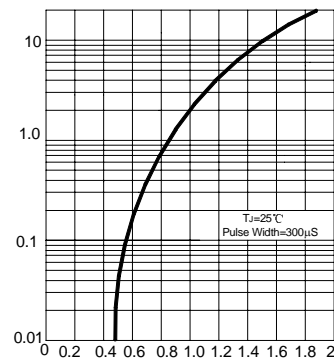

INSTANTANEOUS FORWARD VOLTAGE, VOLTS