

NEW

IMAGE SENSOR

Flat panel sensor C7921CA-09

High resolution and high frame rate

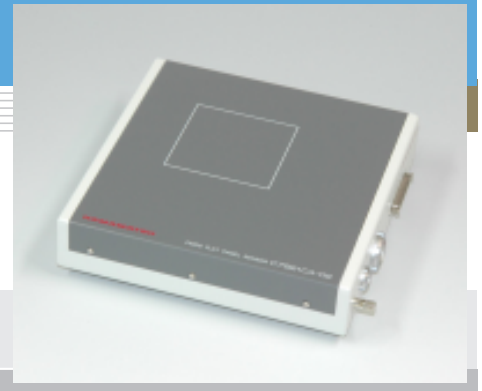

Flat panel sensor C7921CA-09 is a digital X-ray image sensor newly developed as key devices for non-destructive inspection, biochemical imaging, X-ray microscopy and other real-time X-ray imaging applications requiring high resolution and high image quality.

Features

- High quality image: 1056 × 1056 pixels
- Pixel size: 50 × 50 μm
- Flat panel structure without image distortion
- Digital output (12 bits)
- High-speed imaging:
 - 4 frames/s (single binning)
 - 16 frames/s (4 × 4 binning)
- Wide dynamic range
- High cost performance

Applications

- Non-destructive inspection
- Digital X-ray photography

■ Block diagram

C7921CA-09 is a lightweight and compact flat panel sensor consisting of a sensor board and a control board. The sensor board also has 8 charge-sensitive amplifier arrays each having 132 ch amplifiers with a horizontal shift register. Analog video signals are amplified as the charge on each video line by 1056 ch charge amplifiers with CDS (Correlated Double Sampling) circuits added, and are output each of 8 amplifier arrays. The control board converts the analog video signal into a 12-bit digital signal and outputs it to an external frame grabber through the 12-bit parallel port.

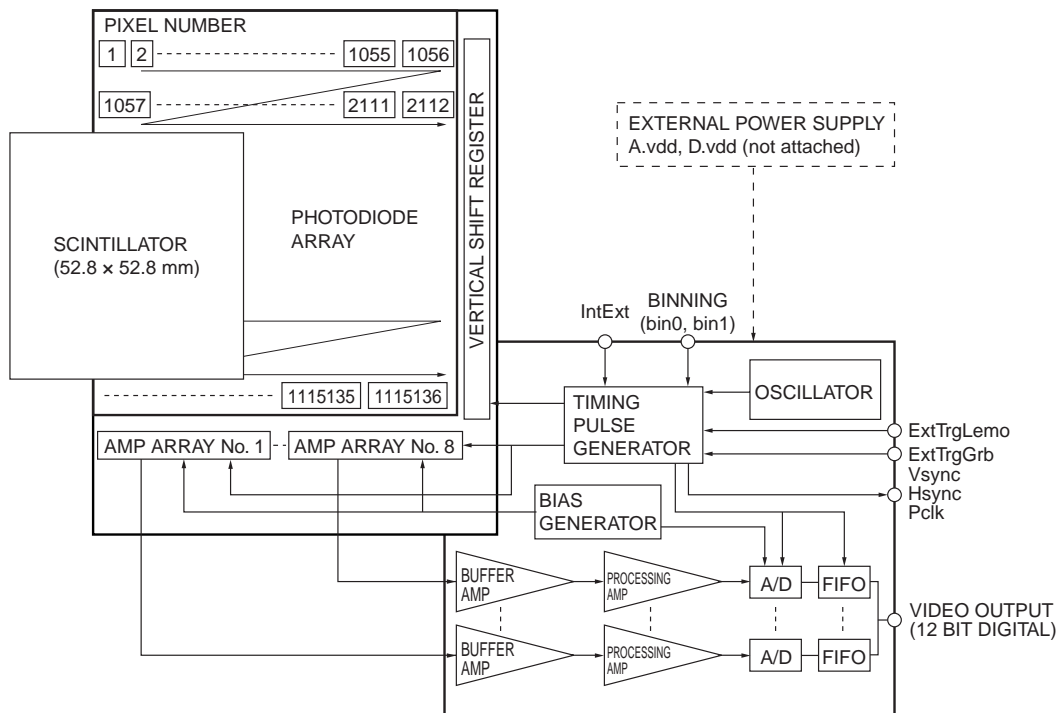

KACCC0358EA

Note: Signals are read out in order of pixel number.

PRELIMINARY DATA
Jan. 2007

SOLID STATE DIVISION

HAMAMATSU

■ General ratings

Parameter	Specification	Unit
Pixel size	50 × 50	μm
Photodiode area	52.8 × 52.8	mm
Number of pixels	1056 × 1056	pixels
Number of active pixels	1032 × 1012	pixels
Readout	Charge amplifier array	-
Video output (Data1 - 12)	RS-422 (differential) 12 bit	-
Output data rate	6.25	MHz
Synchronous signal (Vsync, Hsync, Pclk)	RS-422 (differential)	-
bin0/1, ExtTrgGrb, ExtTrgLemo, IntExt	TTL	-
Scintillator	CsI	-

■ Absolute maximum ratings (Ta=25 °C)

Parameter	Symbol	Value	Unit
Supply voltage for digital circuitry (+5 V)	D.vdd	+6.0	V
Supply voltage for analog circuitry (+5 V)	A.vdd	+6.0	V
Input voltage (bin0/1, ExtTrgGrb, ExtTrgLemo, IntExt)	Vin	0 to 6.0	V
Operating temperature *1	Topr	0 to +35	°C
Storage temperature *1	Tstg	0 to +50	°C

*1: No condensation

■ Specification (Ta=25 °C, A.vdd= 5.0 V, D.vdd= 5.0 V)

Parameter	Symbol	Min.	Typ.	Max.	Unit
Frame rate (single operation)	Sf (int)	3.8	4	-	frames/s
Frame rate (2 × 2 binning)	-	-	8	-	frames/s
Frame rate (4 × 4 binning)	-	-	16	-	frames/s
Frame rate external (single operation)	Sf (ext)	-	Sf (int) to 0.1	-	frames/s
Noise (rms) *2	N (rms)	-	1000	-	electrons
Sensitivity *3	S	14.4	18	-	LSB/mR
Saturation charge	Csat	-	2.9	-	M electrons
Resolution *4	Reso	7.1	8	-	line pairs/mm
Dynamic range	-	-	2900	-	-
Defect line *5	-	-	-	10	lines
Output offset *6	-	-	65	200	LSB

*2: Internal trigger mode, single operation

*3: At 80 kVp without filter

*4: Spatial frequency at CTF=5 %

*5: A defect line is a horizontal or vertical line containing 4 or more pixels that produce less than 1/8 of the average output from surrounding pixels and are formed continuously from the opposite side of an amplifier array or a vertical shift register. Without a couple of adjacent defect line.

*6: Average of all effective pixels in single operation at Sf (int)

Note: X-ray energy range is 20 k to 100 kVp.

■ Resolution

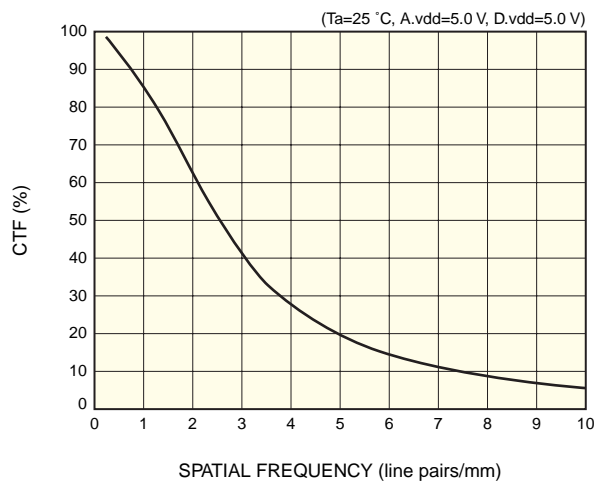

KACCB0156EA

■ Timing chart

To acquire images through an image grabber board, write parameters in the software program or parameter file by referring to the following timing chart and description.

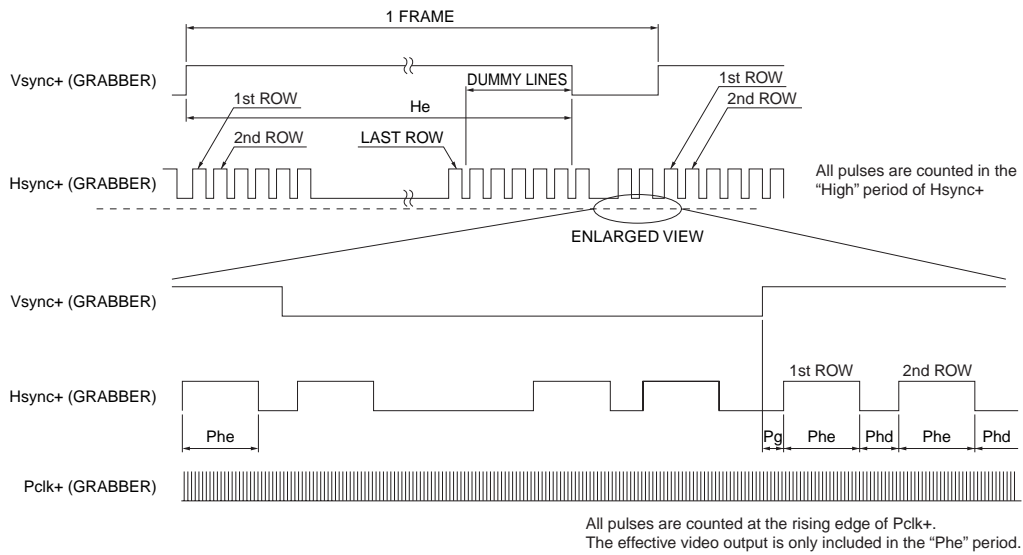

KACCC0362EA

Parameter		Pulse		
		1 × 1	2 × 2	4 × 4
He	Effective line	1012	506	253
	Dummy line	44	22	11
Phe	Effective pixel	1032	516	258
	Dummy pixel	25	13	7
Phd		366	894	1158
Pg		17	17	17

Note: "He" is the Hsync count. Phe, Phd and Pg are the Pclk count.

■ External trigger mode

To acquire images in external trigger mode, input an external trigger pulse as shown below. When the time Tvd has passed after the rising edge of the external trigger pulse, synchronous signals and video signals are output.

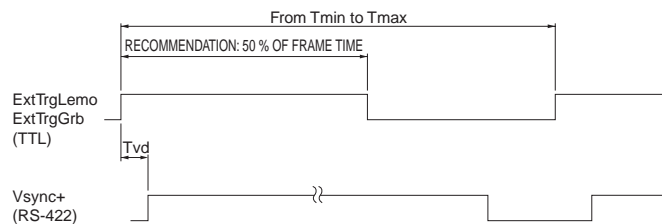

- Hsync+, Pclk+ and Data 1-12 are the same as internal trigger mode.
- Tmin is defined as 1/Sf (int).
 - Tmax is defined as the reciprocal of the minimum value of Sf (ext).
 - Tvd=450 μs

KACCC0363EA

■ System requirements

To operate C7921CA-09 at full performance, the following system and peripherals are required.

- PC: IBM compatible PC running on Windows XP
- Digital frame grabber card: Monochrome 16 bits or more, pixel clock 7 MHz or more, RS-422 interface synchronous signal (See the frame grabber manual.)

The National Instruments IMAQ PCI-1424 (NI parts No. 777662-01) frame grabber has been verified to successfully acquire 12-bit digital images from C7921CA-09. The IMAQ PCI-1422 (NI parts No. 777959-01) also acquires satisfactory images from C7921CA-09. You can utilize the demonstration software that comes with the frame grabber as a simple viewer, to acquire and save an image. To do so, refer to the frame grabber user's guide for how to use the camera information file for the demonstration software.

- Power source: A.vdd = +5.0 ± 0.1 V (700 mA), D.vdd = +5.0 ± 0.1 V (800 mA).

Please use of a series power supply. (Avoid using a switching power supply.) A power cable (terminated with an FGG.2B.307.CLAD92Z plug at one end and open at the other end; 2 m; see Table 2.), an external trigger cable (terminated with an FFA.OS.302.CLAC37 plug at one end and open at the other end; 5 m; see table 3.) and an earth cable (AWG 18; 4 m) comes supplied with C7921CA-09. An optional frame grabber cable for interface with the 36-pin receptacle (see Table 1) on C7921CA-09 is also available for synchronous signal, video output and external control.

The voltages described above are specified at the flat panel sensor side. The impedance of the power cable attached with the flat panel sensor is low enough but it causes 0.1 V approx. drop. Therefore the voltage at the power source side should be set 0.1 V higher than the voltage specified above.

Install a noise filter on the AC power input line to prevent surges on the AC line.

To supply the synchronous signal through ExtTrgGrb, apply high level of TTL to ExtTrgLemo and IntExt, or leave them without connection. On the contrary, to use ExtTrgLemo, set high level to ExtTrgGrb and IntExt, or leave them without connection. The earth terminal must be connected to a stable earth point to eliminate noise from surroundings.

Table 1: Pin assignment of 36-pin receptacle

Pin No.	Signal	Pin No.	Signal
1	Data12+ (MSB)	19	Data12- (MSB)
2	Data11+	20	Data11-
3	Data10+	21	Data10-
4	Data9+	22	Data9-
5	Data8+	23	Data8-
6	Data7+	24	Data7-
7	Data6+	25	Data6-
8	Data5+	26	Data5-
9	Data4+	27	Data4-
10	Data3+	28	Data3-
11	Data2+	29	Data2-
12	Data1+(LSB)	30	Data1- (LSB)
13	bin0 (TTL)	31	GND
14	bin1 (TTL)	32	GND
15	ExtTrgGrb (TTL)	33	IntExt (TTL)
16	Vsync+	34	Vsync-
17	Hsync+	35	Hsync-
18	Pclk+	36	Pclk-

Unless otherwise noted, signal level is RS-422.

36-pin receptacle: TX20A-36R-D2GF1-A1L made by JAE (Japan Aviation Electronics Industry limited)

Mating plug: TX20A-36PH1-D2P1-D1E made by JAE (Japan Aviation Electronics Industry limited)

Table 2: Power pin assignment and cable color

Pin No.	Color	Signal
1	Brown	Reserved
2	Red	Reserved
3	Orange	Reserved
4	Yellow	Analog GND
5	Green	Analog +5 V
6	Blue	Digital GND
7	Purple	Digital +5 V
Shield	-	Analog GND

7-pin power receptacle: ECG.2B.307.CLV made by LEMO S. A.

Mating power plug: FGG.2B.307.CLAD92Z made by LEMO S. A.

Pin No. 1 to 3 are not connected to the electrical circuit inside of flat panel sensor.

Therefore, previous power source and cable for C7921CA-02 can be used without modification.

Table 3: External trigger pin assignment and cable color

Pin No.	Color	Signal
1	Red	ExtTrgLemo (TTL)
2	Black	Signal GND
Shield	-	Analog GND

2-pin receptacle: ECP.OS.302.CLL made by LEMO S. A.

Mating plug: FFA.OS.302.CLAC37 made by LEMO S. A.

■ Connection

Install the frame grabber board into the PC by the manufacturer's instructions. When a general-purpose frame grabber board is used, binning or trigger operation for bin0, bin1, IntExt and ExtTrgGrb can be controlled with its digital I/O control.

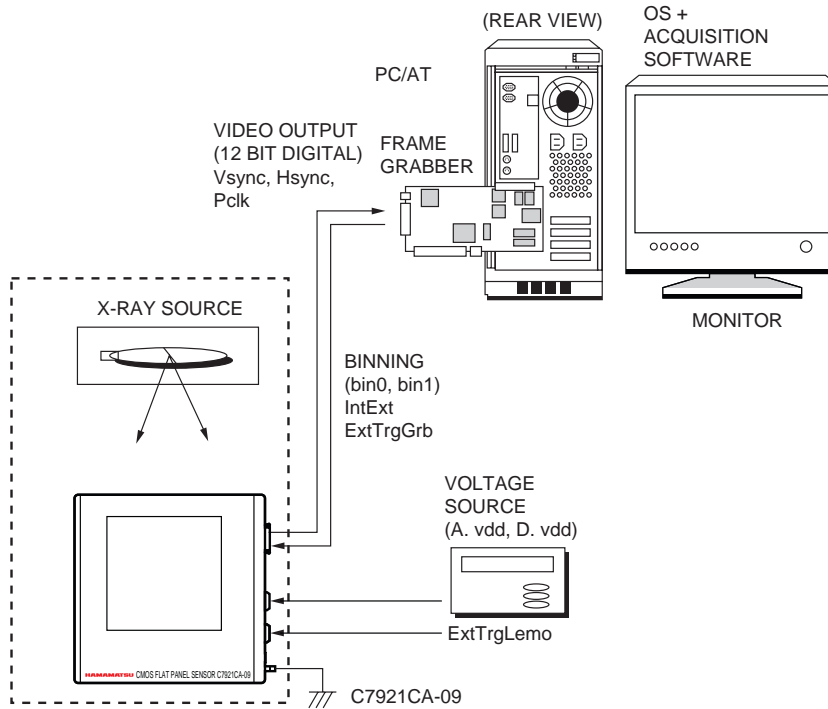

KACCC0354EA

■ Dimensional outline (unit: mm, tolerance: ±1 mm unless otherwise noted)

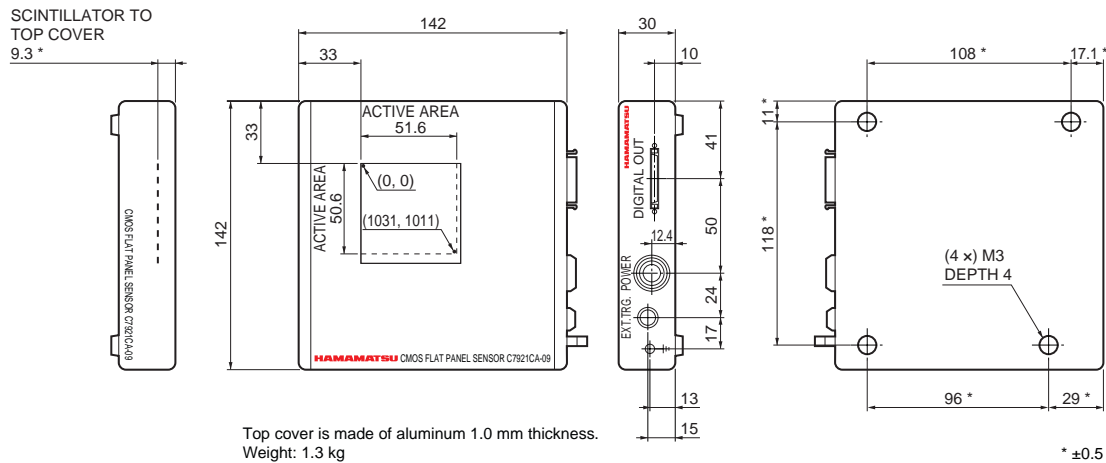

KACCA0201EA

■ Notice

- Do not subject the Flat Panel Sensors to strong vibration or shock. (Strong shock such as drop impacts may cause permanent damage to these sensors.)
- Users must take responsibility for implementing X-ray shielding safety measures to avoid the risk of X-ray exposure.
- Data listed in this datasheet is defined at the time of shipment. Characteristics may vary somewhat due to exposure to X-rays so take proper countermeasures such as making periodic image correction.
- This product is warranted for a period of 12 months after the date of the shipment.
The warranty is limited to make a replacement or repair of any defective product due to defects in workmanship or materials used in manufacture. It does not cover loss or damage caused by natural disaster, misuse (including modifications and any use not complying with the environment, application, usage and storage conditions described in this datasheet), or total radiation dose over 1 million Roentgen (less than 100 kVp) even within the warranty period.
- As described above, flat panel sensors have limited resistance to radiation. This must be taken into account when using a flat panel sensor under continuous irradiation (in-line non-destructive inspection, etc.)
When using flat panel sensors in non-destructive inspection equipment, please contact us and provide information such as irradiation conditions.

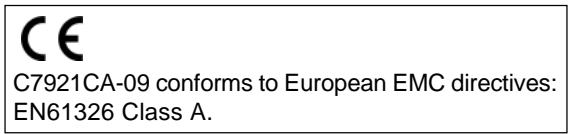

■ Optional frame grabber cables

Frame grabber	Cable type No.	Cable length	Cable end	Cable end
General-purpose	A8406-31	5 m	TX20A-36PH1-D2P1-D1E *8	open
	A8406-36	7 m		
	A8406-37	10 m		
	A8406-38	12 m		
IMAQ PCI-1424 *7	A8406-32	5 m		PCS-XE100MA+ *9
	A8406-33	7 m		
	A8406-34	10 m		
	A8406-35	12 m		

*7: Made by NI (National Instrument Corporation)

*8: Made by JAE (Japan Aviation Electronics Industry, Limited)

*9: Made by Honda Tsushin Kogyo Co. Ltd.

Note: The detailed information for these optional cables is shown in the datasheet of A8406 series.