

Preliminary Data Sheet

Features

- For UMTS Band applications
- Usable bandwidth of 60 MHz
- Low loss
- High attenuation
- No impedance matching required for operation at 50 Ω
- Single-ended operation
- Ceramic Surface Mount Package (SMP)
- Hermetic
- RoHS compliant (2002/95/EC), Pb-free 

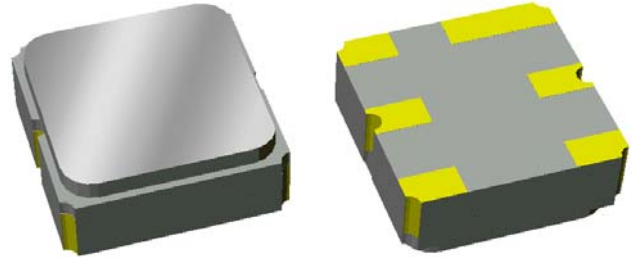

Package

Surface Mount 3.00 x 3.00 x 1.22 mm
SMP-12

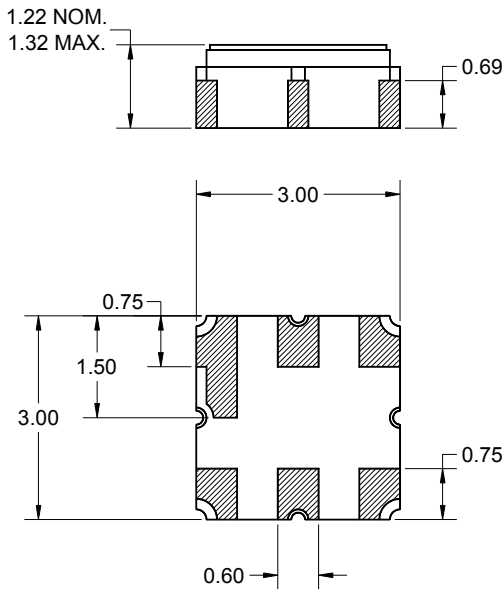

Dimensions shown are nominal in millimeters
All tolerances are ± 0.15 mm except overall length and width ± 0.10 mm

Body: Al_2O_3 ceramic
Lid: Kovar, Ni plated
Terminations: Au plating 0.5 - 1.0 μ m,
over a 2 - 6 μ m Ni plating

Pin Configuration

Bottom View

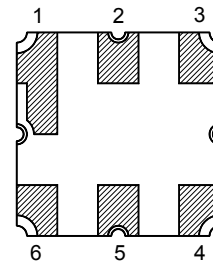

Pin No.	Description
2	Input
5	Output
1,3,4,6	Case ground

Preliminary Data Sheet

Electrical Specifications ⁽¹⁾

Operating Temperature Range: ⁽²⁾ -30 to +85 °C

Parameter ⁽³⁾	Minimum	Typical	Maximum	Unit
Center Frequency	-	1950	-	MHz
Maximum Insertion Loss 1920 - 1980 MHz	-	2.2	3.0	dB
Amplitude Ripple ⁽⁴⁾ 1920 - 1980 MHz	-	1.0	1.5	dB p-p
Absolute Attenuation 10 - 1000 MHz	25	32	-	dB
1000 - 1880 MHz	20	30	-	dB
2110 - 2170 MHz	40	45	-	dB
2170 - 3800 MHz	25	28	-	dB
3800 - 5000 MHz	18	20	-	dB
Input/Output Return Loss 1920 - 1980 MHz	8	9.8	-	dB
RF Power (10,000 hours @ 55 °C CW)	-	-	10	dBm
Source Impedance ⁽⁵⁾	-	50	-	Ω
Load Impedance ⁽⁵⁾	-	50	-	Ω

Notes:

1. All specifications are based on TriQuint test circuit shown below
2. In production, devices will be tested at room temperature to a guardbanded specification to ensure electrical compliance over temperature
3. Electrical margin has been built into the design to account for the variations due to temperature drift and manufacturing tolerances
4. Evaluated as peak-to-adjacent valley ripple
5. This is the optimum impedance in order to achieve the performance shown

Test Circuit:

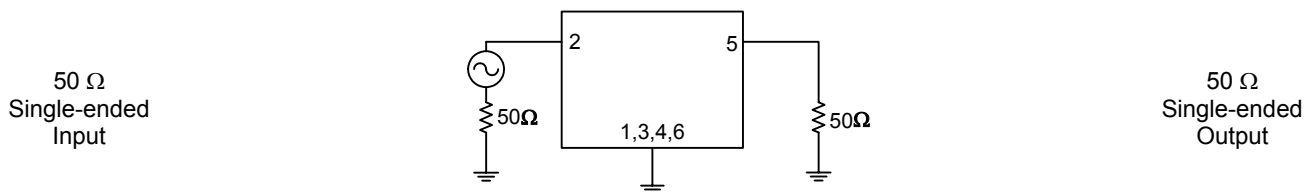

Preliminary Data Sheet

Typical Performance (at +25°C)

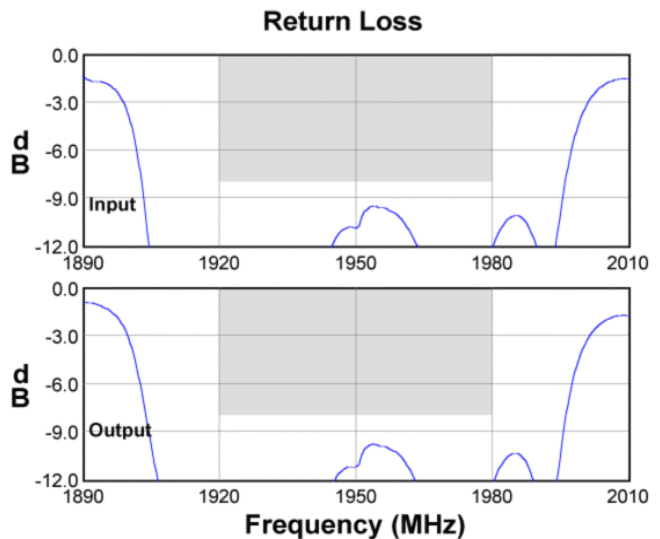
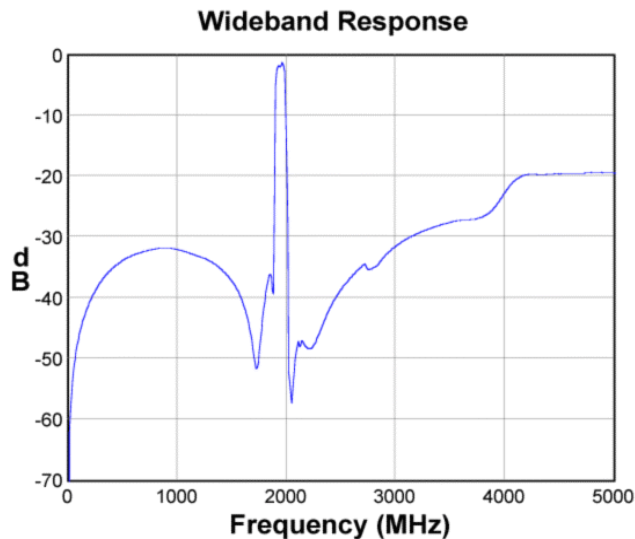
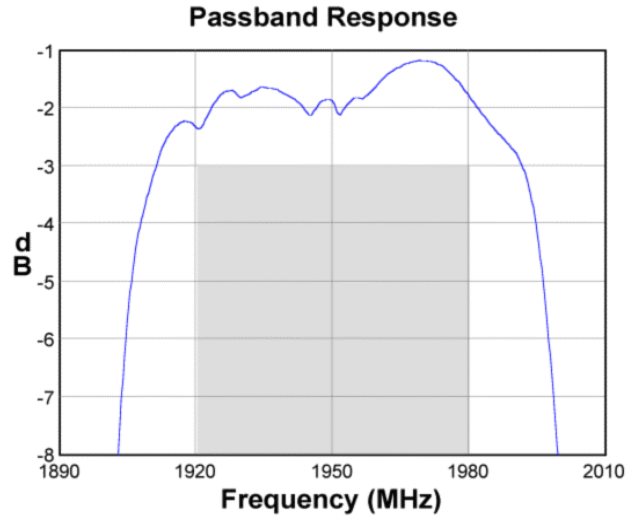
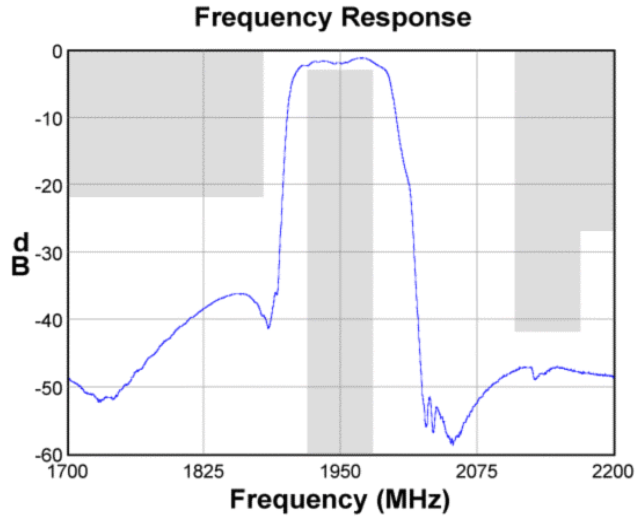

Input Smith Chart

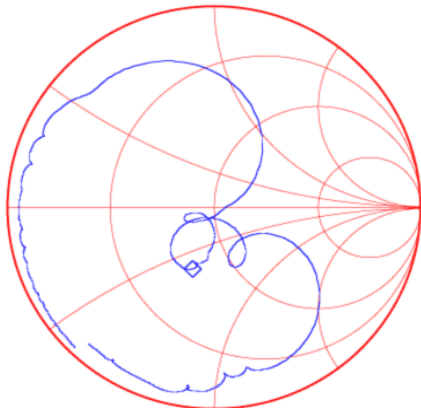

Output Smith Chart

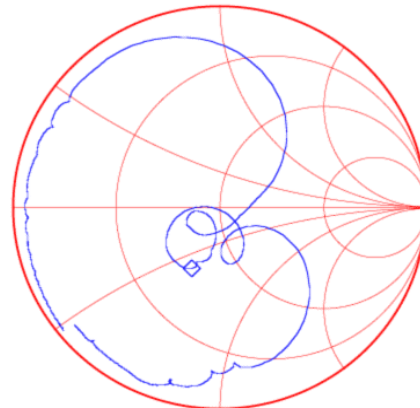

Preliminary Data Sheet

Matching Schematics

50 Ω
Single-ended
Input

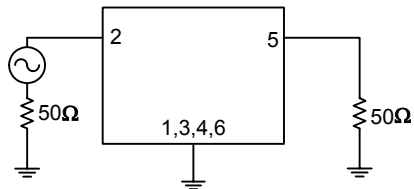

50 Ω
Single-ended
Output

Marking

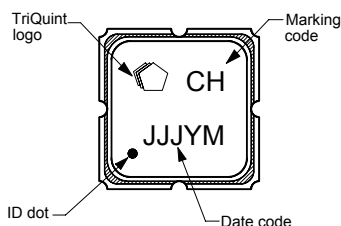

The date code consists of: JJJ = Julian day,
Y = last digit of year, M = manufacturing site code

PCB Footprint

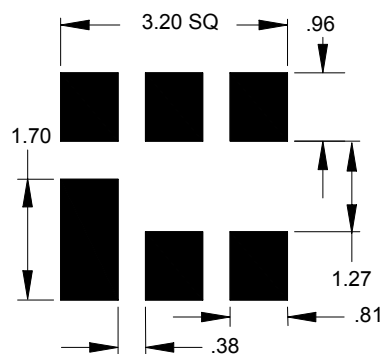

This footprint represents a recommendation only
Dimensions shown are nominal in millimeters

Tape and Reel

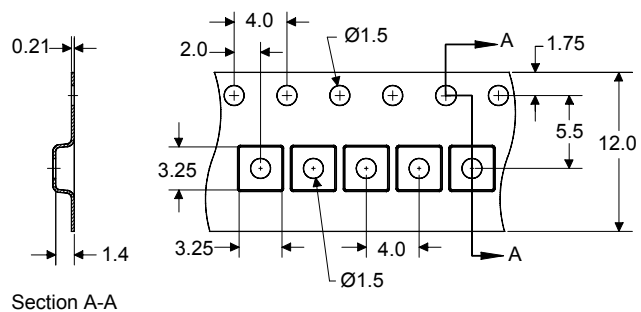
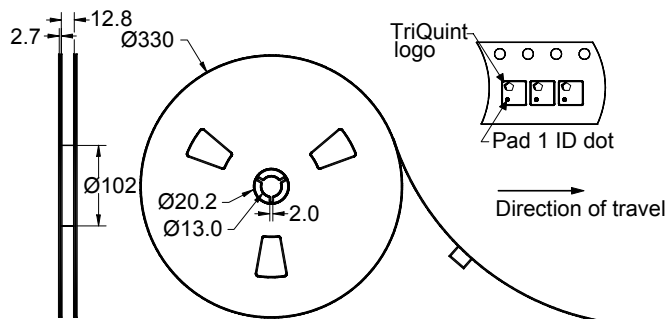

Dimensions shown are nominal in millimeters
Packaging quantity: 5000 units/reel

Preliminary Data Sheet

Maximum Ratings

Parameter	Symbol	Minimum	Maximum	Unit
Operating Temperature Range	T	-30	+85	°C
Storage Temperature Range	T _{stg}	-40	+85	°C

Important Notes

Warnings

- Electrostatic Sensitive Device (ESD) 
- Avoid ultrasonic exposure

RoHS Compliance

- This product complies with EU directive 2002/95/EC (RoHS) 

Solderability

- Compatible with JEDEC J-STD-020C **Pb-free** process, **260°C** peak reflow temperature ([see soldering profile](#))

Links to Additional Technical Information

[PCB Layout Tips](#)

[Qualification Flowchart](#)

[Soldering Profile](#)

[S-Parameters](#)

[RoHS Information](#)

[Other Technical Information](#)

TriQuint's liability is limited only to the Surface Acoustic Wave (SAW) component(s) described in this data sheet. TriQuint does not accept any liability for applications, processes, circuits or assemblies, which are implemented using any TriQuint component described in this data sheet.

Contact Information

TriQuint 
SEMICONDUCTOR

PO Box 609501
Orlando, FL 32860-9501
USA

Phone: +1 (407) 886-8860
Fax: +1 (407) 886-7061
Email: info-product@tqs.com
Web: www.triquint.com

Or contact one of our worldwide
Network of [sales offices](#),
[Representatives or distributors](#)