

### FEATURES

- Trimmed 0.5% Tolerance
- Wide Operating Current Range 60 $\mu$ A to 100mA
- Low Reference Input Current 0.4 $\mu$ A
- Low Dynamic Output Impedance
- Low Output Noise
- Nominal Temperature Range to 85°C
- Temperature-Compensated: 60ppm/°C

### APPLICATIONS

- Battery Powered Systems
- Switching Power Supplies
- Adjustable Power Supplies
- Telecommunications
- Error Amplifiers
- Notebook/Personal Computer
- Monitors/ VCR/ TV
- Pagers

### GENERAL DESCRIPTION

The AMS431L is a three-terminal adjustable shunt regulator with guaranteed temperature stability over the entire range of operation. The output voltage can be set to any value between 1.24V ( $V_{REF}$ ) and 20V by adding two external resistors. The AMS431L features 0.5% initial tolerance, low dynamic output impedance and operates over a wide current range. Due to the sharp turn-on characteristics this device is an excellent replacement for zener diodes in many applications.

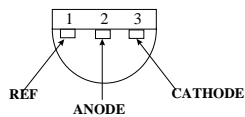
AMS431 is available in TO-92, SOT-89, 3 pin SOT-23 and 5 pin SOT-23 packages.

### ORDERING INFORMATION:

TOL.	PACKAGE TYPE				OPERATING TEMP. RANGE
	TO-92	SOT-89	3 LEAD SOT-23	5 LEAD SOT-23	
±0.5%	AMS431LAN	AMS431LAL	AMS431LAM	AMS431LAM1	-40 to +85° C
±1.0%	AMS431LBN	AMS431LBL	AMS431LBM	AMS431LBM1	-40 to +85° C
±2.0%	AMS431LCN	AMS431LCL	AMS431LCM	AMS431LCM1	-40 to +85° C

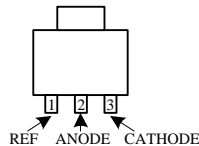
### PIN CONNECTIONS

**TO-92**  
Plastic Package (N)



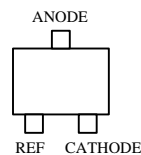
Bottom View

**SOT-89**  
(L)



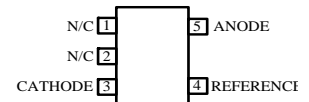
Top View

**3L SOT-23**  
(M)



Top View

**5L SOT-23**  
(M1)



Top View

## ABSOLUTE MAXIMUM RATINGS (Note 1)

Cathode Voltage ( $V_Z$ )	20V	Internal Power Dissipation ( $P_D$ )	
Continuous Cathode Current ( $I_Z$ )	100mA	TO-92 Package	0.78W
Reference Input Current ( $I_{REF}$ )	3mA	SOT-89 Package	0.91W
Junction Temperature ( $T_J$ )	-40°C to +125°C	SOT-23-3 Package	0.28W
		SOT-23-5 Package	0.3 W
Storage temperature	-65°C to +150°C	Thermal Resistance ( $\theta_{JA}$ )	
Lead Temperature (Soldering, 25sec.)	265°C	TO-92 Package	160°C/W
		SOT-89 Package	110°C/W
		SOT-23-3 Package	410°C/W
		SOT-23-5 Package	410°C/W

**Note 1 :** Absolute Maximum Ratings indicate limits beyond which damage to the device may occur. Operating Ratings indicate conditions for which the device is intended to be functional, but do not guarantee specific performance limits. For guaranteed specifications and test conditions, see the Electrical Characteristics. The guaranteed specifications apply only for the test conditions listed.

## ELECTRICAL CHARACTERISTICS

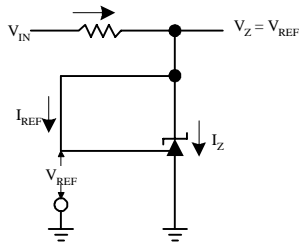
Electrical Characteristics at  $I_Z=10$  mA and  $T_A = +25^\circ\text{C}$  unless otherwise noted.

Parameter	Conditions	AMS431LA			AMS431LB			AMS431LC			Units
		Min	Typ	Max	Min	Typ	Max	Min	Typ	Max	
Reference Voltage		1.234	1.240	1.246	1.228	1.240	1.252	1.215	1.240	1.265	V
Deviation of Reference Input Voltage over Temperature	$V_Z = V_{REF}$ (circuit 1) $T_A = -40^\circ\text{C}$ to $+85^\circ\text{C}$		10	25		10	25		10	35	mV
Ratio of Change in Reference Voltage to Cathode Voltage	$I_Z = 10\text{mA}$ $\Delta V = \text{from } V_{REF}$		-0.5	-2.7		-0.5	-2.7		-0.5	-2.7	mV/V
Reference Input Current	$R1 = 10\text{k}\Omega$ , $R2 = \infty\Omega$ (test circuit 2)		0.15	0.5		0.15	0.5		0.15	0.5	$\mu\text{A}$
Reference Input Current Deviation over Temperature	$R1 = 10\text{k}\Omega$ , $R2 = \infty\Omega$ $T_A = \text{Full Range}$ (test circuit 2)		0.1	0.4		0.1	0.4		0.1	0.4	$\mu\text{A}$
Off State Cathode Current	$V_Z = 6\text{V}$ , $V_{REF} = 0\text{V}$ ( test circuit 3)		0.04	0.1		0.04	0.1		0.04	0.1	$\mu\text{A}$
Dynamic Output Impedance	$f < 1\text{KHz}$ , $V_Z = V_{REF}$ $I_Z = 100\mu\text{A}$ to $100\text{mA}$ (test circuit 1)		0.25	0.4		0.25	0.4		0.25	0.4	$\Omega$
Minimum Operating Current	$V_Z = V_{REF}$ (test circuit 1)		60	80		60	80		60	80	$\mu\text{A}$

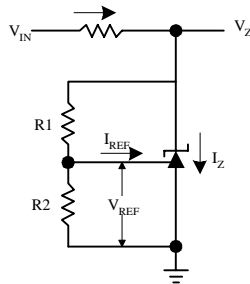
## RECOMMENDED OPERATING CONDITIONS:

	Min	Max
Cathode Voltage, ( $V_Z$ )	$V_{REF}$	20 V
Cathode Current, ( $I_Z$ )	80 $\mu\text{A}$	100mA

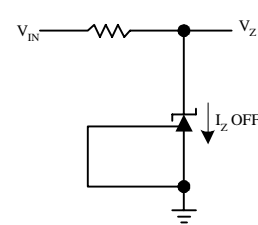
## TEST CIRCUITS



**Figure 1.** Test Circuit for  $V_Z = V_{REF}$

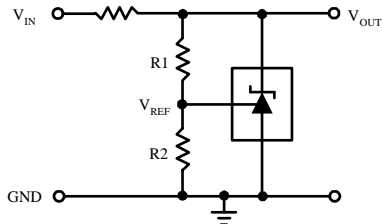


**Figure 2.** Test Circuit for  $V_{REF}$  vs  $I_Z$ .  
Test circuit for  $I_{REF}$ .



**Figure 3.** Test Circuit for Off-State Current

## TYPICAL APPLICATIONS



1) Set the  $V_{OUT}$  according to the following equation:

$$V_{OUT} = V_{REF} \left( 1 + \frac{R1}{R2} \right) + I_{REF} R1$$

2) Choose the value of R as follows:

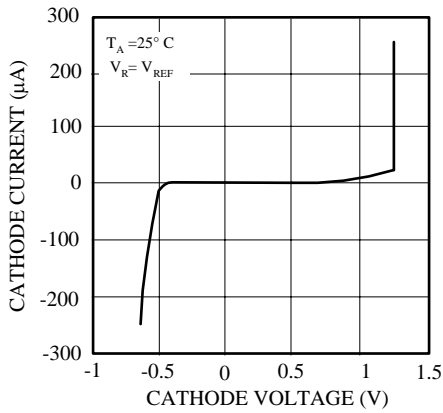
- The maximum limit for R should be such that the cathode current,  $I_Z$  is greater than the minimum operating current ( $80\mu A$ ) at  $V_{IN(min)}$ .
- The minimum limit for R should be such that  $I_Z$  does not exceed 100mA under all load conditions, and the instantaneous turn-on value for  $I_Z$  does not exceed 150mA. Both of the following conditions must be met:

$$R_{min} \geq \frac{V_{IN(max)}}{150mA} \text{ (to limit instantaneous turn - on } I_Z)$$

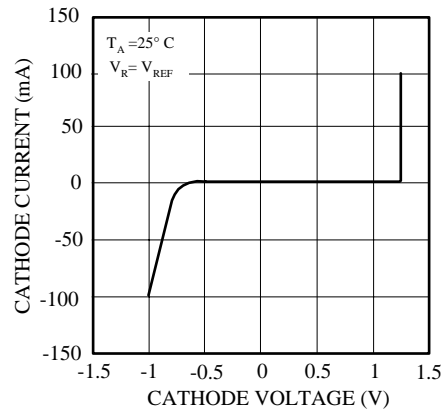
$$R_{min} \geq \frac{V_{IN(max)} - V_{OUT}}{I_{OUT(min)} + 100mA} \text{ (to limit } I_Z \text{ under normal operating conditions)}$$

## TYPICAL PERFORMANCE CHARACTERISTICS

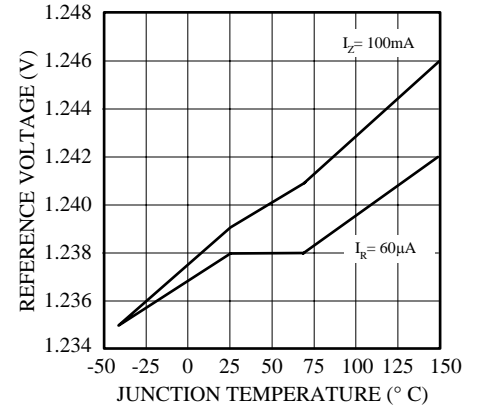
**Cathode Current vs. Cathode Voltage**



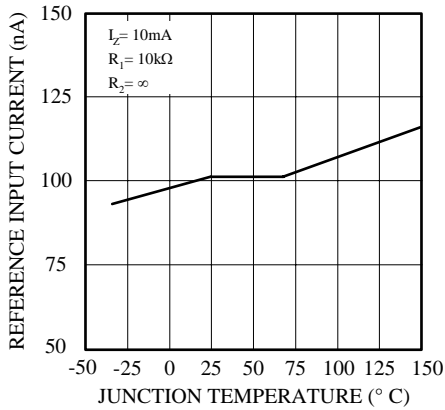
**Cathode Current vs. Cathode Voltage**



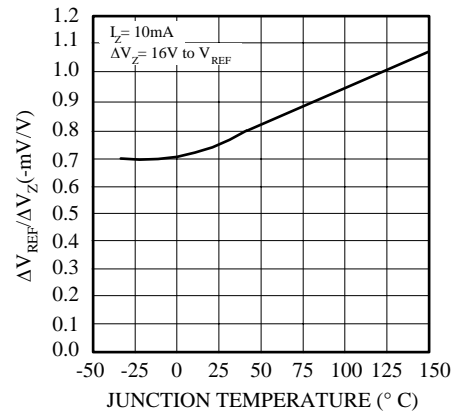
**Reference Voltage vs. Junction Temperature**



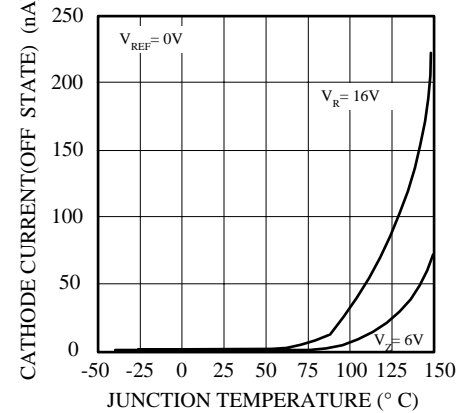
**Reference Input Current vs. Junction Temperature**



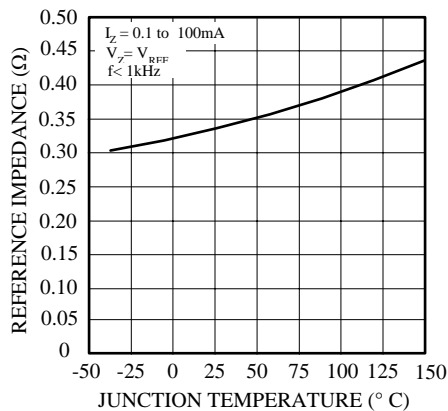
**Ratio of Delta Reference Voltage to Delta Cathode Voltage vs. Junction Temperature**



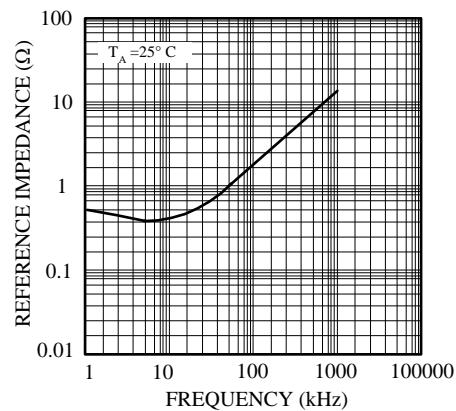
**Off State Cathode Current vs. Junction Temperature**



**Reference Impedance vs. Junction Temperature**

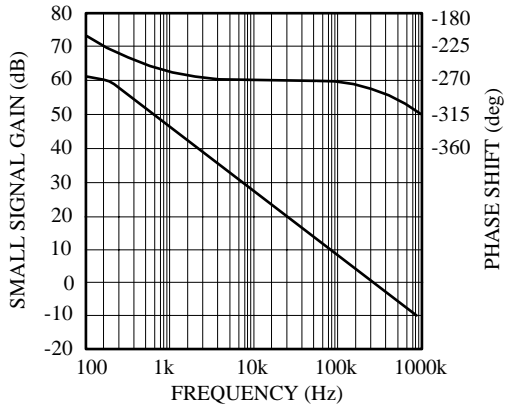


**Reference Impedance vs. Frequency**

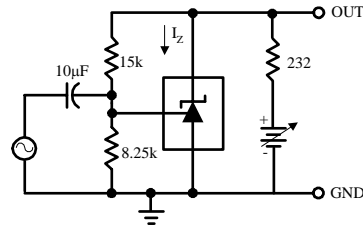


## TYPICAL PERFORMANCE CHARACTERISTICS (Continued)

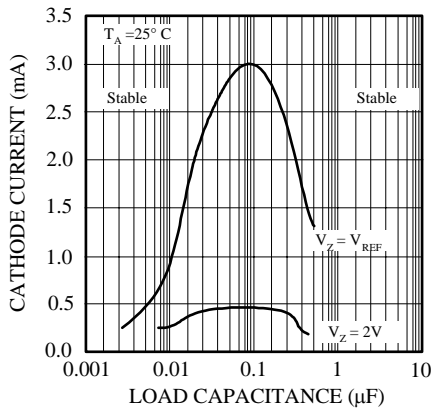
**Small Signal Gain and Phase Shift vs. Frequency**



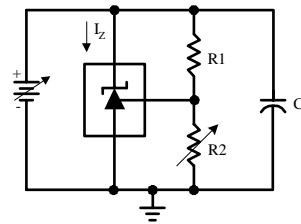
**Small Signal Gain and Phase Shift Test Circuit**



**Stability Boundary Condition**

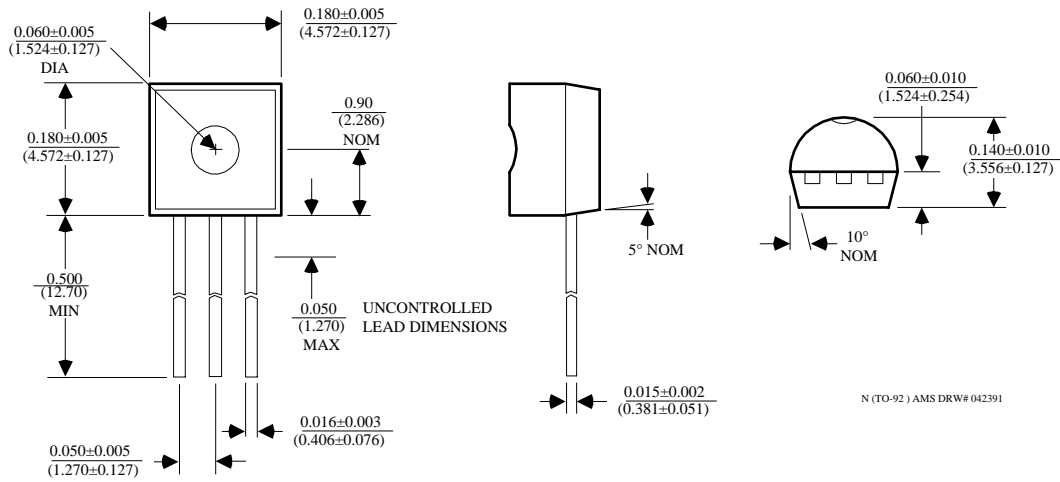


**Stability Circuit**

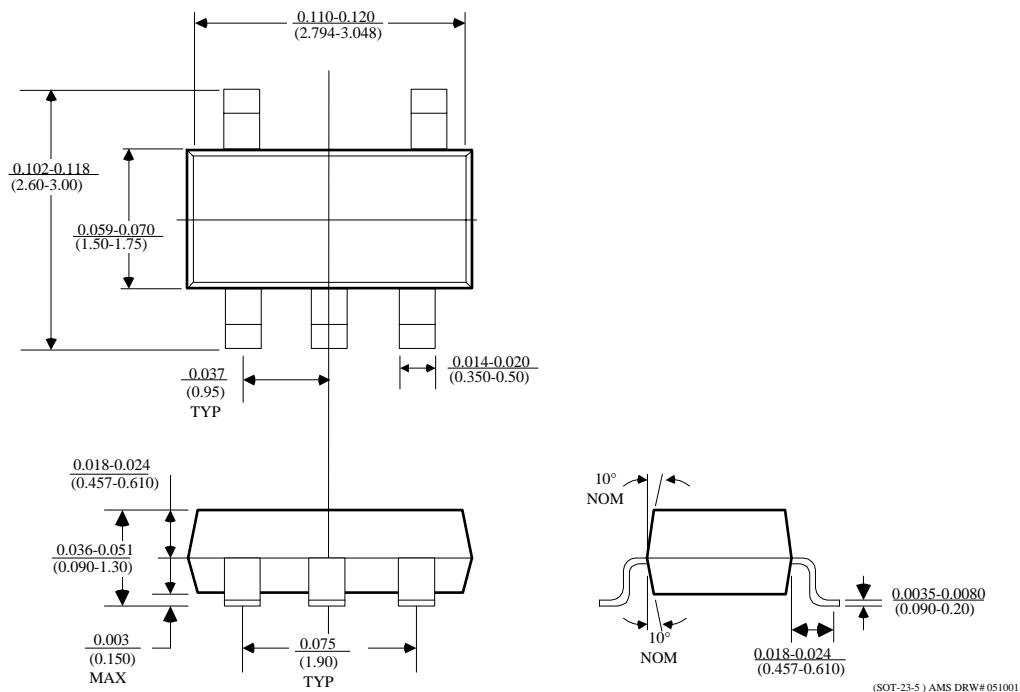


PACKAGE DIMENSIONS inches (millimeters) unless otherwise noted.

## 3L TO-92 PLASTIC PACKAGE (N)

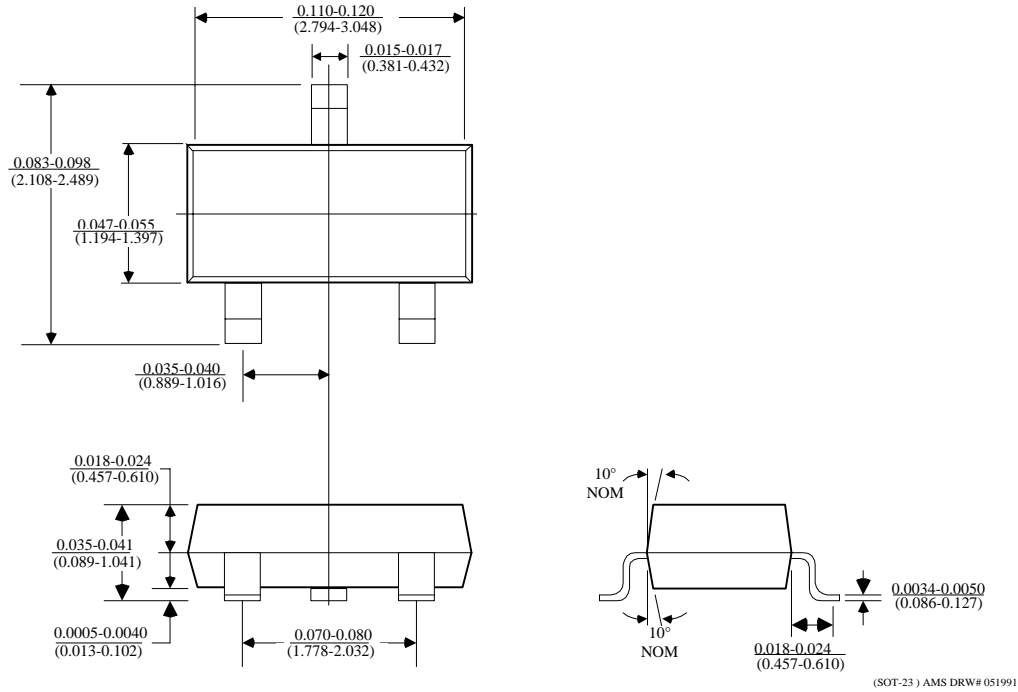


## 5 LEAD SOT-23 PLASTIC PACKAGE (M1)



PACKAGE DIMENSIONS inches (millimeters) unless otherwise noted (Continued).

## 3 LEAD SOT-23 PLASTIC PACKAGE (M)



## SOT-89 PLASTIC PACKAGE (L)

