

# S3PDB50

## Three Phase Rectifier Modules

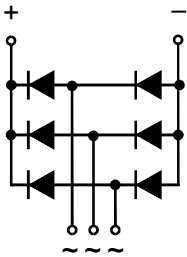
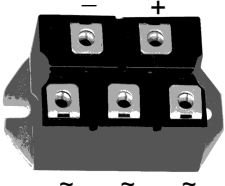

Type	$V_{RSM}$ V	$V_{RRM}$ V
S3PDB50N08	900	800
S3PDB50N12	1300	1200
S3PDB50N14	1500	1400
S3PDB50N16	1700	1600
S3PDB50N18	1900	1800

Dimensions in mm (1mm=0.0394")

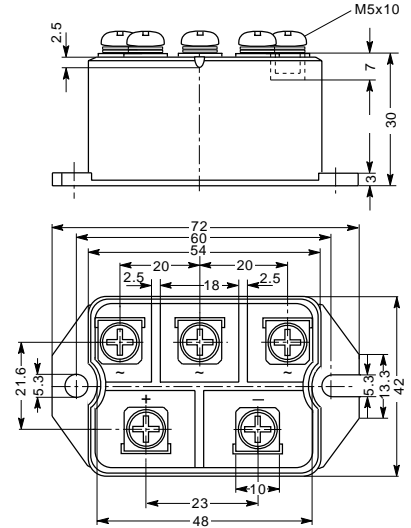

Symbol	Test Conditions	Maximum Ratings	Unit
$I_{dAV}$	$T_C=110^{\circ}C$ , module	50	A
$I_{dAV}$	$T_A=45^{\circ}C$ ( $R_{thCA}=0.6K/W$ ), module	40	
$I_{FSM}$	$T_{VJ}=45^{\circ}C$ $V_R=0$ t=10ms (50Hz), sine t=8.3ms (60Hz), sine	460 500	A
	$T_{VJ}=T_{VJM}$ $V_R=0$ t=10ms(50Hz), sine t=8.3ms(60Hz), sine	420 460	
$I^2t$	$T_{VJ}=45^{\circ}C$ $V_R=0$ t=10ms (50Hz), sine t=8.3ms (60Hz), sine	1270 1270	$A^2s$
	$T_{VJ}=T_{VJM}$ $V_R=0$ t=10ms(50Hz), sine t=8.3ms(60Hz), sine	1040 1040	
$T_{VJ}$ $T_{VJM}$ $T_{stg}$		-40...+150 150 -40...+125	$^{\circ}C$
$V_{ISOL}$	50/60Hz, RMS $I_{ISOL} \leq 1mA$ t=1min t=1s	2500 3000	V~
$M_d$	Mounting torque (M5) Terminal connection torque (M5)	$5 \pm 15\%$ $5 \pm 15\%$	Nm
Weight	typ.	160	g

# S3PDB50

## Three Phase Rectifier Modules

Symbol	Test Conditions	Characteristic Values	Unit
$I_R$	$V_R=V_{RRM}; T_{VJ}=25^{\circ}\text{C}$ $V_R=V_{RRM}; T_{VJ}=T_{VJM}$	$\leq 0.3$ $\leq 5$	mA
$V_F$	$I_F=150\text{A}; T_{VJ}=25^{\circ}\text{C}$	$\leq 1.8$	V
$V_{TO}$	For power-loss calculations only	0.8	V
$r_T$	$T_{VJ}=T_{VJM}$	8	$\text{m}\Omega$
$R_{thJC}$	per diode per module	1.45 0.24	K/W
$R_{thJK}$	per diode per module	1.87 0.31	K/W
$d_s$	Creeping distance on surface	10	mm
$d_A$	Creepage distance in air	9.4	mm
$a$	Max. allowable acceleration	50	$\text{m/s}^2$

### FEATURES

- \* Package with screw terminals
- \* Isolation voltage 3000 V~
- \* Planar passivated chips
- \* Blocking voltage up to 1800 V
- \* Low forward voltage drop

### APPLICATIONS

- \* Supplies for DC power equipment
- \* Input rectifiers for PWM inverter
- \* Battery DC power supplies
- \* Field supply for DC motors

### ADVANTAGES

- \* Easy to mount with two screws
- \* Space and weight savings
- \* Improved temperature and power cycling