



AKD4341-SB

AK4341 Evaluation Board Rev.0

General Description

AKD4341-SB is an evaluation board for AK4341 (192kHz sampling 24Bit $\Delta\Sigma$ DAC). AKD4341-SB has a digital audio interface (AK4113) of Optical or COAX input and can easily achieve the interface with digital audio system. Therefore, it is easy to evaluate the sound quality of AK4341.

■ **Ordering Guide**

AKD4341-SB ---- AK4341 Evaluation Board

Function

- On-board digital audio interface. (AK4113)

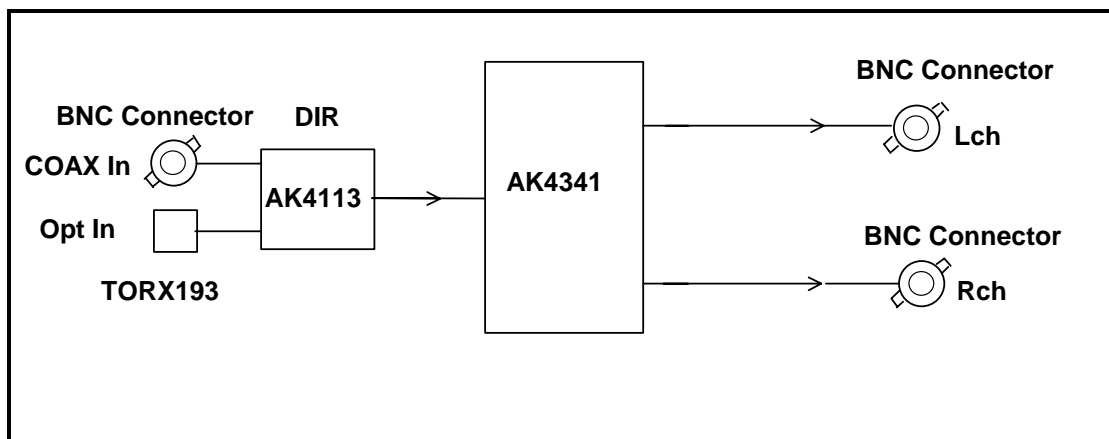

Figure 1. AKD4341-SB Block diagram
 (* Circuit diagram are attached at the end of this manual.)

COAX is recommended for an evaluation of the Sound quality.

■ Operation sequence

1) Set up the power supply lines. (See “Other jumpers set-up”.)

Name of jack	Color of jack	Voltage	Used for	Comments and attention	Default setting
+9V (J4)	Red	+12~+15V	HVDD of AK4341, Regulator T1	This jack should be always connected to power supply.	+9V
+5V (J5)	Red	+4.5~+5.5V	TVDD of AK4113, Logic circuit	This jack should be always connected to power supply.	+5V
+3.3V (J6)	Red	+2.7~+3.6V	AVDD and DVDD of AK4341, Logic circuit	This jack should be always connected to power supply.	+3.3V
GND (J7)	Black	0V	GND	This jack should be always connected to power supply.	0V
GND (J8)	Black	0V	GND	This jack is used when the ground is separated. Please set 0Ω jumper of R28 from R31 properly.	open

Table 1. Set up of power supply lines

Each supply line should be distributed from the power supply unit.

2) Set-up the jumper pins

3) Set-up the DIP switches. (See the followings.)

4) Power on

The AK4341 should be reset once by bringing SW3 (PDN) “L” upon power-up.

■ Evaluation mode

1. Using DIR (COAX) (default)

It is possible to evaluate the AK4341 by using CD disk. The DIR generates MCLK, BICK, LRCK and SDATA from the received data through BNC connector (J3). Setting of jumper is shown below.

COAX is recommended for an evaluation of the Sound quality.

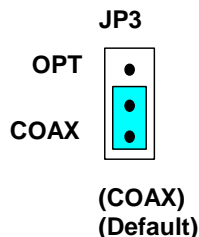

Figure 2. Jumper setting, when using DIR (COAX) (default)

2. Using DIR (Optical Link)

It is possible to evaluate the AK4341 by using CD disk. The DIR generates MCLK, BICK, LRCK and SDATA from the received data through optical connector (PORT3: TORX193). Setting of jumper is shown below.

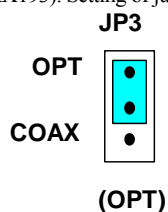

Figure 3. Jumper setting, when using DIR (Optical Link)

3. All clocks are fed through the PORT1.

Change the resistance as below.

R5: 5.1Ω → open

R6, R7, R8: 100Ω → open

R1, R2, R3, R4: open → 100Ω or short (0Ω)

■ Setting of DIP switch

[SW1]: AK4113 setting

No.	Pin	OFF	ON	Default
1	OCKS1	AK4113 Master Clock setting Refer to Table4		ON
2	OCKS0			OFF

Table 2. SW1 setting

[SW2]: AK4341 setting

No.	Pin	OFF	ON	Default
1	ACKS	Manual Setting Mode	Auto Setting Mode	ON
2	DIF	Audio data format : MSB justified	Audio data format : I ² S Compatible	OFF
3	DEM	De-emphasis filter : “Disable”	De-emphasis filter : “Enable”	OFF
4	-	-	-	-

Table 3. SW2 setting

The frequency of the master clock output is set by OCKS0 and OCKS1 as shown in Table 4.

OCKS1	OCKS0	MCLK Frequency
0	0	256fs @fs=88.2/96kHz
1	0	512fs @ fs=32/44.1/48kHz
1	1	128fs @ fs=176.4/192kHz

Default

Table 4. MCLK Clock

■ Setting of SW3 (Setting of PDN of AK4341)

[SW3](PDN): Reset of AK4341. Select "H" during operation.

■ Setting of SW4 (Setting of SMUTE of AK4341)

[SW4](SMUTE): Soft-mute of AK4341. Soft-mute is executed during pushed.

■ Setting of jumper pin JP1 (Setting of GAIN of AK4341)

[JP1](GAIN): Output level of AOUTL/AOUTR pin of AK4341 can be selected by jumper pin JP1 (GAIN).
(For further details, please refer to datasheet of AK4341.)

GAIN (JP1)	GAIN
L	0dB (Default)
H	+6dB
Open	+12dB

Table 5. Setting of output level of AOUTL/AOUTR pin of AK4341

Measurement Result

[Measurement condition]

- Measurement unit : Audio Precision SYS-2722 (192K)
- MCLK : 512fs (fs=44.1kHz), 256fs (fs=96KHz), 128fs (fs=192KHz)
- BICK : 64fs
- fs : 44.1kHz, 96KHz, 192KHz
- BW : 20Hz~20kHz (fs=44.1kHz), 20Hz~40kHz (fs=96kHz, 192KHz)
- Resolution : 24bit
- Power Supply : VDD=+5V, HVEE=-5V
- Interface : AK4113 (fs=44.1kHz, 96KHz, 192KHz)
- Temperature : Room Temp
- GAIN : L

fs=44.1kHz

Parameter	Input signal	Measurement filter	Lch Results	Rch Results
S/(N+D)	1kHz, 0dB	20kLPF	91.6 dB	92.0 dB
S/(N+D)	1kHz, -60dB	20kLPF	38.3 dB	38.0 dB
DR	1kHz, -60dB	20kLPF, A-weighted	101.7 dB	101.2 dB
S/N	"0" data	20kLPF, A-weighted	102.2 dB	101.2 dB

fs=96kHz

Parameter	Input signal	Measurement filter	Lch Results	Rch Results
S/(N+D)	1kHz, 0dB	40kLPF	91.9 dB	92.6 dB
S/(N+D)	1kHz, -60dB	40kLPF	37.3 dB	36.7 dB
DR	1kHz, -60dB	40kLPF, A-weighted	102.2 dB	101.2 dB
S/N	"0" data	40kLPF, A-weighted	102.2 dB	101.7 dB

fs=192kHz

Parameter	Input signal	Measurement filter	Lch Results	Rch Results
S/(N+D)	1kHz, 0dB	40kLPF	93.2 dB	93.2 dB
S/(N+D)	1kHz, -60dB	40kLPF	36.4 dB	36.2dB
DR	1kHz, -60dB	40kLPF, A-weighted	101.6 dB	100.7 dB
S/N	"0" data	40kLPF, A-weighted	102.2 dB	101.1 dB

■ Plots

[Measurement Condition]

- Measurement Unit : Audio Precision SYS-2722 (192KHz)
- MCLK : 512fs (fs=44.1kHz), 256fs (fs=96kHz), 128fs (fs=192kHz)
- BICK : 64fs
- fs : 44.1kHz, 96kHz, 192kHz
- BW : 20Hz~20kHz (fs=44.1kHz), 40Hz~40kHz (fs=96kHz), 80Hz~80kHz (fs=192kHz)
- Resolution : 24bit
- Power Supply : VDD=+5V, HVEE=-5V
- Interface : AK4113 (44.1kHz, 96kHz, 192kHz)
- Temperature : Room Temp
- GAIN : L

fs=48kHz

- Figure 8. FFT (Input Frequency =1kHz, Input Level =0dBFS)
- Figure 9. FFT (Input Frequency =1kHz, Input Level =-60dBFS)
- Figure 10. FFT (noise floor)
- Figure 11. FFT (out-of-band noise)
- Figure 12. THD+N vs Input Level (Input Frequency =1kHz)
- Figure 13. THD+N vs Input Frequency (Input Level=0dBFS)
- Figure 14. Linearity (Input Frequency =1kHz)
- Figure 15. Frequency Response (Input Level=0dBFS)
- Figure 16. Cross-talk (Input Level=0dBFS)

fs=96kHz

- Figure 17. FFT (Input Frequency =1kHz, Input Level =0dBFS)
- Figure 18. FFT (Input Frequency =1kHz, Input Level =0dBFS,Notch-on)
- Figure 19. FFT (Input Frequency =1kHz, Input Level =-60dBFS)
- Figure 20. FFT (noise floor)
- Figure 21. FFT (out-of-band noise)
- Figure 22. THD+N vs Input Level (Input Frequency =1kHz)
- Figure 23. THD+N vs f_{in} (Input Level=0dBFS)
- Figure 24. Linearity (Input Frequency =1kHz)
- Figure 25. Frequency Response (Input Level=0dBFS)
- Figure 26. Cross-talk (Input Level=0dBFS)

fs=192kHz

- Figure 27. FFT (Input Frequency =1kHz, Input Level =0dBFS)
- Figure 28. FFT (Input Frequency =1kHz, Input Level =0dBFS,Notch-on)
- Figure 29. FFT (Input Frequency =1kHz, Input Level =-60dBFS)
- Figure 30. FFT (noise floor)
- Figure 31. FFT (out-of-band noise)
- Figure 32. THD+N vs Input Level (Input Frequency =1kHz)
- Figure 33. THD+N vs f_{in} (Input Level=0dBFS)
- Figure 34. Linearity (Input Frequency =1kHz)
- Figure 35. Frequency Response (Input Level=0dBFS)
- Figure 36. Cross-talk (Input Level=0dBFS)

FFT point=16384, Avg=8, Window=Equiripple

(DAC fs=44.1kHz)

AKM

AK4341 FFT
HVDD=9V, VDD=3.3V, fs=44.1kHz, 0dBFS input

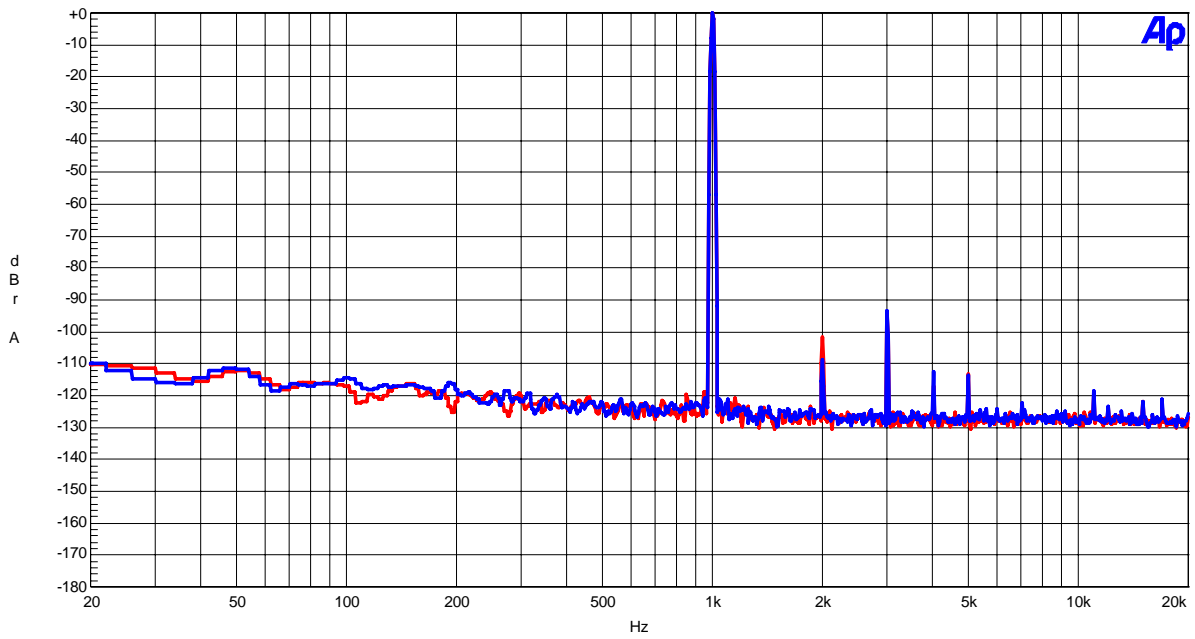

Figure 8. FFT(Input Frequency=1kHz, Input Level=0dBFS)

AKM

AK4341 FFT
HVDD=9V, VDD=3.3V, fs=44.1kHz, -60dBFS input

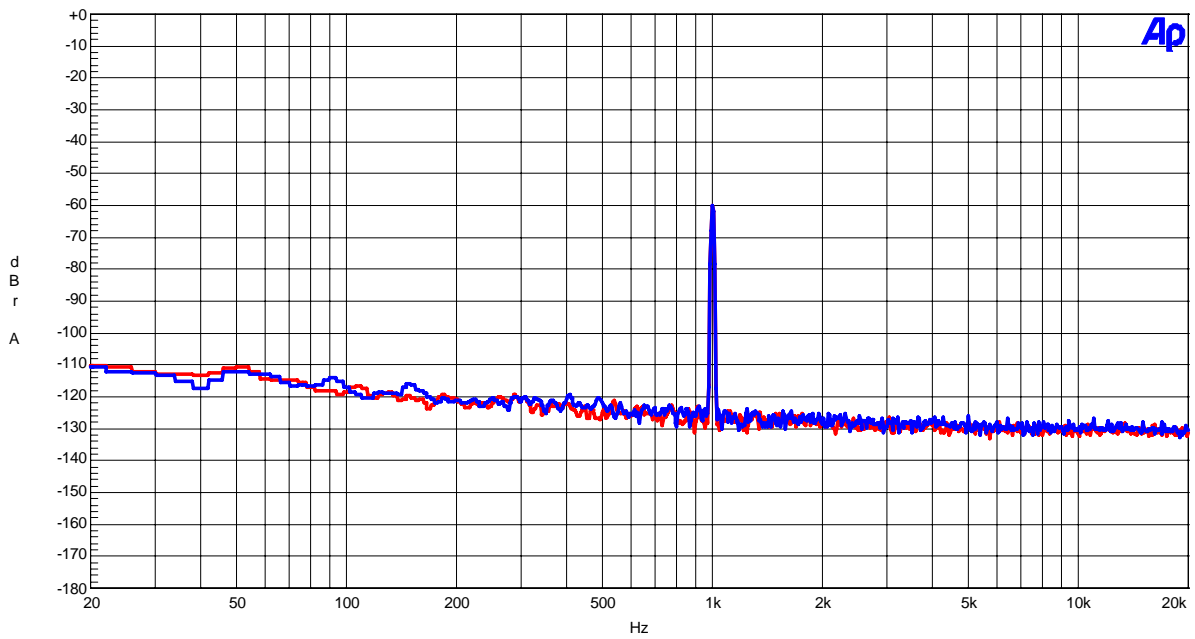

Figure 9. FFT(Input Frequency=1kHz, Input Level=-60dBFS)

(DAC fs=44.1kHz)

AKM

AK4341 FFT
HVDD=9V, VDD=3.3V, fs=44.1kHz, No signal input

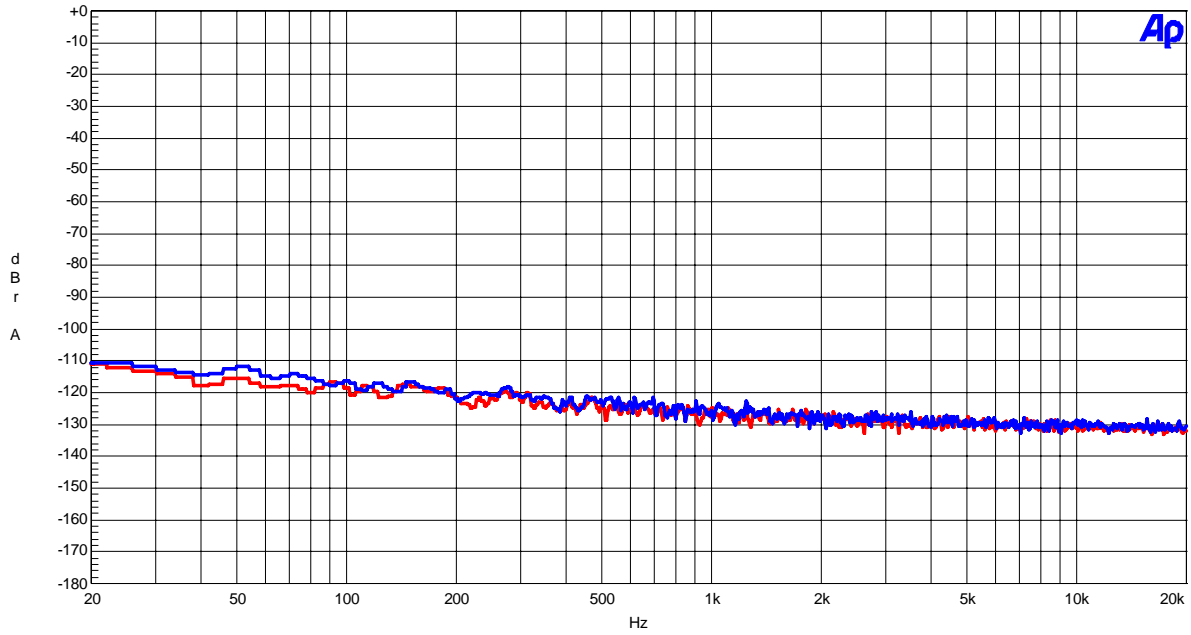

Figure 10. FFT(noise floor)

AKM

AK4341 FFT Out of band noise
HVDD=9V, VDD=3.3V, fs=44.1kHz, No signal input

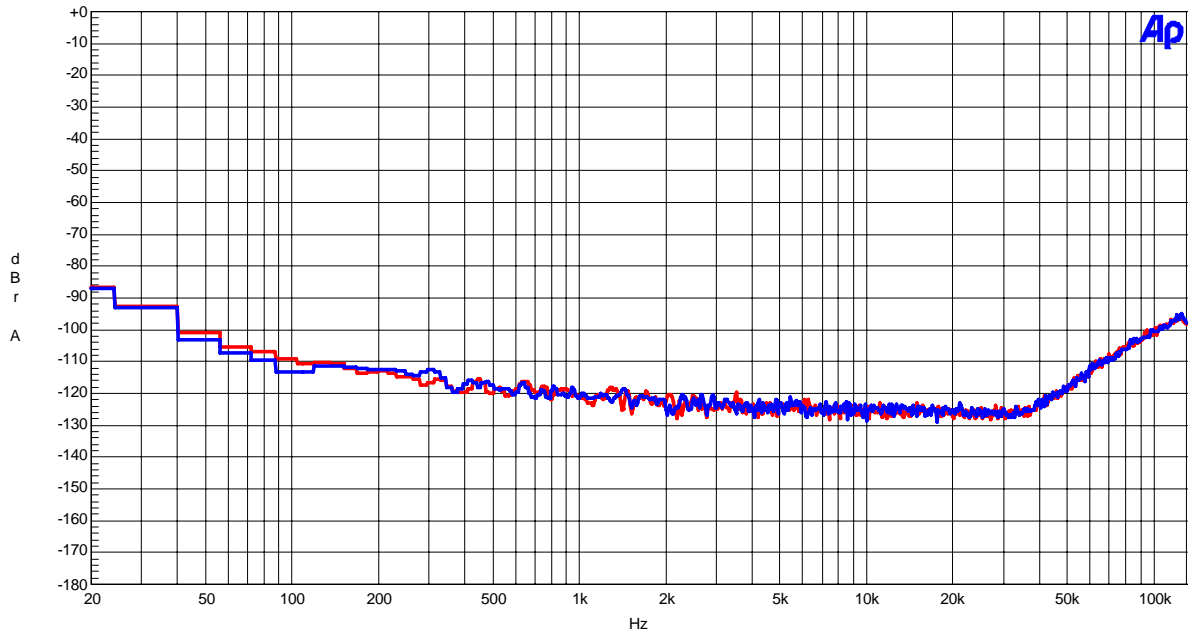

Figure 11. FFT(out-of-band noise)

(DAC fs=44.1kHz)

AKM

AK4341 THD+N vs. Input Level
 HVDD=9V, VDD=3.3V, fs=44.1kHz, fin=1kHz

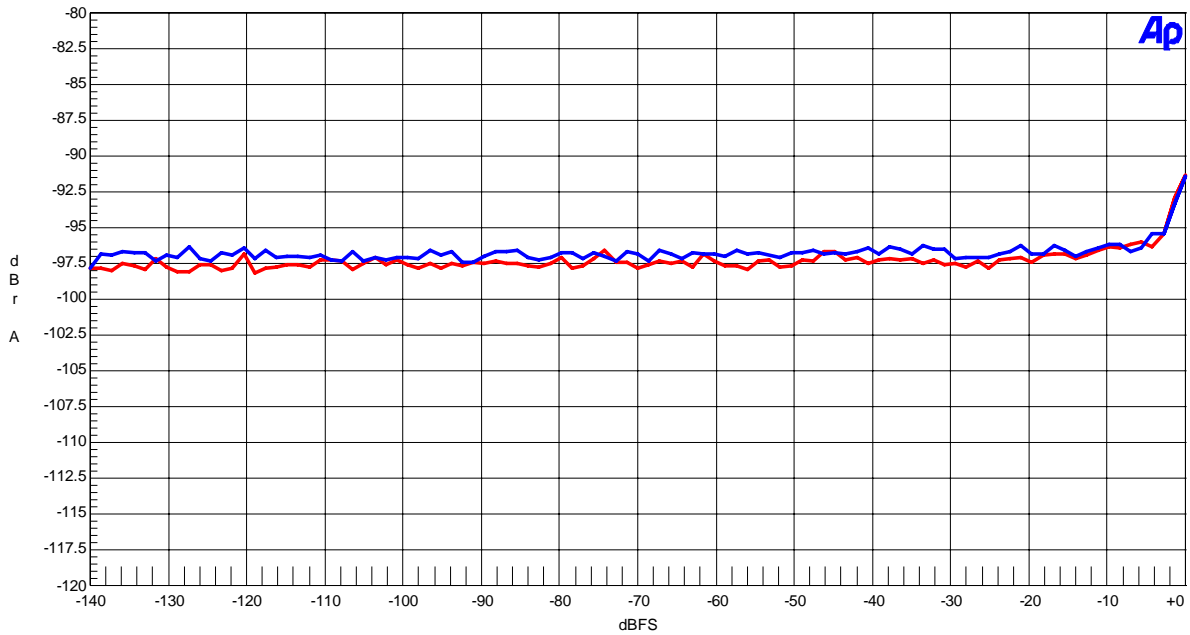

Figure 12. THD+N vs Input Level (Input Frequency=1kHz)

AKM

AK4341 THD+N vs. Input Frequency
 HVDD=9V, VDD=3.3V, fs=44.1kHz, 0dBFS input

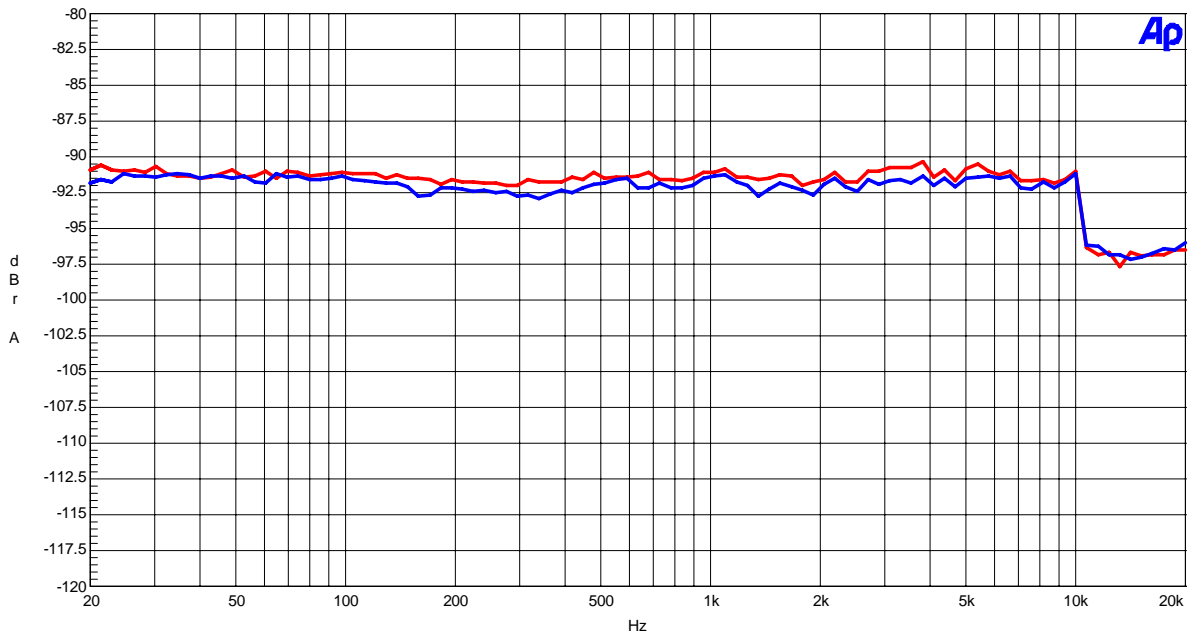

Figure 13. THD+N vs Input Frequency (Input Level=0dBFS)

(DAC fs=44.1kHz)

AKM

AK4341 Linearity
HVDD=9V, VDD=3.3V, fs=44.1kHz, fin=1kHz

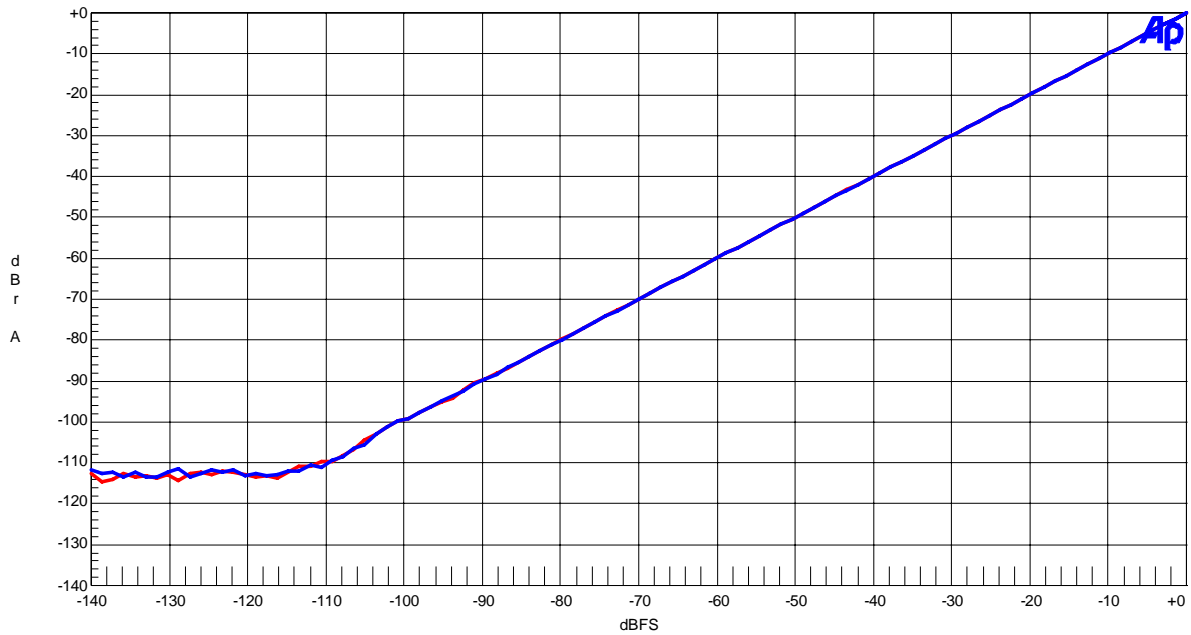

Figure 14. Linearity (Input Frequency=1kHz)

AKM

AK4341 Frequency Response
HVDD=9V, VDD=3.3V, fs=44.1kHz, 0dBFS input

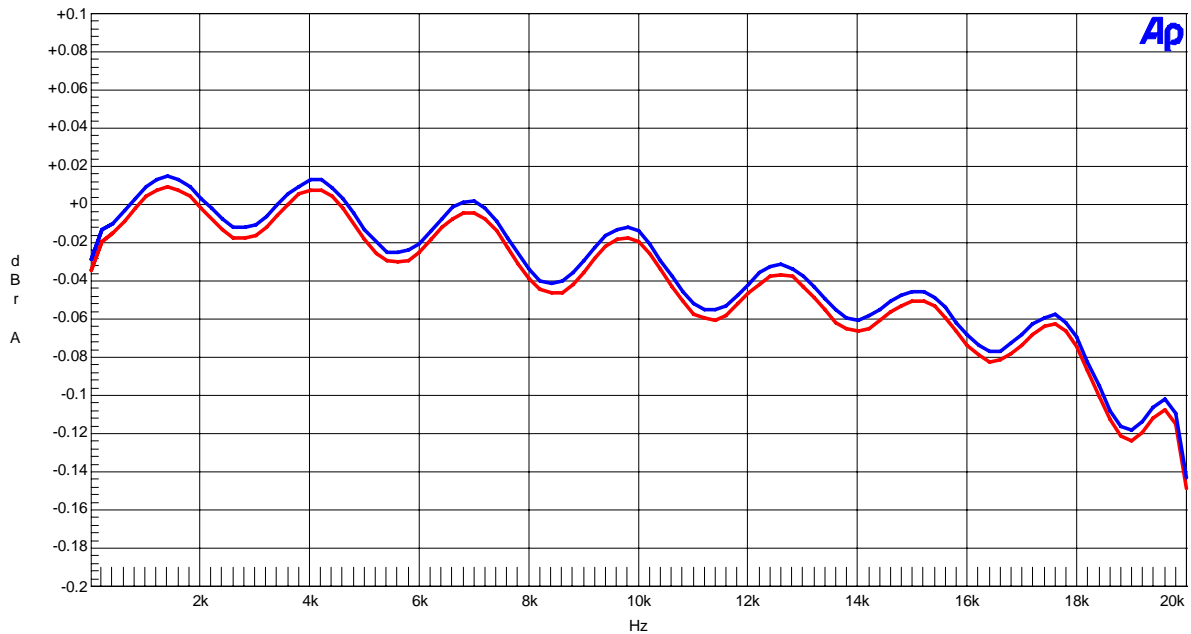

Figure 15. Frequency Response (Input Level=0dBFS)

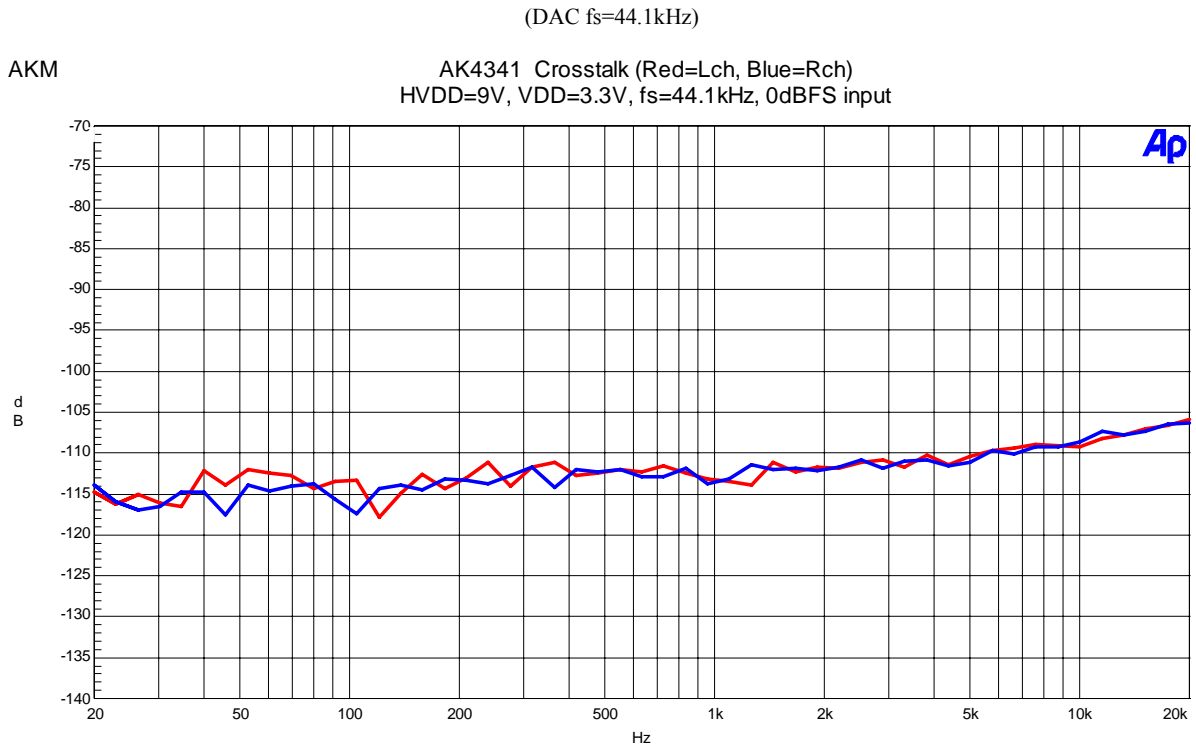

Figure 16. Cross-talk (Input Level=0dBFS)

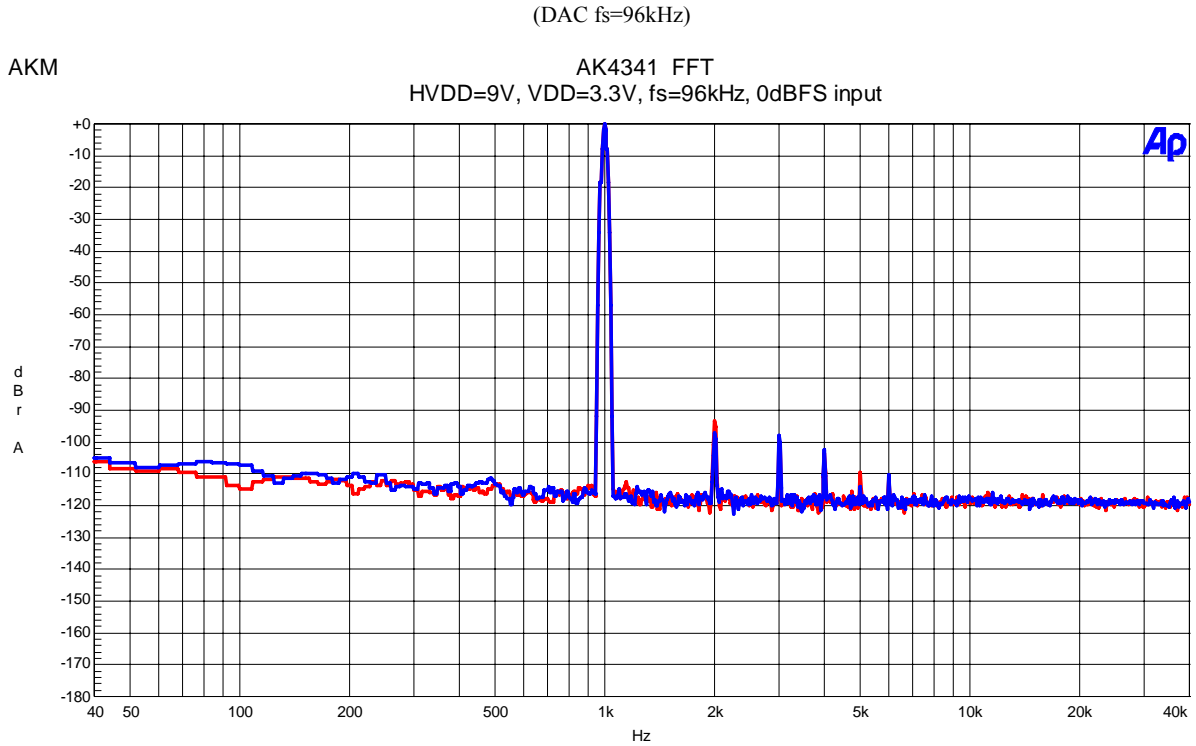

Figure 17. FFT(Input Frequency=1kHz, Input Level=0dBFS)

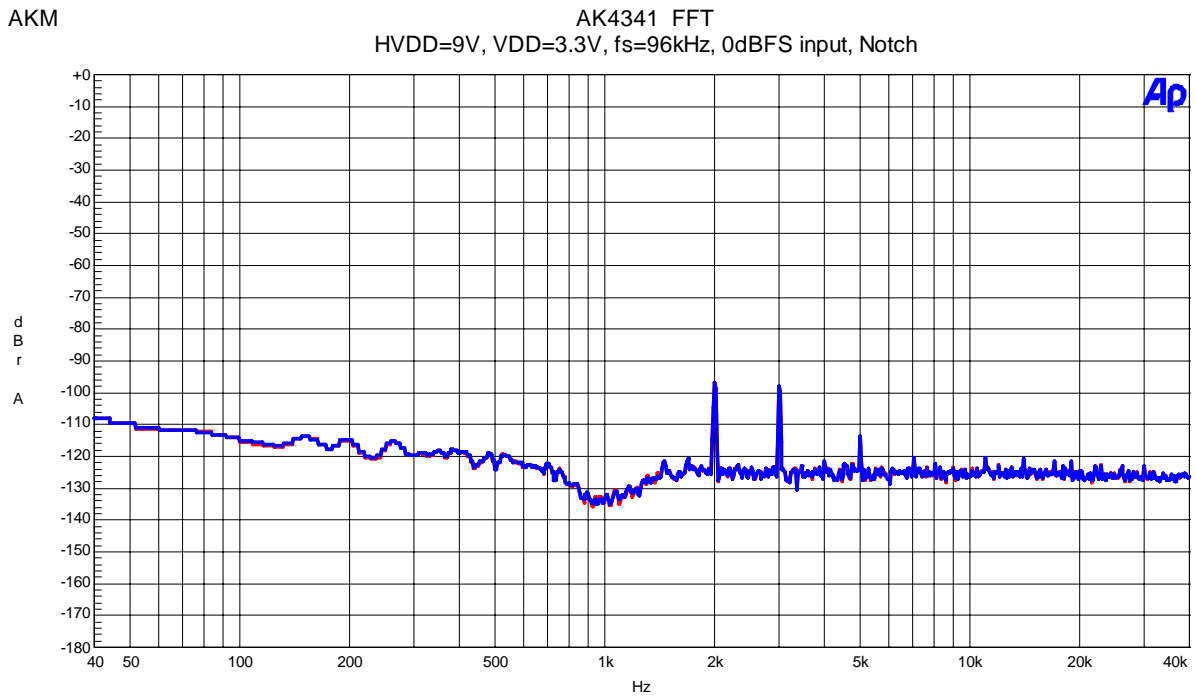

Figure 18. FFT(Input Frequency=1kHz, Input Level=0dBFS,Notch-on)

(DAC fs=96kHz)

AKM

AK4341 FFT
HVDD=9V, VDD=3.3V, fs=96kHz, -60dBFS input

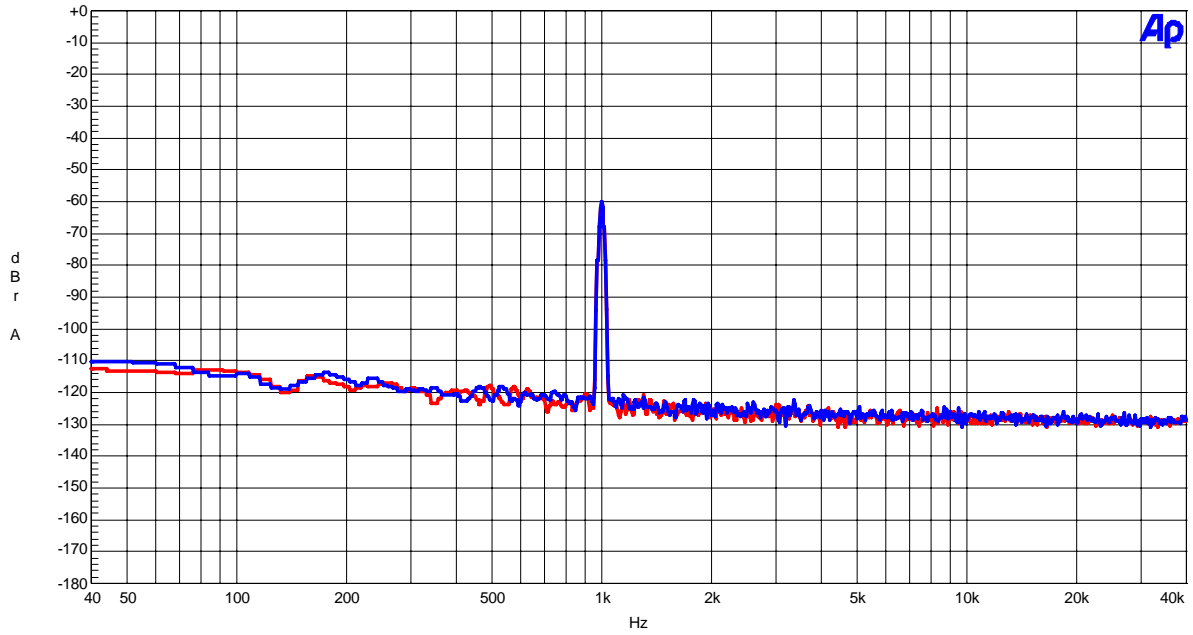

Figure 19. FFT(Input Frequency=1kHz, Input Level=-60dBFS)

AKM

AK4341 FFT
HVDD=9V, VDD=3.3V, fs=96kHz, No signal input

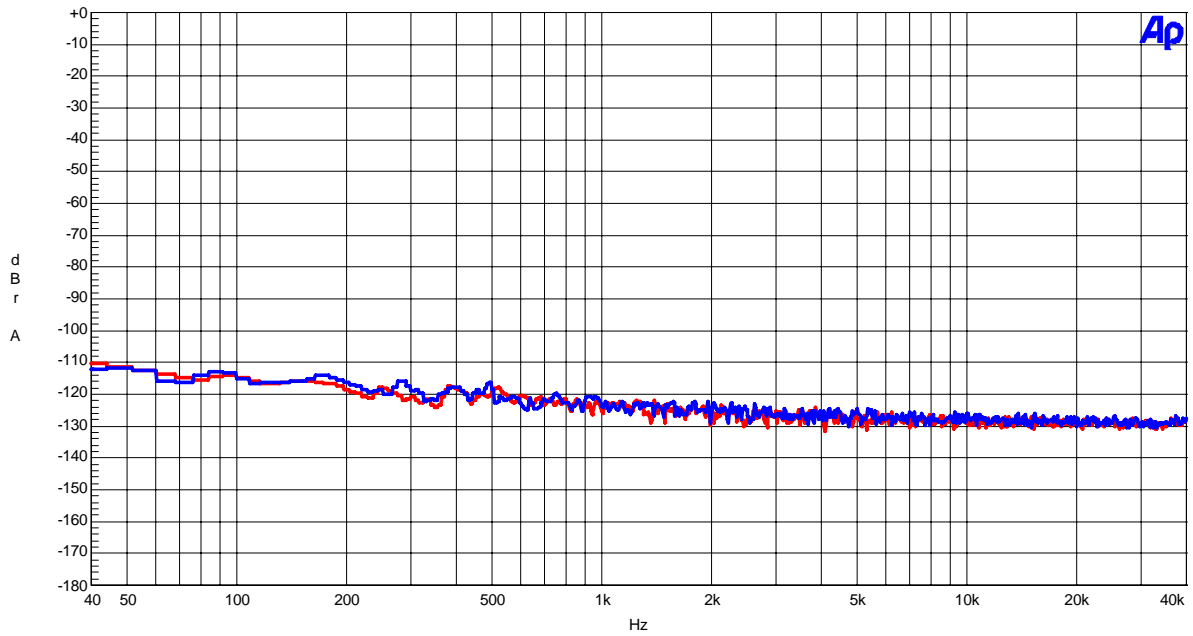

Figure 20. FFT(noise floor)

(DAC fs=96kHz)

AKM

AK4341 FFT Out of band noise
HVDD=9V, VDD=3.3V, fs=96kHz, No signal input

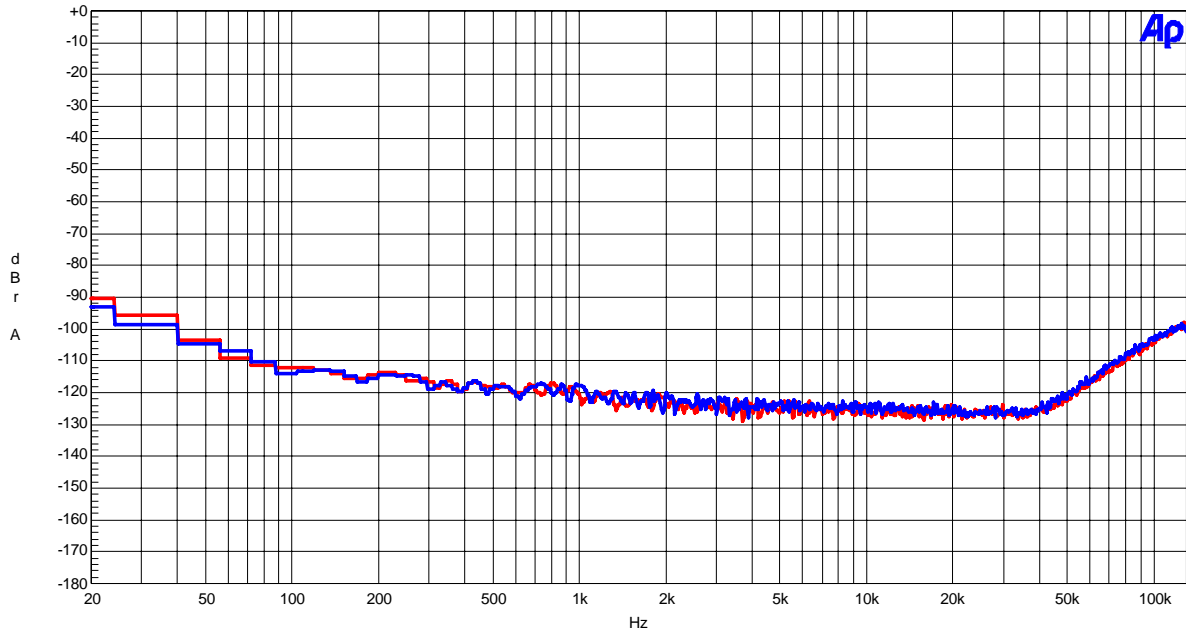

Figure 21. FFT (out-of-band noise)

AKM

AK4341 THD+N vs. Input Level
HVDD=9V, VDD=3.3V, fs=96kHz, fin=1kHz

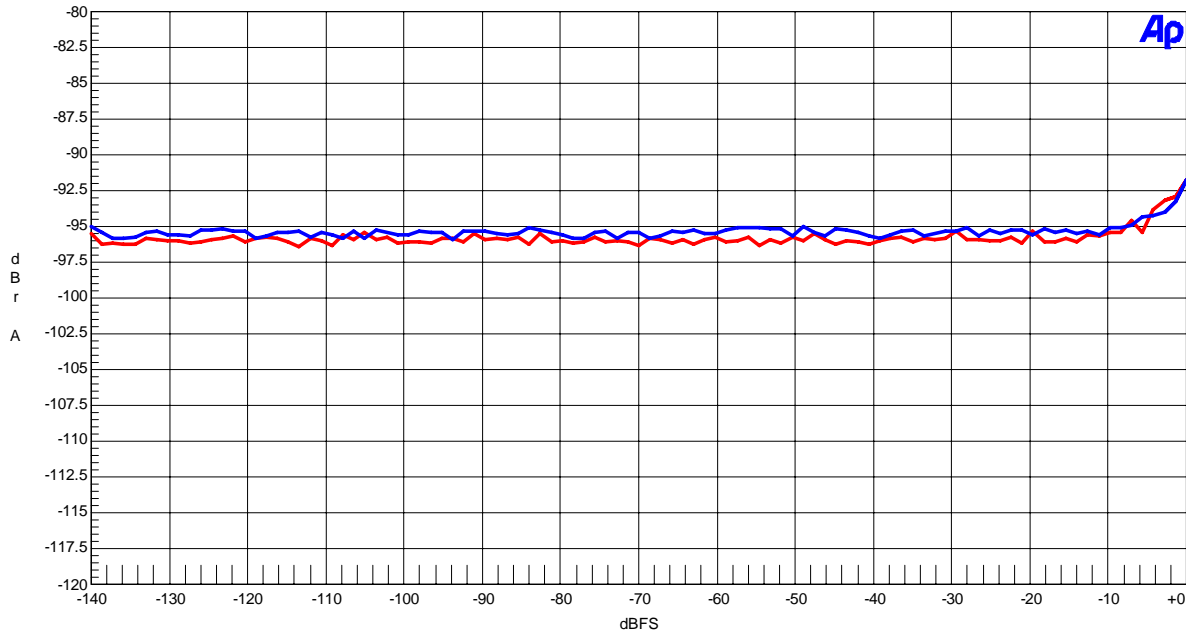

Figure 22. THD+N vs Input Level (Input Frequency=1kHz)

(DAC fs=96kHz)

AKM

AK4341 THD+N vs. Input Frequency
HVDD=9V, VDD=3.3V, fs=96kHz, 0dBFS input

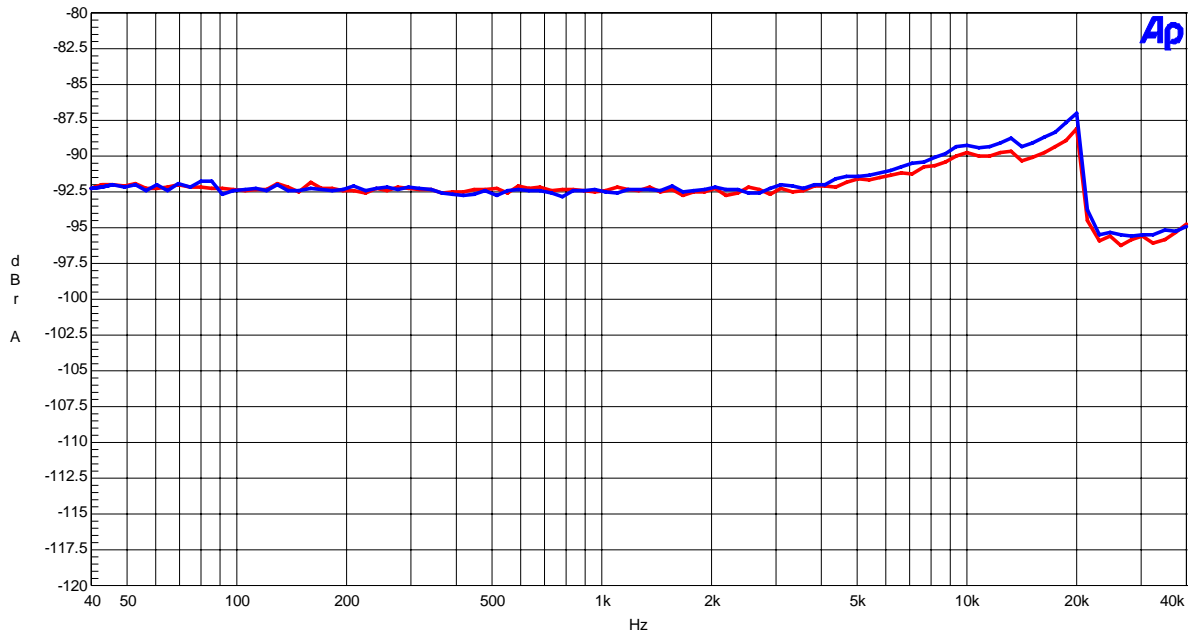

Figure 23. THD+N vs Input Frequency (Input Level=0dBFS)

AKM

AK4341 Linearity
HVDD=9V, VDD=3.3V, fs=96kHz, fin=1kHz

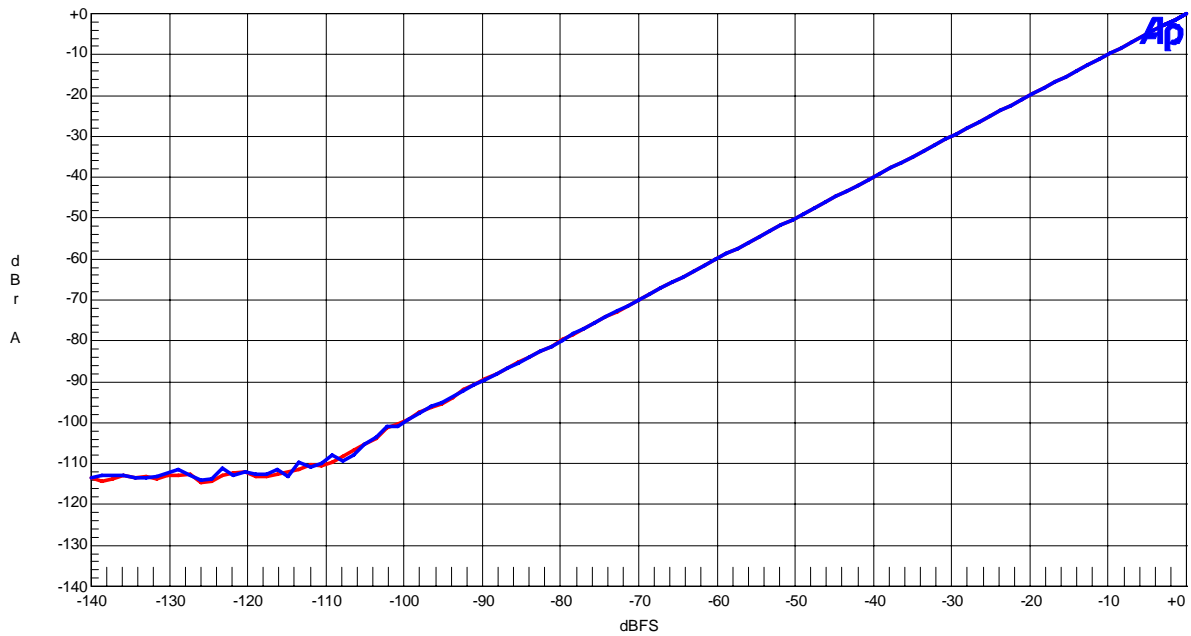

Figure 24. Linearity (Input Frequency=1kHz)

(DAC fs=96kHz)

AKM

AK4341 Frequency Response
HVDD=9V, VDD=3.3V, fs=96kHz, 0dBFS input

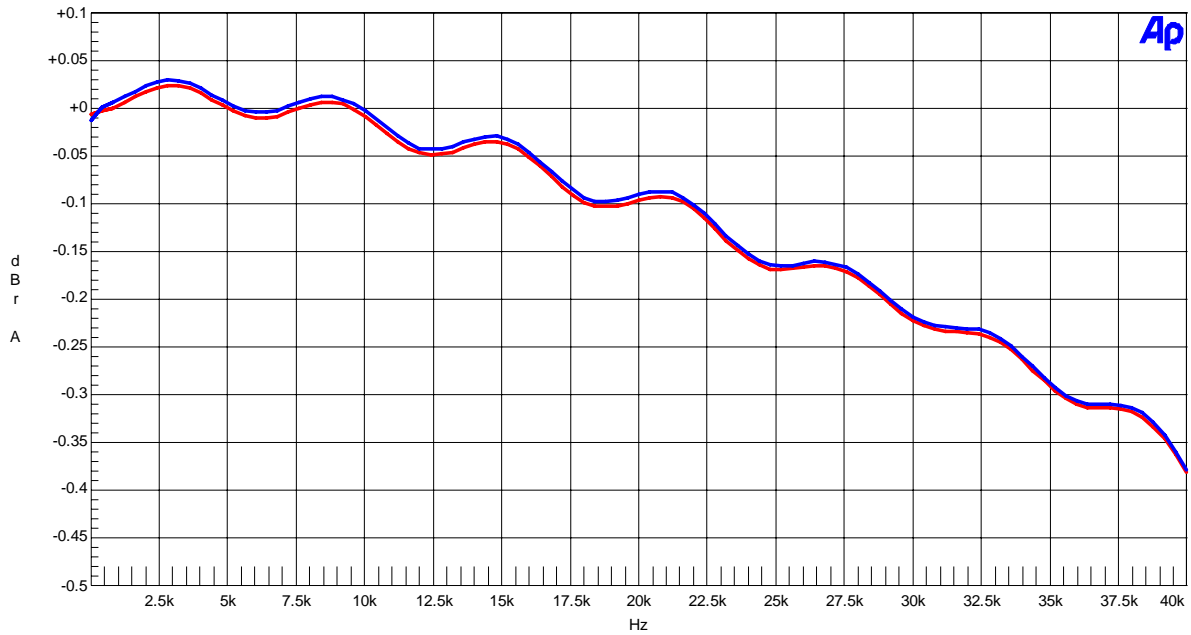

Figure 25. Frequency Response (Input Level=0dBFS)

AKM

AK4341 Crosstalk (Red=Lch, Blue=Rch)
HVDD=9V, VDD=3.3V, fs=96kHz, 0dBFS input

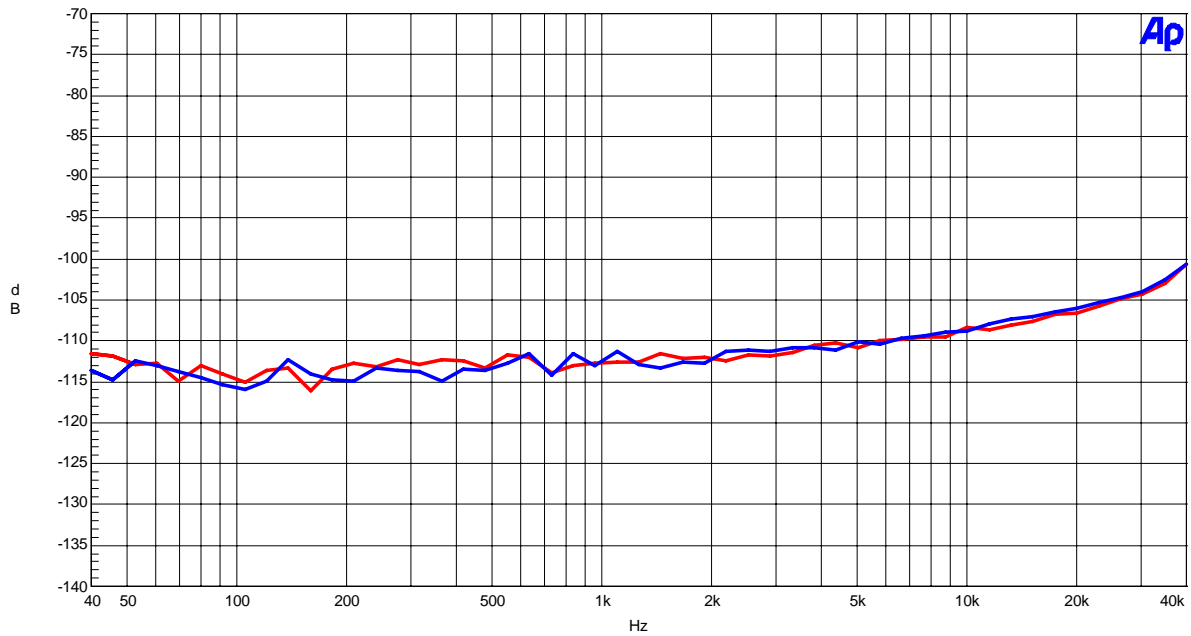

Figure 26. Cross-talk (Input Level=0dBFS)

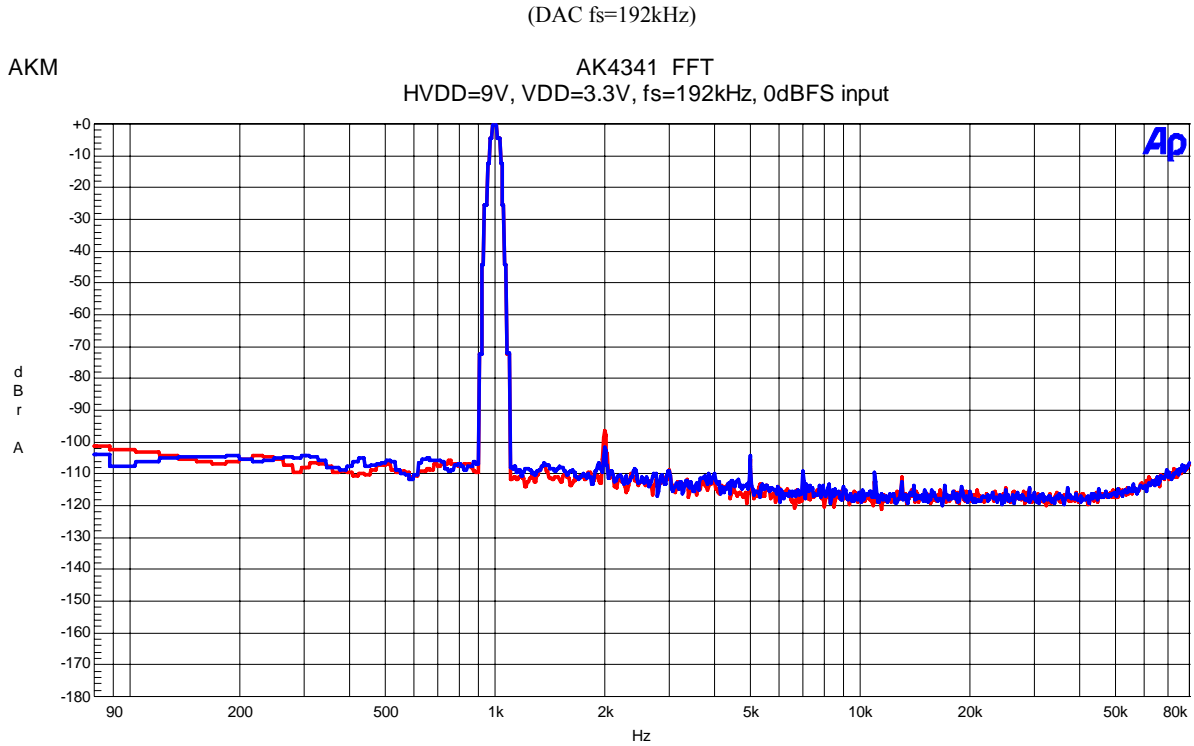

Figure 27. FFT(Input Frequency=1kHz, Input Level=0dBFS)

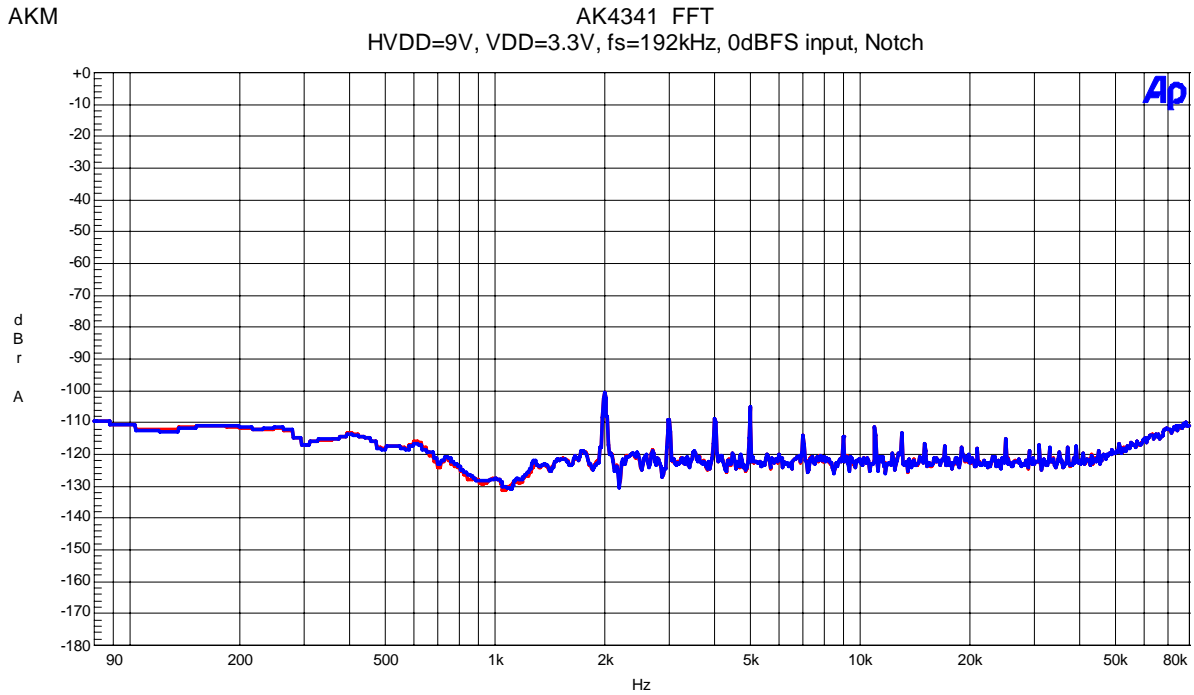

Figure 28. FFT(Input Frequency=1kHz, Input Level=0dBFS,Notch-on)

(DAC fs=192kHz)

AKM

AK4341 FFT
HVDD=9V, VDD=3.3V, fs=192kHz, -60dBFS input

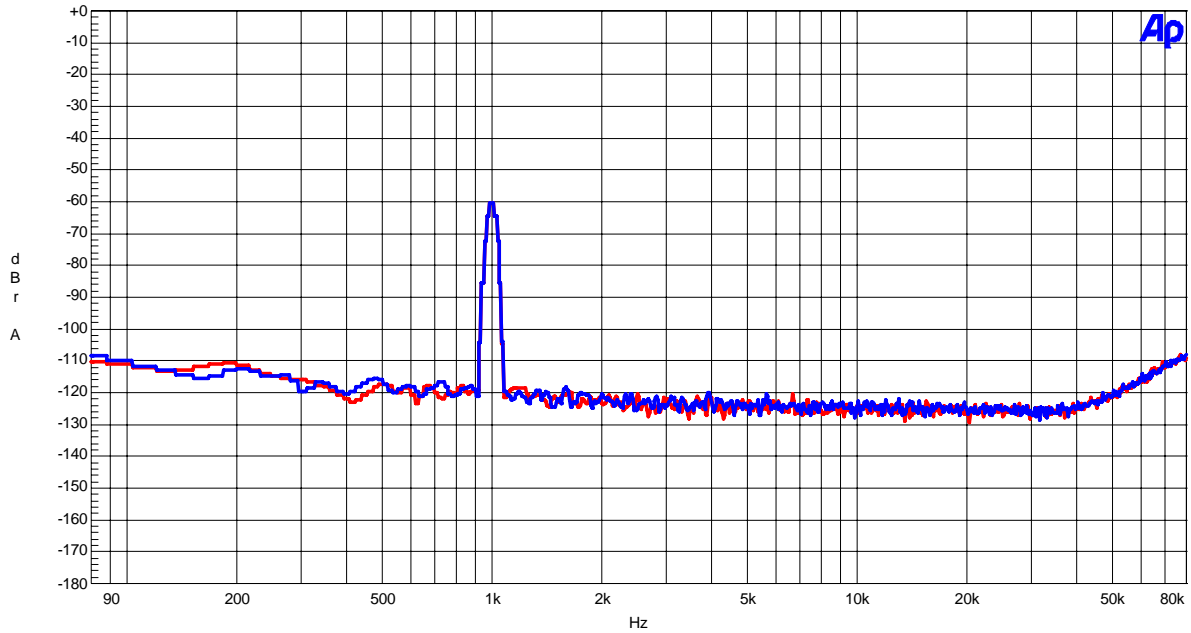

Figure 29. FFT(Input Frequency=1kHz, Input Level=-60dBFS)

AKM

AK4341 FFT
HVDD=9V, VDD=3.3V, fs=192kHz, No signal input

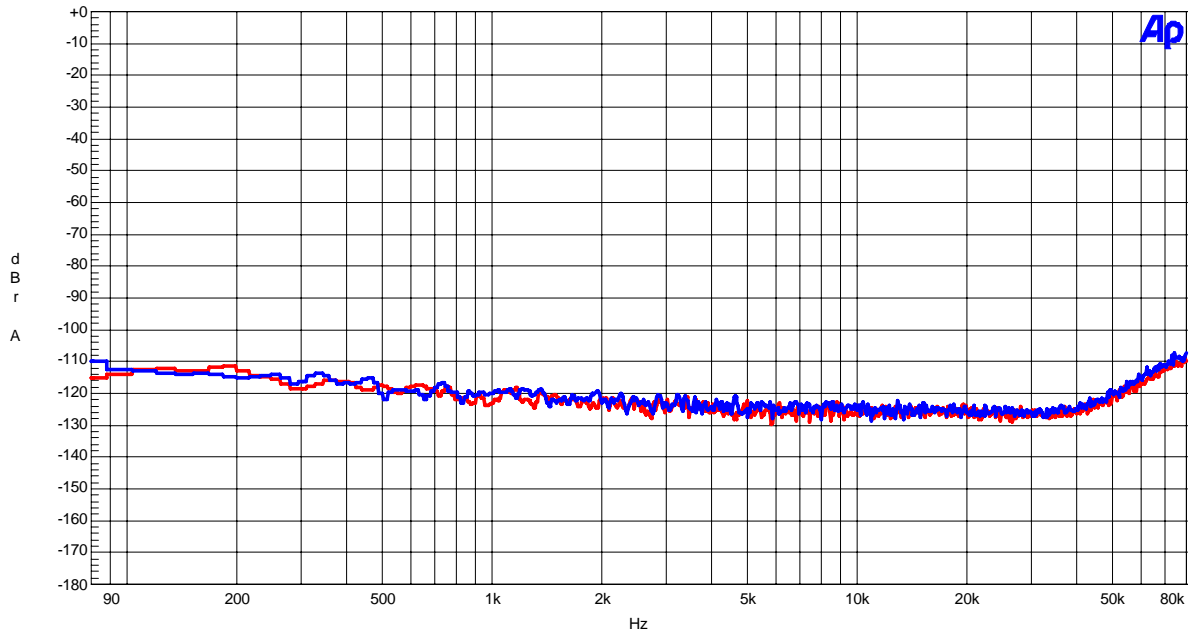

Figure 30. FFT(noise floor)

(DAC fs=192kHz)

AKM

AK4341 FFT Out of band noise
HVDD=9V, VDD=3.3V, fs=192kHz, No signal input

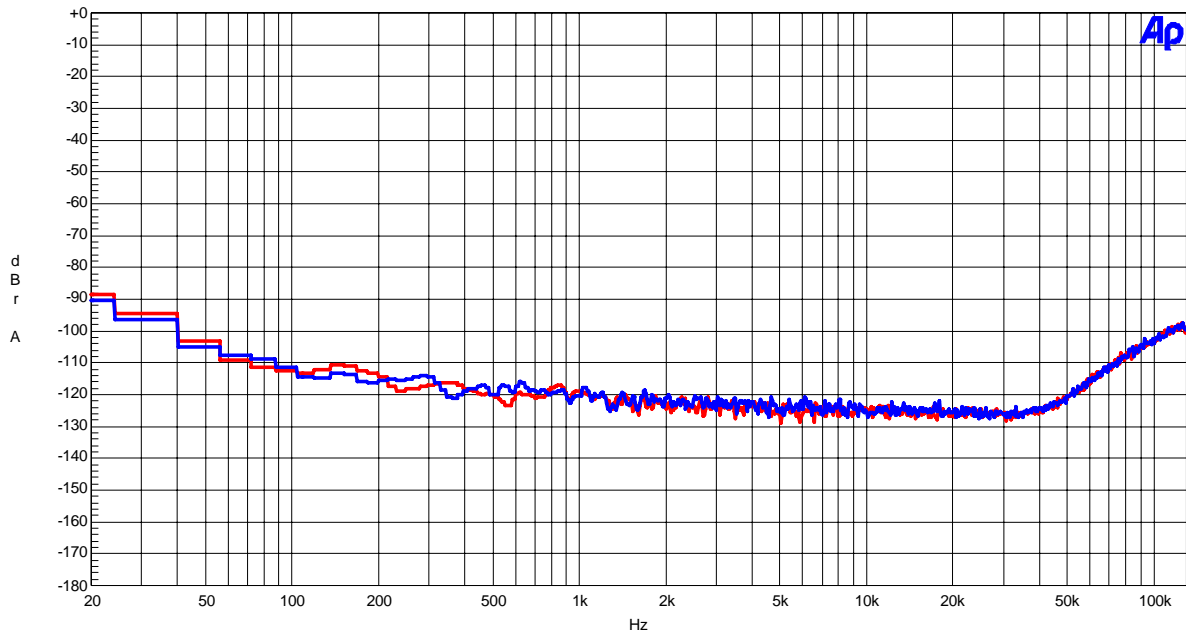

Figure 31. FFT(out-of-band noise)

AKM

AK4341 THD+N vs. Input Level
HVDD=9V, VDD=3.3V, fs=192kHz, fin=1kHz

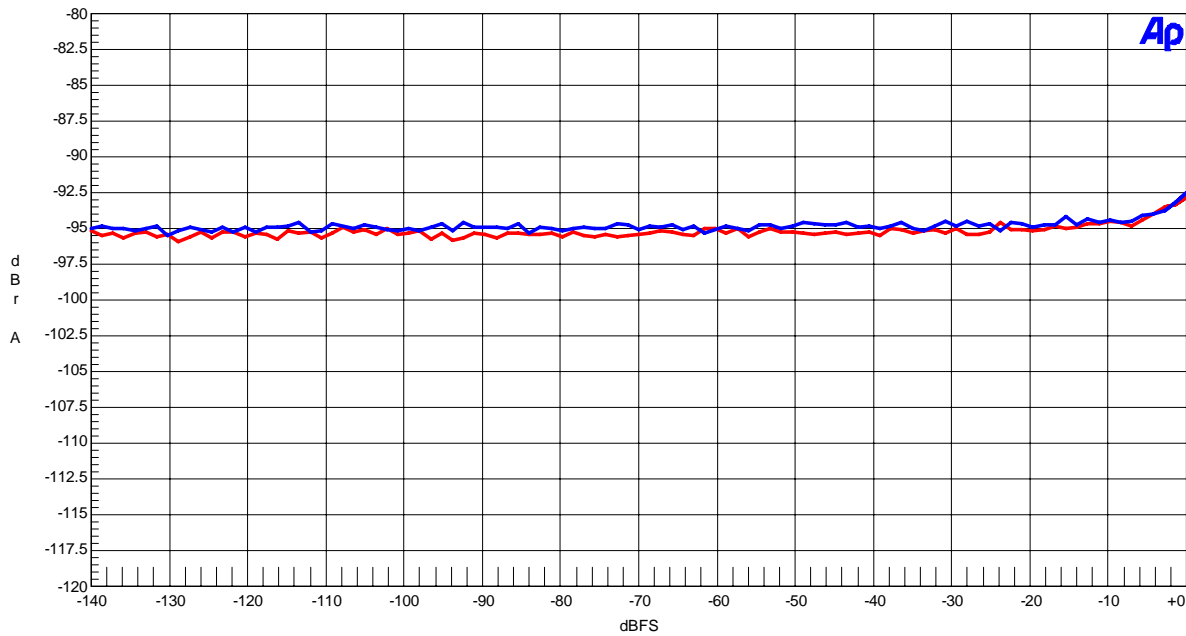

Figure 32. THD+N vs Input Level (Input Frequency=1kHz)

(DAC fs=192kHz)

AKM

AK4341 THD+N vs. Input Frequency
HVDD=9V, VDD=3.3V, fs=192kHz, 0dBFS input

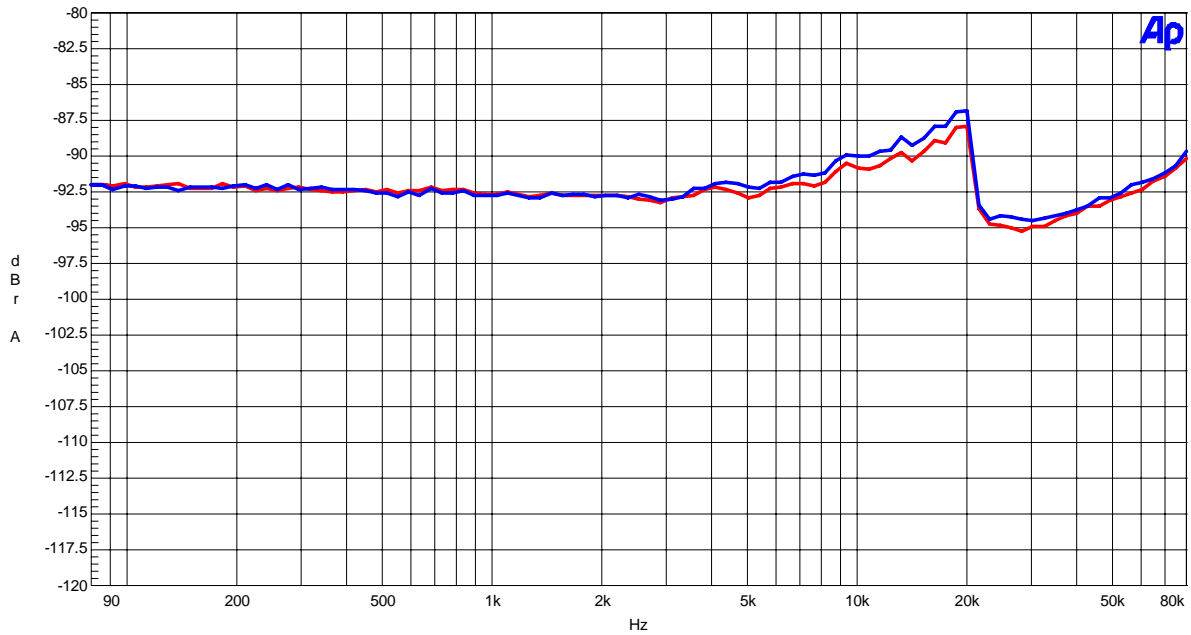

Figure 33. THD+N vs Input Frequency (Input Level=0dBFS)

AKM

AK4341 Linearity
HVDD=9V, VDD=3.3V, fs=192kHz, fin=1kHz

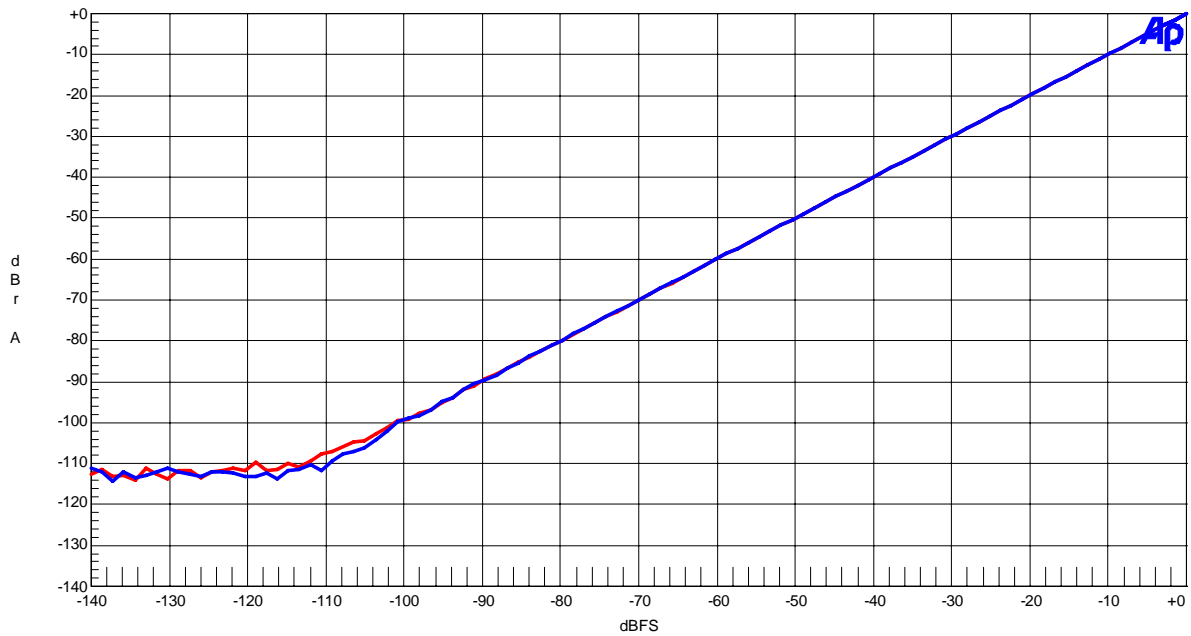

Figure 34. Linearity (Input Frequency=1kHz)

(DAC fs=192kHz)

AKM

AK4341 Frequency Response
HVDD=9V, VDD=3.3V, fs=192kHz, 0dBFS input

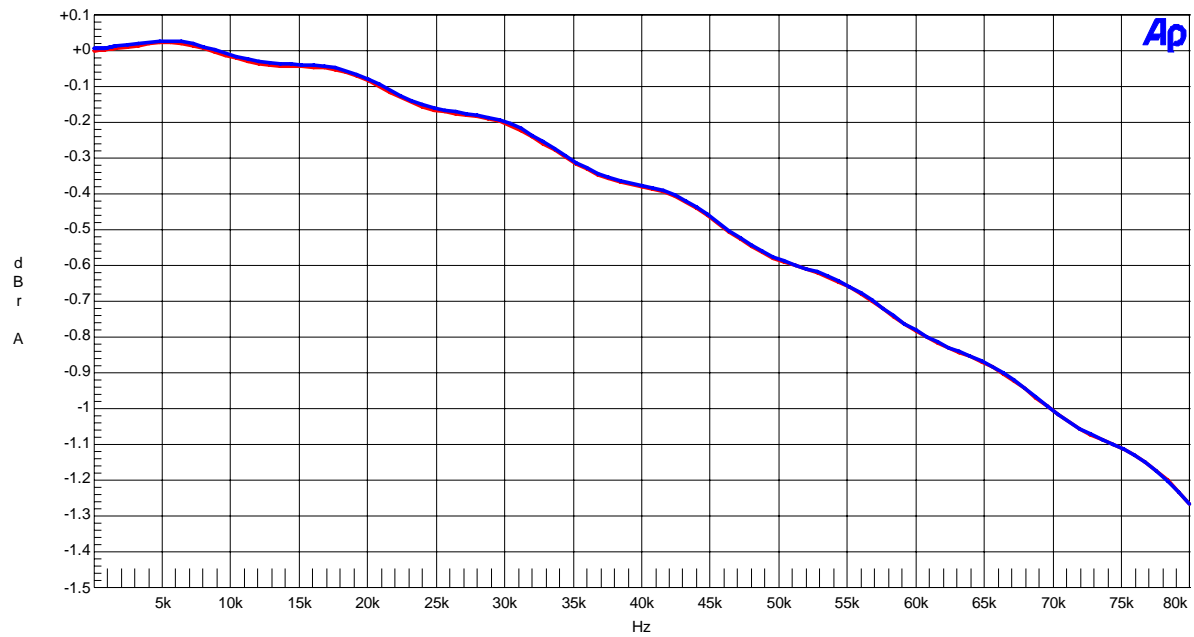

Figure 35. Frequency Response (Input Level=0dBFS)

AKM

AK4341 Crosstalk (Red=Lch, Blue=Rch)
HVDD=9V, VDD=3.3V, fs=192kHz, 0dBFS input

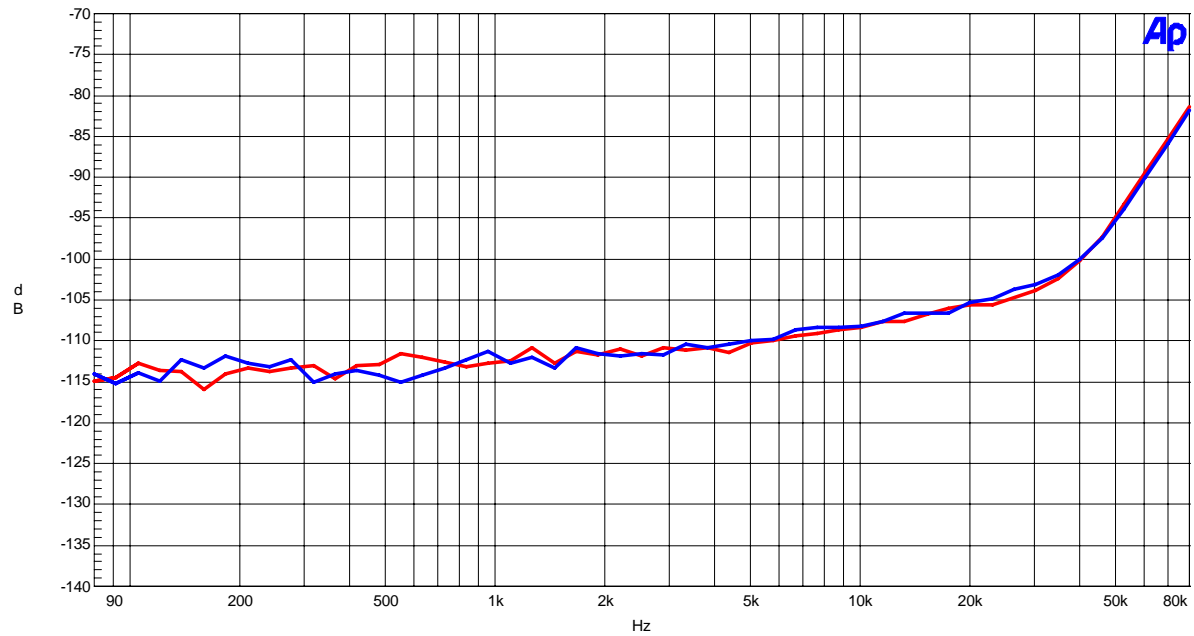

Figure 36. Cross-talk (Input Level=0dBFS)

Revision History

Date (YY/MM/DD)	Manual Revision	Board Revision	Reason	Contents
07/03/08	KM087300	0	First Edition	

IMPORTANT NOTICE

- These products and their specifications are subject to change without notice. Before considering any use or application, consult the Asahi Kasei Microsystems Co., Ltd. (AKM) sales office or authorized distributor concerning their current status.
- AKM assumes no liability for infringement of any patent, intellectual property, or other right in the application or use of any information contained herein.
- Any export of these products, or devices or systems containing them, may require an export license or other official approval under the law and regulations of the country of export pertaining to customs and tariffs, currency exchange, or strategic materials.
- AKM products are neither intended nor authorized for use as critical components in any safety, life support, or other hazard related device or system, and AKM assumes no responsibility relating to any such use, except with the express written consent of the Representative Director of AKM. As used here:
 - (a) A hazard related device or system is one designed or intended for life support or maintenance of safety or for applications in medicine, aerospace, nuclear energy, or other fields, in which its failure to function or perform may reasonably be expected to result in loss of life or in significant injury or damage to person or property.
 - (b) A critical component is one whose failure to function or perform may reasonably be expected to result, whether directly or indirectly, in the loss of the safety or effectiveness of the device or system containing it, and which must therefore meet very high standards of performance and reliability.
- It is the responsibility of the buyer or distributor of an AKM product who distributes, disposes of, or otherwise places the product with a third party to notify that party in advance of the above content and conditions, and the buyer or distributor agrees to assume any and all responsibility and liability for and hold AKM harmless from any and all claims arising from the use of said product in the absence of such notification.

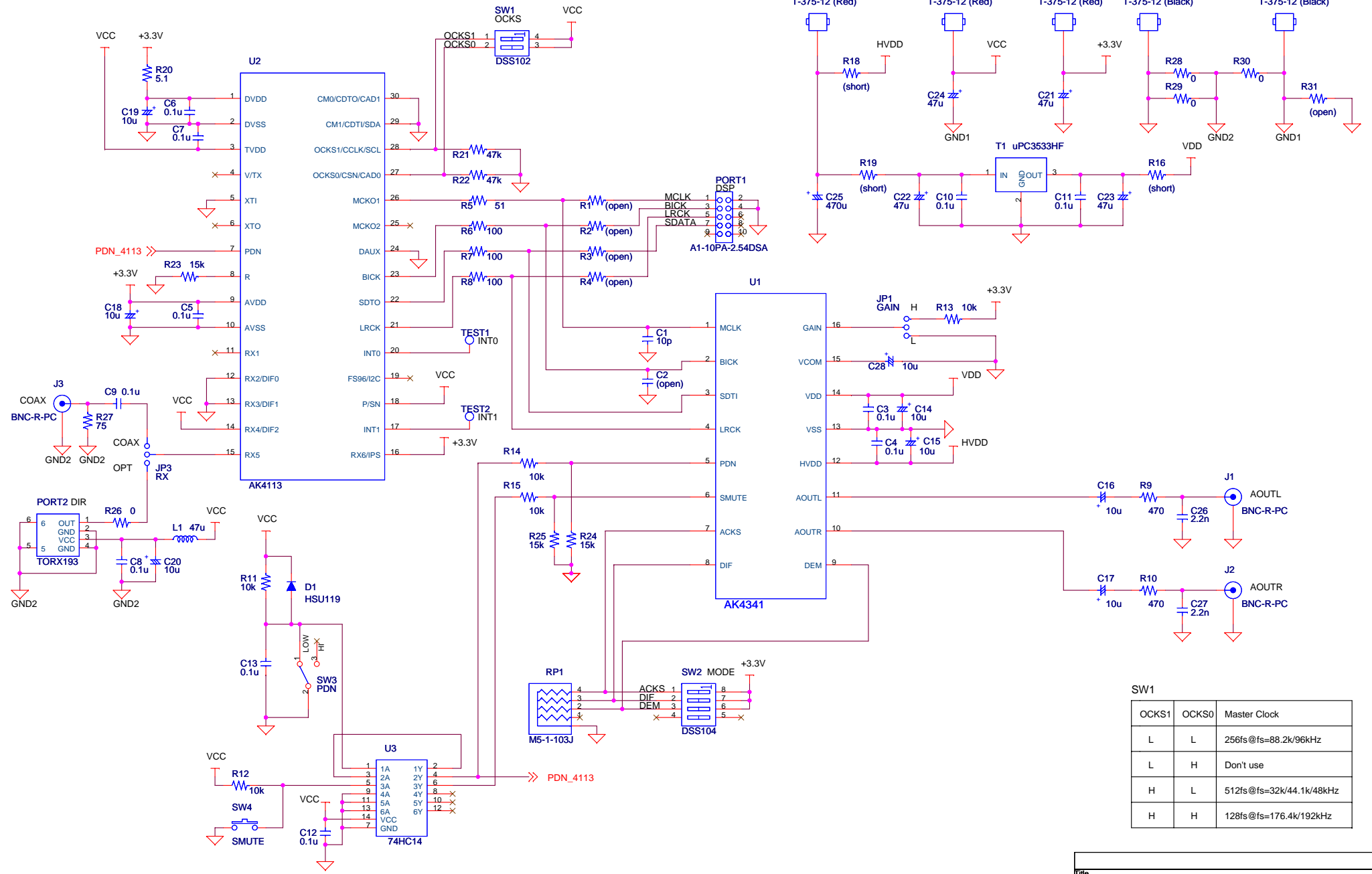

SW1

OCKS1	OCKS0	Master Clock
L	L	256fs@fs=88.2k/96kHz
L	H	Don't use
H	L	512fs@fs=32k/44.1k/48kHz
H	H	128fs@fs=176.4k/192kHz

Title		
AKD4341-SB		
Size	Document Number	Rev
A3	AKD4341-SB	0
Date:	Tuesday, February 06, 2007	Sheet 1 of 2