

SKT 1200



Capsule Thyristor

Line Thyristor

SKT 1200

Features

- Hermetic metal case with ceramic insulator
- Capsule package for double sided cooling
- International standard case
- Off-state and reverse voltages up to 1800 V
- Amplifying gate

Typical Applications

- DC motor control (e. g. for machine tools)
- Controlled rectifiers (e. g. for battery charging)
- AC controllers (e. g. for temperature control)
- Recommended snubber network e. g. for $V_{VRMS} \leq 400$ V:
 $R = 33 \Omega / 32$ W, $C = 1 \mu F$

V_{RSM} V	V_{RRM}, V_{DRM} V	$I_{TRMS} = 2800$ A (maximum value for continuous operation) $I_{TAV} = 1200$ A (sin. 180; DSC; $T_c = 85$ °C)	
1300	1200	SKT 1200/12E	
1500	1400	SKT 1200/14E	
1700	1600	SKT 1200/16E	
1900	1800	SKT 1200/18E	

Symbol	Conditions	Values	Units
I_{TAV}	sin. 180; $T_c = 100$ (85) °C;	840 (1200)	A
I_D	2 x P8/180F; $T_a = 35$ °C; B2 / B6	1440 / 2050	A
	2 x P19/190F; $T_a = 35$ °C; B2 / B6	1550 / 2200	A
I_{RMS}	2 x P8/180F; $T_a = 35$ °C; W1C	1600	A
I_{TSM}	$T_{vj} = 25$ °C; 10 ms	30000	A
	$T_{vj} = 125$ °C; 10 ms	25500	A
i^2t	$T_{vj} = 25$ °C; 8,3 ... 10 ms	4500000	A ² s
	$T_{vj} = 125$ °C; 8,3 ... 10 ms	3250000	A ² s
V_T	$T_{vj} = 25$ °C; $I_T = 3600$ A	max. 1,65	V
$V_{T(TO)}$	$T_{vj} = 125$ °C	max. 0,95	V
r_T	$T_{vj} = 125$ °C	max. 0,18	mΩ
I_{DD}, I_{RD}	$T_{vj} = 125$ °C; $V_{RD} = V_{RRM}, V_{DD} = V_{DRM}$	max. 100	mA
t_{gd}	$T_{vj} = 25$ °C; $I_G = 1$ A; $di_G/dt = 1$ A/μs	1	μs
t_{gr}	$V_D = 0,67 * V_{DRM}$	2	μs
$(di/dt)_{cr}$	$T_{vj} = 125$ °C	max. 125	A/μs
$(dv/dt)_{cr}$	$T_{vj} = 125$ °C	max. 1000	V/μs
t_q	$T_{vj} = 125$ °C,	100 ... 250	μs
I_H	$T_{vj} = 25$ °C; typ. / max.	250 / 500	mA
I_L	$T_{vj} = 25$ °C; $R_G = 33 \Omega$; typ. / max.	500 / 2000	mA
V_{GT}	$T_{vj} = 25$ °C; d.c.	min. 3	V
I_{GT}	$T_{vj} = 25$ °C; d.c.	min. 250	mA
V_{GD}	$T_{vj} = 125$ °C; d.c.	max. 0,25	V
I_{GD}	$T_{vj} = 125$ °C; d.c.	max. 10	mA
$R_{th(j-c)}$	cont.; DSC	0,021	K/W
$R_{th(j-c)}$	sin. 180; DSC / SSC	0,0225 / 0,054	K/W
$R_{th(j-c)}$	rec. 120; DSC / SSC	0,027 / 0,06	K/W
$R_{th(c-s)}$	DSC / SSC	0,005 / 0,01	K/W
T_{vj}		- 40 ... + 125	°C
T_{stg}		- 40 ... + 130	°C
V_{isol}		-	V~
F	mounting force	22 ... 25	kN
a			m/s ²
m	approx.	480	g
Case		B 14	



SKT

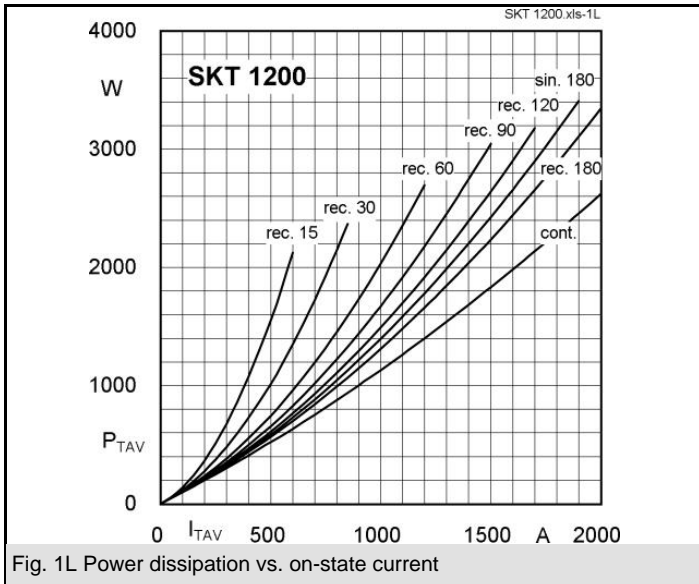

Fig. 1L Power dissipation vs. on-state current

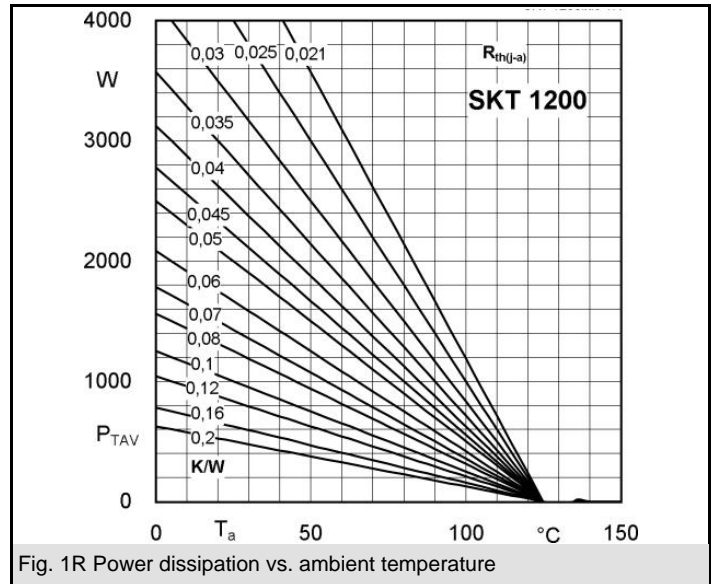

Fig. 1R Power dissipation vs. ambient temperature

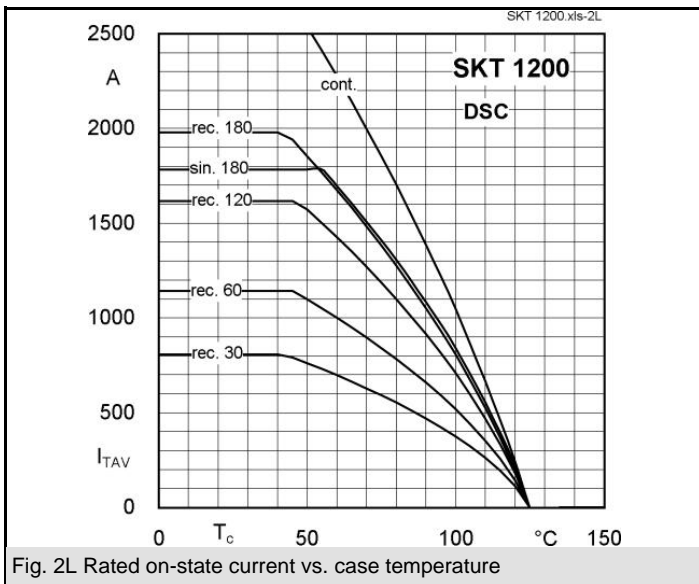

Fig. 2L Rated on-state current vs. case temperature

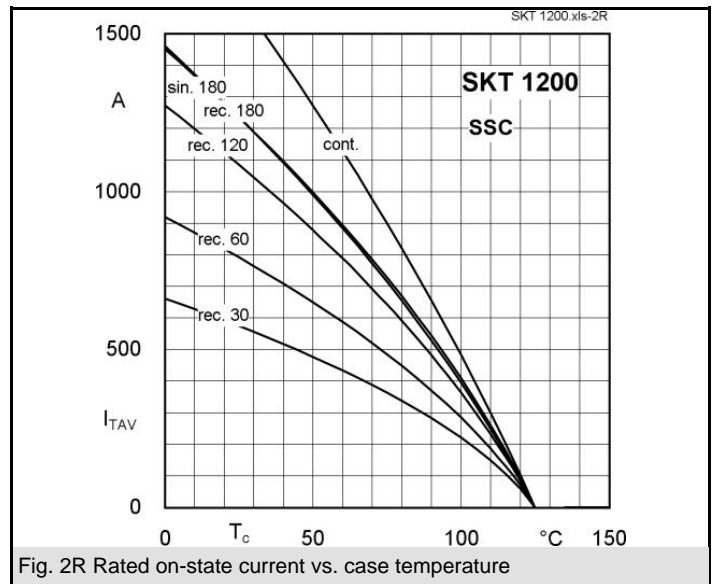

Fig. 2R Rated on-state current vs. case temperature

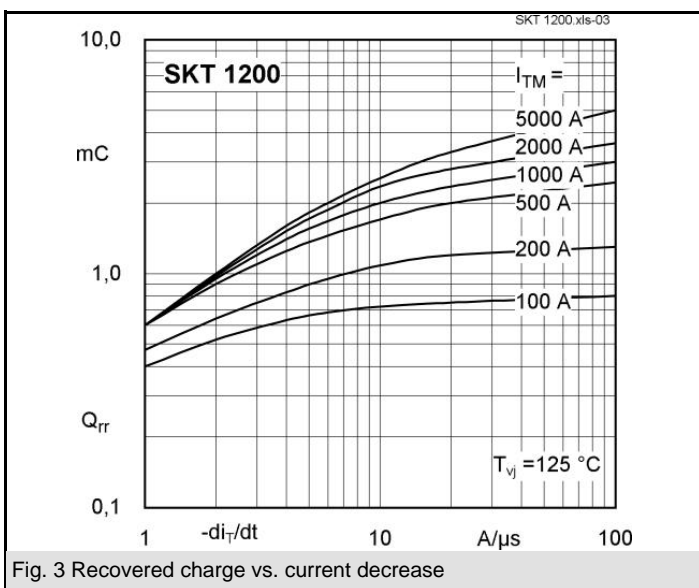

Fig. 3 Recovered charge vs. current decrease

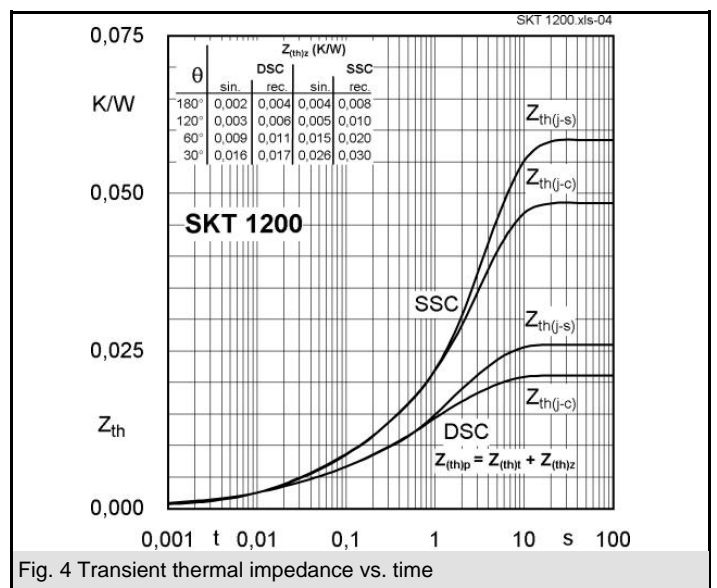
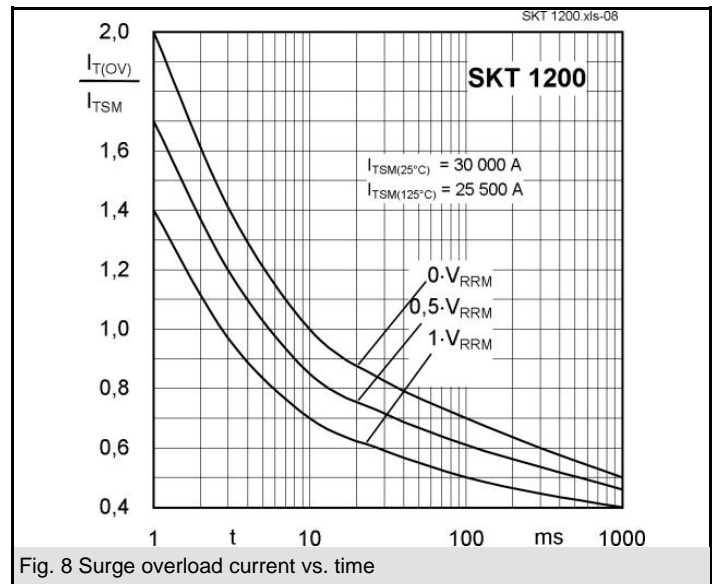
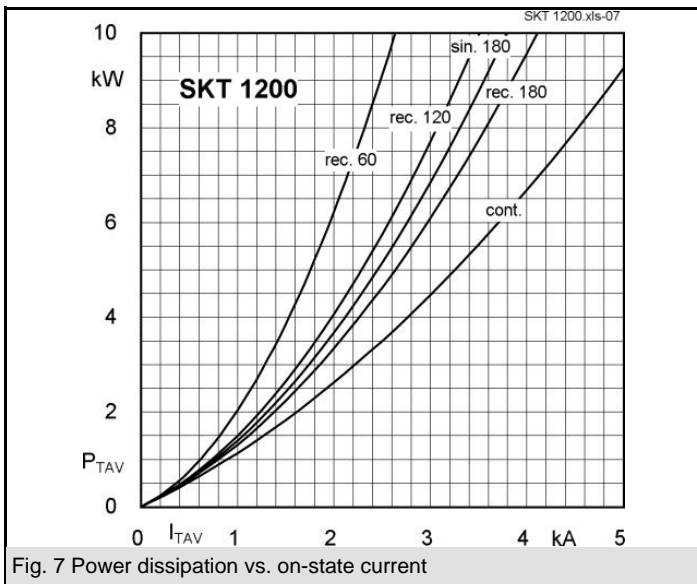
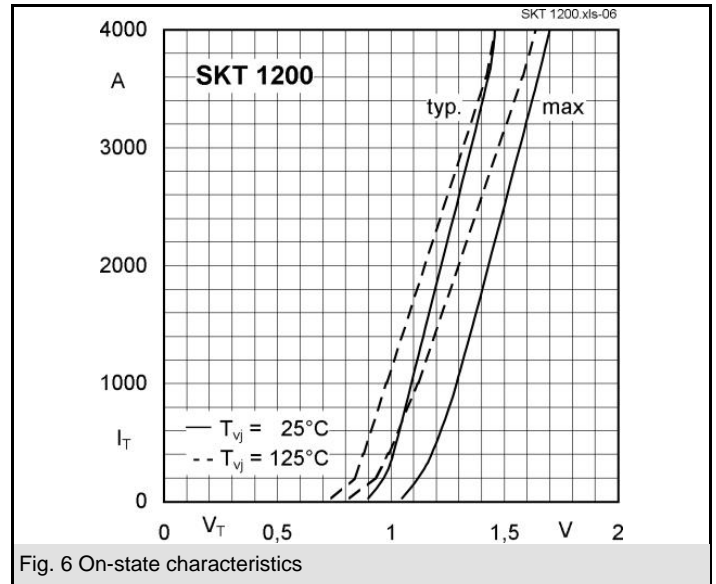
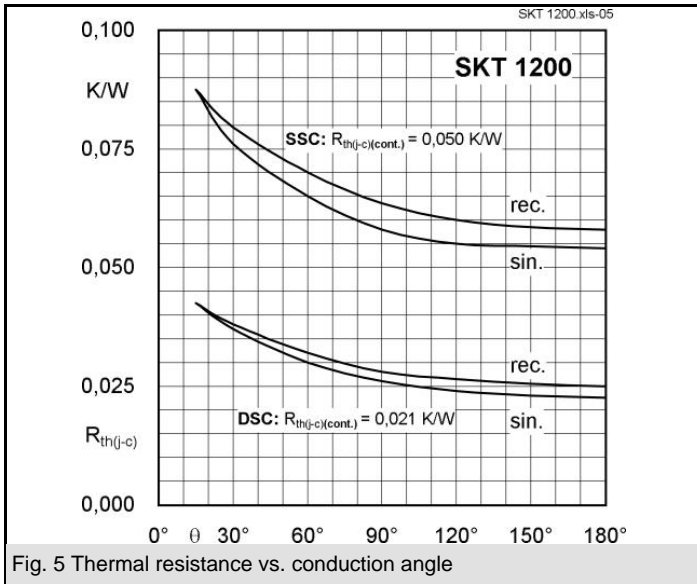
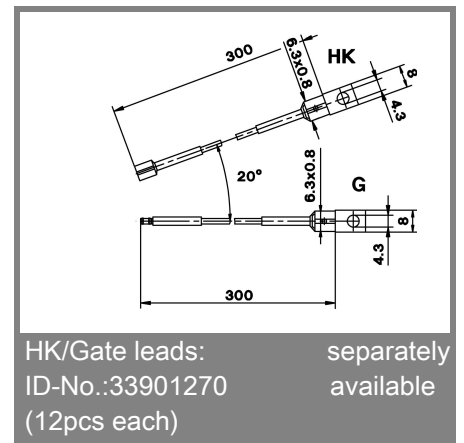
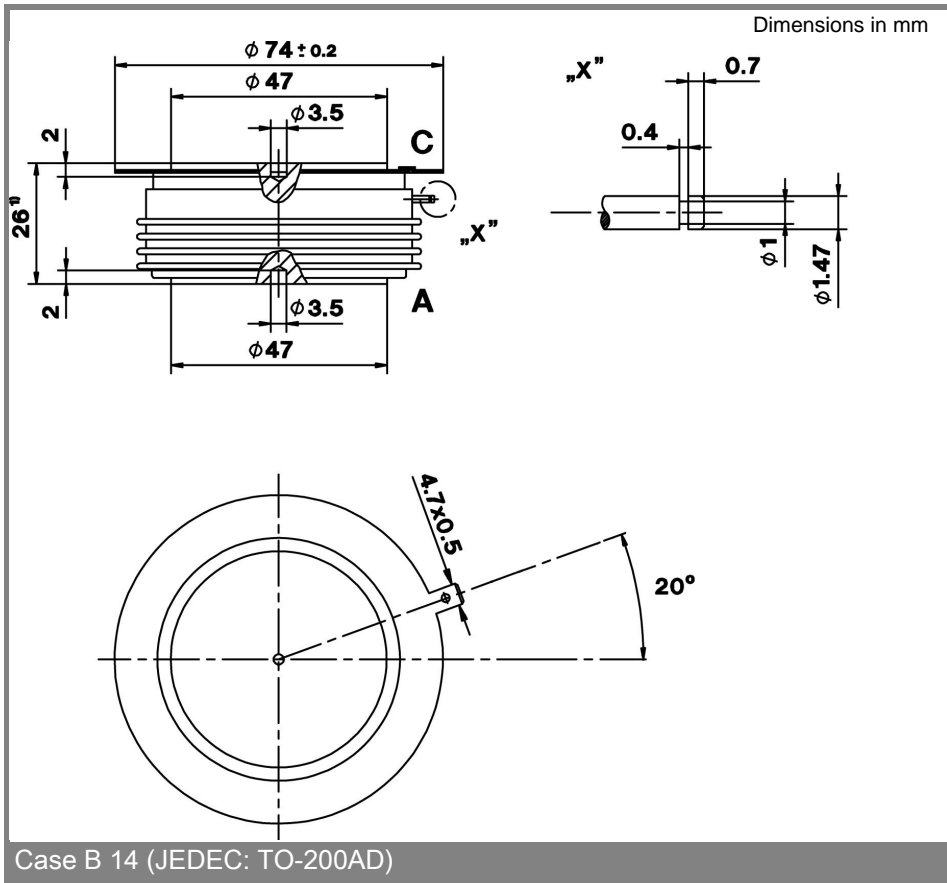
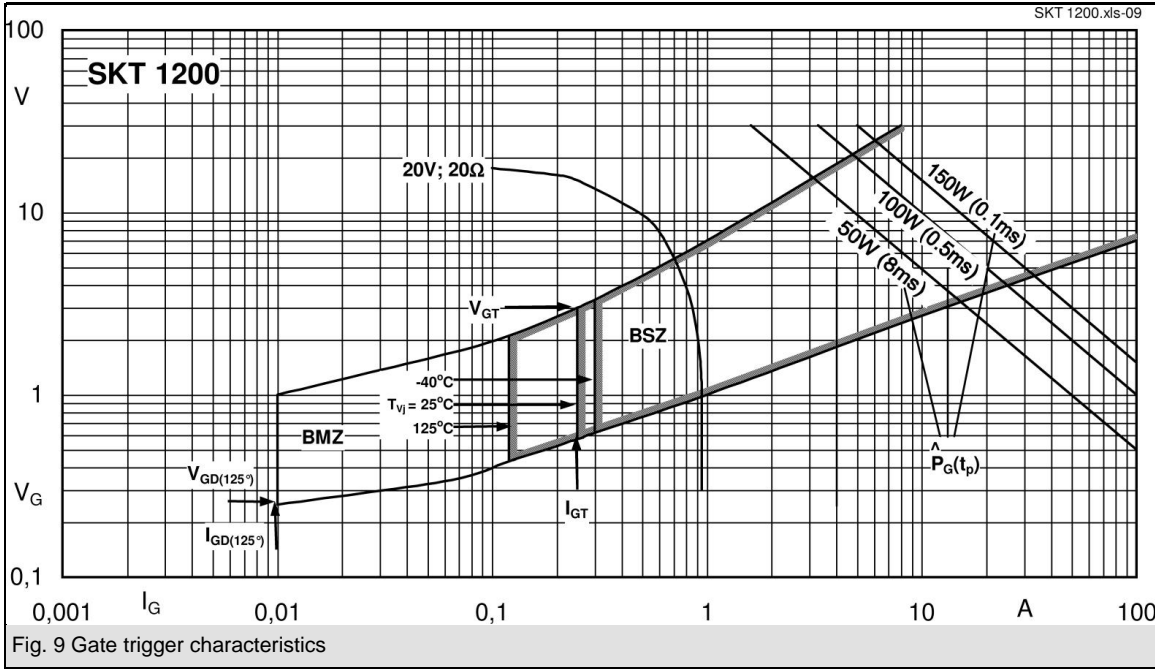

Fig. 4 Transient thermal impedance vs. time





This technical information specifies semiconductor devices but promises no characteristics. No warranty or guarantee expressed or implied is made regarding delivery, performance or suitability.